

*Golden Leaf
Automotive*



**2023
NOVA**

Nova Index

A

Accelerator Pedal Pad & Trim: 48
A/C Center Vent: 15
Antennas: 45
Arm Rest Bases: 51, 52

B

Back Up Lamps: 45
Back-up Lens: 44
Battery Tray Clamp: 3
Battery Trays: 3
Billet Hood Hinge: 11
Body / Extension Moldings: 41
Body Bushing Kit: 60
Body Shims & Washers: 7
Body Side Moldings: 41
Brake Backing Plates (Front Disc): 59
Brake & Clutch Pedal Pivot: 48
Brake Pedal Pads & Trim: 47, 48
Bucket Seat Track Assembly: 54
Bumper Bracket: 2
Bumper Bolt Kit: 2
Bumper Fillers: 2
Bumpers & Components: 1, 2

C

Cigarette Lighter: 58
Clothes/Harness Hooks: 56
Clutch Pedal Pad & Trim: 47
Control Arm Bumper: 5
Control Arms: 5
Cowl Grille: 14
Cowl Panels: 13, 14
Cowl Shoulder: 14
Cowl Vent Grille: 13
Cross Brace, Rear: 18
Cross Rail, Rear: 18
Crossrail / Rear Side Filler: 18

D

Dash A/C Vent: 15
Dash A/C Vent Bezel: 15
Dash & Glovebox: 14, 15
Dash Panel Assembly: 15
Dash Panels & Components: 14, 15
Deck Filler Panels: 30
Doghouse Assembly, Complete: 8
Dome Light Bases & Lenses: 59
Door Catch Assembly: 24
Door Frame Assembly: 23
Door Glass: 46, 47
Door Glass Assembly: 47
Door Handle, Interior: 27
Door Handle Push Button Kit: 26

Door Handles, Exterior: 25, 26
Door Hinge Rollers: 25
Door Hinges: 25
Door Inner Molding: 51
Door Latches: 24
Door Latch Relay: 25
Door Lock Knobs: 51
Doors & Hardware: 23, 24, 25, 26, 27
Door Shell: 23
Door Sill Decal: 60
Door Frame Moldings: 40
Door Glass: 46
Door Sill Scuff Plates: 52
Door Skins: 24
Door Trims & Arm Rests: 51, 52
Door Window Track, Lower: 25
Drip Rail Moldings: 39
Drum Brake Pedal Pad: 48

E

Electrical, Exterior: 43, 44, 45
Electrical, Interior: 57, 58, 59
Emblems: 42, 43
Engine Compartment: 4
Engine Mounts: 4
Eyebrow Moldings: 37

F

Fan: 4
Fenders, Front: 7, 8
Fender to Valance Brackets: 3
Firewall: 13
Firewall to Floor Braces: 13
Floor Brace: 18
Floor Brace Under RR Seat: 18
Floor Cover (For Man. Trans.): 16
Floor Pans & Components: 16, 17, 18
Floor Pan Shifter Pod: 16
Floor Pan Plug: 16
Floor Rear Seat Panel: 18
Frame Rails & Braces: 21
Fuel Caps: 35
Fuel Senders: 33, 34
Fuel Sending Unit Components: 34
Fuel Sending Unit Float: 34
Fuel Sending Unit Gasket: 34
Fuel Sending Unit Locking Ring: 34
Fuel Tanks: 32, 33
Fuel Tank Straps & Braces: 35

G

Gas Pedal Support: 48
Glass: 46, 47
Glove Box Door: 14
Glove Box Locks: 62, 63

Glove Box & Trunk Kits: 64, 65
Grilles & Components: 36, 37
Grille Support: 37

H

Hazard Switch Knob: 15
Headlamp Bezel: 36, 37
Headlamp Buckets: 36
Headlamp Dimmer Switch: 59
Headlamp Mounting: 36
Headlamp Retaining Ring: 37
Headlamp Switches: 59
Headlight Switch: 59
Headliner Clips: 22
Heater Blower Motor: 45
Heater Blower Motor Resistor: 45
Heater Boxes & Core: 45
Heater Case: 45
Heating Components: 45
Hood Hinge: 11, 12
Hood Hinge Spring: 13
Hood Latch Assembly: 12
Hood Latch Striker: 12
Hood Latch Support: 12
Hood Louver Bezel: 13
Hood Louver Brackets: 13
Hood Louvers: 13
Hoods & Components: 9, 10, 11, 12, 13
Hood & Valance Molding: 38
Hood Spear: 38
Horn Buttons: 50
Horn Contacts: 50
Horns: 58

I

Ign.,Door,Glove,Trunk: 61, 62
Ignition & Door Lock Kits: 60, 61
Ignition,Door & Trunk: 60
Ignition Locks: 63, 64
Ignition Switch: 58
Inner Roof Panel Brace: 22

L

License Plate Bracket: 32
License Plate Frames: 32
License Plate Lamp: 45
Locks: 60, 61, 63, 64

M

Magnum Alloy Wheels: 56
Mirror Mounting Kit, Exterior: 38
Mirrors, Exterior: 38
Mirrors, Interior: 50

P

Parking Brake Pads & Trim: 48
Parking Brake Release Handle: 48
Parking Lamp Assy., Bezels & Lenses: 43, 44
Parking Lamp Extension Moldings: 41
Pedal & Shifter Components: 47, 48
Pillar Panels: 22
Pitman Arm: 5

Q

Quarter Glass: 46
Quarter Inner Trim: 56
Quarter Moldings: 42
Quarter Panels: 27, 28, 29
Quarter Panel Skin: 28
Quarter Patch Panel: 29

R

Radiator Supports: 3, 4
Radio Bezel: 14
Rear Body Panel: 30
Rear Deck Lid: 30
Rear & Quarter Window Moldings: 41, 42
Rear Seat Floor Pan: 18
Rear View Mirror Bracket: 51
Rocker Panel Clips: 40
Rocker Panels: 20
Rocker Panel Moldings: 40
Roof Drip Rails: 22
Roof Headliner Retainer: 22
Roof Panel & Components: 21, 22

S

Seat Back Locking Knob: 54
Seat Belt Buckle Cover: 54
Seat Belts: 55
Seat Frame Supports: 54
Seats & Components: 53, 54
Seats Frames & Springs: 53, 54
Seat Track Adjusting Knob: 54
Seat Track Assembly: 54
Shifter Assembly: 48
Shock Tower & Apron Assembly: 9
Shock Tower Cap, Upper Seat & Saddle: 9
Shock Tower & Components: 8, 9
Shoulder Harness Hooks: 56
Side Marker Lens Assembly: 44
Side Markers & Bezels: 45
Spindle Kit: 6
Stabilizer Rod & Bushing: 5
Steel Dash Panel: 15
Steering Wheel Hub: 50

Steering Wheels & Components: 49, 50
Subframe Assembly: 6
Sun Visor Supports: 50
Suspension: 5, 6

T

Tail Lamp Assembly: 44
Tail Lamp Panels & Components: 31
Tail Lamps: 44
Tail Lamp Mounting Panels: 31
Transmission Mount Crossmember: 16
Trunk Cove Molding: 42
Trunk Divider / Package Shelf: 19
Trunk Floor Drop Off: 20
Trunk Floor Pans, Extensions & Braces: 19, 20
Trunk Latch Anchor Plate: 31
Trunk Lids, Latches & Hinges: 30, 31
Trunk Lid Torsion Rod & Seal: 30
Trunk Locks & Kit: 64
Trunk Molding: 42

V

Valve Covers: 4
Vent Window Crank: 27
Vent Window Glass: 46
Vinyl Top Molding: 42

W

Wheel Cap Retainer: 41
Wheel Center: 41
Wheelhouses: 29
Wheel Opening Moldings: 40, 41
Window Crank: 26, 27
Window Moldings, Rear & Qtr.: 41, 42
Window Track, Lower: 25
Windshield Glass: 46
Windshield Moldings: 39
Windshield Washer Bottle Bracket: 4
Windshield Wiper Switch: 57
Wiper Trans. Arms: 39



General Motors Trademarks
are used under License to
Dynacorn International Inc.

NOVA

Bumpers & Components

1608

1962-64 Front Bumper, w/o Park Lamps



1613

1970-72 Front Bumper, Chrome



1608A

1965 Front Bumper, w/ Park Lamps



1609

1962-65 Rear Bumper



1610

1966-67 Front Bumper, Chrome



1611

1966-67 Rear Bumper, Chrome



1612

1968-69 Front Bumper, Chrome



1614

1968-72 Rear Bumper, Chrome



Bumpers & Components

1615A
1962-65 Front Bumper Filler



1615B
1966-67 Front Bumper Filler



1615C
1968-72 Front Bumper Filler



1615D
1968-72 Front Bumper Filler, Plastic



1610A
1962-72 Bumper Bolt Kit



1611A
1966-67 Rear Bumper Bracket, RH

1611B
1966-67 Rear Bumper Bracket, LH



1614A
1968-72 Front Bumper Bracket, RH, 2 Pcs.

1614B
1968-72 Front Bumper Bracket, LH, 2 Pcs.



1614C
1968-72 Rear Bumper Bracket, RH

1614D
1968-72 Rear Bumper Bracket, LH



NOVA

Fender to Valance Brackets

1616A
1962-65 Fender to Valance Brackets, Pair



1616B
1966-67 Fender to Valance Brackets, Pair



1616C
1968-74 Fender to Valance Brackets, 2 Pc. Set



Battery Tray

1620
1962-67 Battery Tray w/ Bracket



1621
1968-74 Battery Tray



1047E
1962-79 Battery Tray Clamp



1047EC
1962-79 Battery Tray Clamp, Stainless



Radiator Supports

1639A
1962-64 Radiator Support

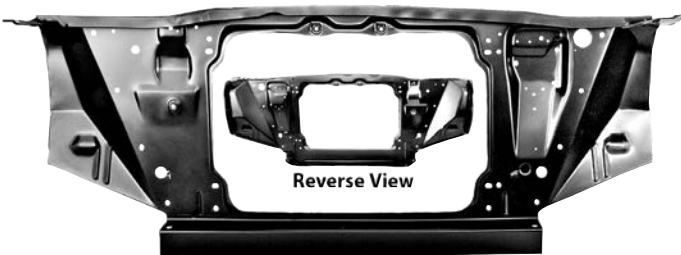

1640
1968-74 Radiator Support, For 6 Cylinder



1639B
1965 Radiator Support



1641
1968-72 Radiator Support, for 23" Radiator, All Engines



Radiator Supports

1639WT

1966-67 Radiator Support, EDP Coating



1639CWT

1966-67 Radiator Support-To-Frame-Rail Braces, Pair, Weld Through Primer



Underside View

Valve Covers

1015B

1962-74 Valve Covers, Painted Aluminum w/ Gaskets, Small Block, LT1 Style



1015

1962-74 Valve Covers, Polished Aluminum w/ Gaskets, Small Block, LT1 Style

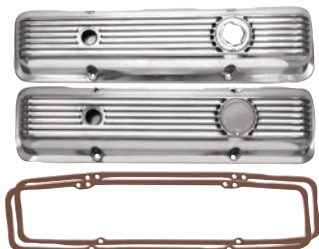

Engine Compartment

1425

1964-69 Windshield Washer Bottle Bracket



1625R

1962-67 Engine Mounts for 6 Cylinder



1048F

1968-72 Engine Mount, RH, Small Block V8

1048G

1968-72 Engine Mount, LH, Small Block V8



1048F

M1017

1968-72 Fan, 7 Blade



Suspension

1638

1963-67 Pitman Arm, Manual Steering



1638A

1962-67 Upper Control Arm, RH

1638B

1962-67 Upper Control Arm, LH



1003F

1968-74 Upper Control Arm, RH, OE Design

1003G

1968-74 Upper Control Arm, LH, OE Design



1003J

1968-74 Upper Control Arm, RH (Tubular)

1003K

1968-74 Upper Control Arm, LH (Tubular)



1638C

1964-67 Lower Control Arm, RH

1638D

1964-67 Lower Control Arm, RH



1003H

1968-74 Lower Control Arm, RH (Tubular)

1003I

1968-74 Lower Control Arm, LH (Tubular)



1003D

1968-74 Lower Control Arm, RH, OE Design

1003E

1968-74 Lower Control Arm, LH, OE Design



1621T

1968-72 Stabilizer Rod & Bushing

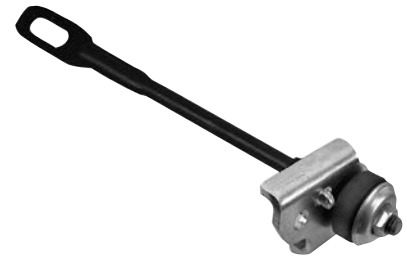

1007

1968-74 Upper Control Arm Bumper



1007A

1968-74 Lower Control Arm Bumper



Suspension

1003C

1968-74 Spindle Kit w/ Disc Brake Hardware



Sub-frame Assembly

1000T



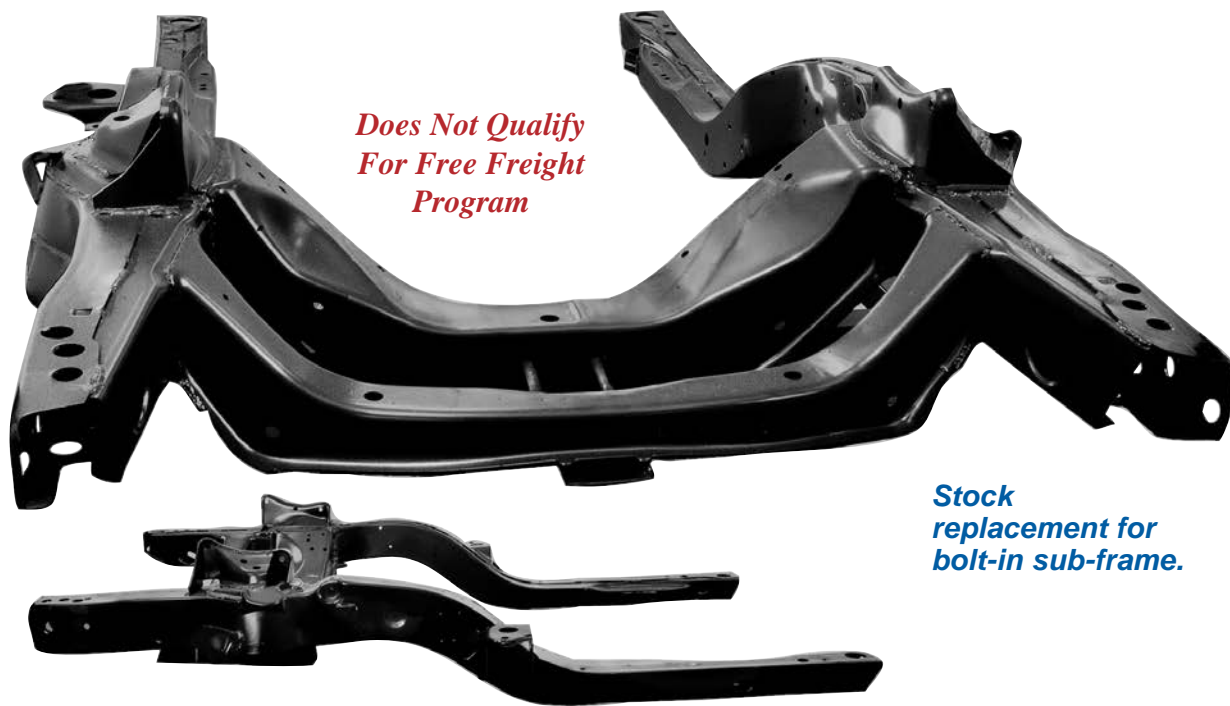

1968-72 Sub-frame Assy



*Does Not Qualify
For Free Freight
Program*

*Stock
replacement for
bolt-in sub-frame.*

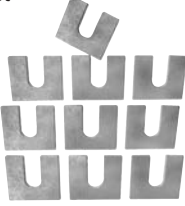
NOVA

Body Shims			
<p>1000F 1964-72 Body Shims, 6 mm., 10 Pc. Set</p> 	<p>1000D 1964-72 Body Shims, 3 mm., 10 Pc. Set</p> 	<p>1000E 1964-72 Body Shims, 1.6 mm., 10 Pc. Set</p> 	<p>GM03 1964-73 Body Washers, 20 Pc. Set</p> 

Front Fenders	
<p>1618 1962-65 Front Fender, RH</p> <p>1619 1962-65 Front Fender, LH</p>  <p style="text-align: center;">1618</p>	<p>1619C 1967 Front Fender, RH <i>NEW TOOLING!</i></p> <p>1619D 1967 Front Fender, LH <i>NEW TOOLING!</i></p>  <p style="text-align: center;">1619C</p>
<p>1619A 1966 Front Fender, RH</p> <p>1619B 1966 Front Fender, LH</p>  <p style="text-align: center;">1619A</p>	<p>1616 1968-69 Front Fender, RH</p> <p>1617 1968-69 Front Fender, LH</p>  <p style="text-align: center;">1616</p>

Front Fenders

1617A
1970-74 Front Fender, RH

1617B
1970-74 Front Fender, LH



1626
1968-72 Front Inner Fender, RH

1627
1968-72 Front Inner Fender, LH



Shock Tower & Components

1625SWT
1966-67 Complete Doghouse Assembly, Weld Through Primer



Shock Tower Closeup

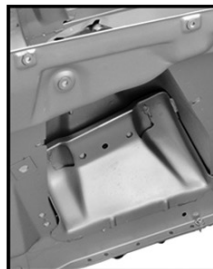

Shock Tower Reverse View

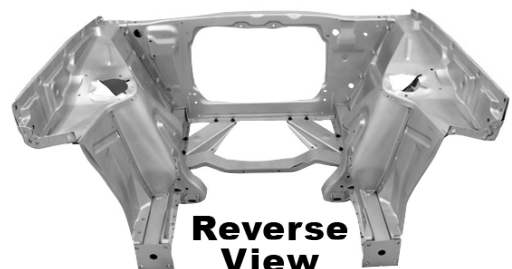

Reverse View

NOVA

Shock Tower & Components

1625Y

1966-67 Shock Tower & Apron Assembly, RH

1625Z

1966-67 Shock Tower & Apron Assembly, LH

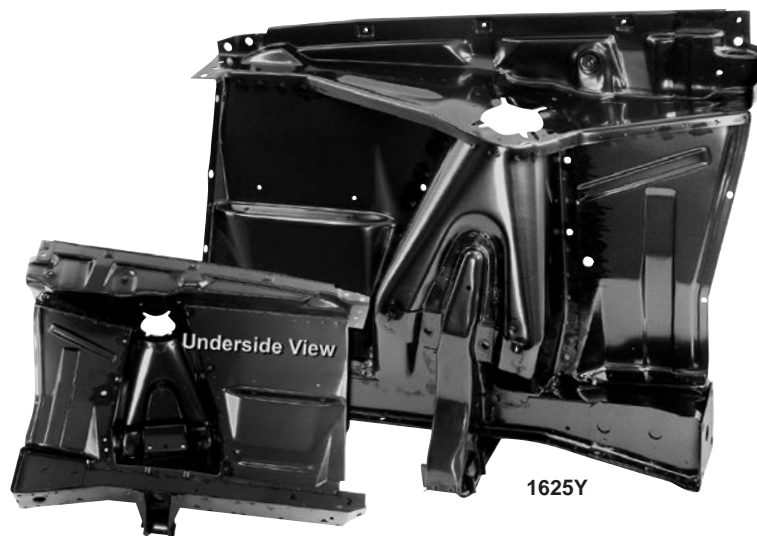

1625X

1962-67 Shock Tower Cap



1625W

1962-67 Spring Upper Seat



1625U

1962-67 Spring Saddle



Hoods & Components

1602

1962-65 Hood



1602A

1962-65 Hood w/ 2" Cowl Induction



Hoods & Components

1600
1966-67 Hood



1603
1968-72 Hood w/ 2" Cowl

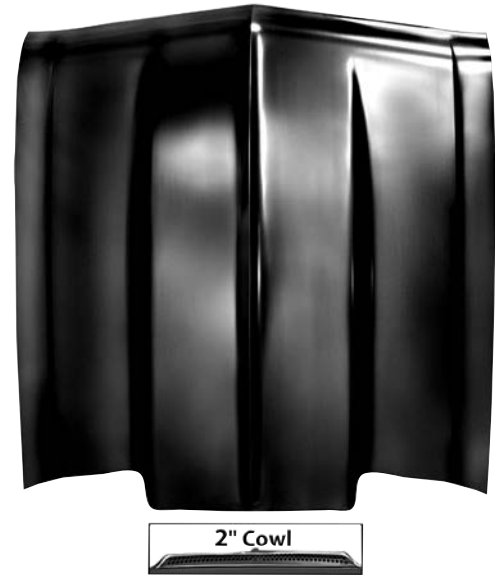

1600A
1966-67 Hood w/ 2" Cowl



1601
1968-72 Hood

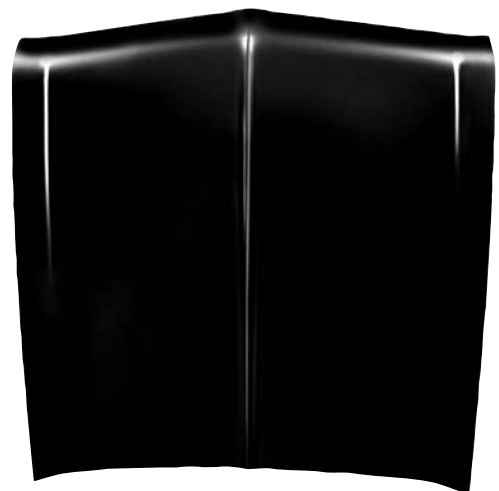

Hoods continued on next page

NOVA

Hoods & Components

1603B
1973-74 Hood w/ 2" Cowl



1603A
1968-72 Hood w/ 4" Cowl



BH30
1963-65 Billet Hood Hinge, Pair



BH01
1966-67 Billet Hood Hinge, Pair

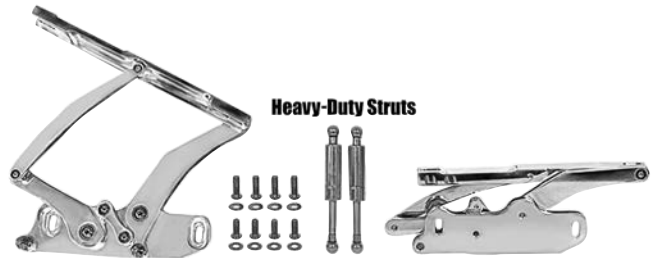

BH12
1968-79 Billet Hood Hinge, Pair

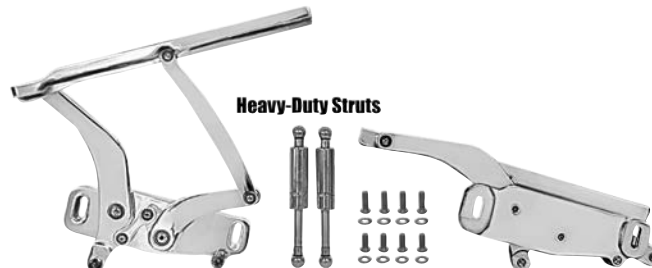

Hoods & Components

1701A
1963-65 Hood Hinge, RH

1701B
1963-65 Hood Hinge, LH



1068G
1966-67 Hood Hinge, RH

1068H
1966-67 Hood Hinge, LH



1464Y
1968-79 Hood Hinge, RH

1464Z
1968-79 Hood Hinge, LH



1643B
1966 Hood Latch Assembly



1643C
1968-72 Hood Latch Assembly

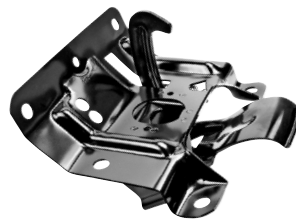

1602C
1963-64 Hood Latch Support



1643
1966 Hood Latch Support



1643A
1968-72 Hood Latch Support



1643D
1967 Hood Latch Support



1643CA
1968-72 Hood Latch Striker



1602B
1962-65 Hood Latch Striker



1602BA
1966-67 Hood Latch Striker



NOVA

Hoods & Components

1069AZ

1966-79 Hood Hinge Spring



1069AY

1963-64 Hood Hinge Spring



1601A

1968-72 Hood Louver Brackets, "SS"

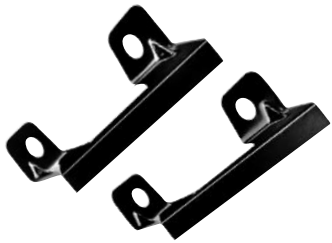

1069H

1968-72 Hood Louver Bezel, "SS"



1069F

1968-72 Hood Louvers, "SS"

For "SS" Models



Firewalls

1645WT

1962-67 Firewall, Weld Through Primer



1645AWT

1966-67 Firewall to Floor Braces, Weld Through Primer



Cowl Panels

1644WT

1966-67 Cowl Vent Grille, Weld Through Primer

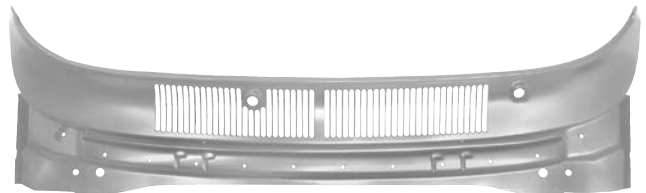

1642L

1968-74 Cowl Vent Grille



Cowl Panels

1642DWT

1966-67 Lower Cowl Grille, Weld Through Primer



1642K

1968-72 Lower Cowl Panel



1642WT

1962-67 Outer Cowl Panel, Weld Through Primer, RH

1642AWT

1962-67 Outer Cowl Panel, Weld Through Primer, LH



1642BWT

1962-67 Cowl Shoulder, Weld Through Primer, RH

1642CWT

1962-67 Cowl Shoulder, Weld Through Primer, LH



Dash Panels & Components

1647

1966-67 Glove Box Door w/ Hinge



M1617

1966-67 Radio Bezel



NOVA

Dash & Components

M1035L

1968-70 Hazard Switch Knob, Chrome



1024

1969-72 Dash A/C Vent



1025

1969-72 Dash A/C Vent Bezel



1452K

1968-74 A/C Center Vent, Black w/ Trim



1642E

1966-67 Dash Panel Assembly



1642H

1968-72 Dash Panel Assembly



1068E

1968-74 Steel Dash Panel (Will Fit w/ Modifications)



1642J

1968-74 Steel Upper Dash Panel, OE Style



1068EE

1969 Steel Upper Dash Panel, Custom (No Holes)



Floor Pans & Components

1636G

1962-67 Floor Pan Shifter Pod,
For Automatic Transmission



1047F

1962-72 Floor Pan Plug



1625P

1966-67 Transmission Mount Crossmember, V8
(Between Sub-frame)



1636B

1962-67 Floor Cover, For Manual Transmission



1630WT

1962-67 Floor Pan Full, RH

1631WT

1962-67 Floor Pan Full, LH

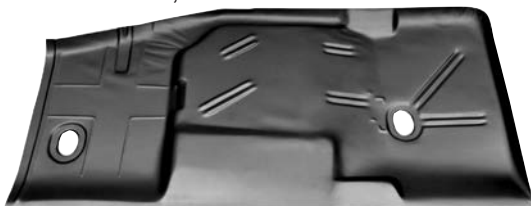

1631WT

1636WT

1962-67 Complete Floor Pan, Weld Through Primer,
(2 Door) Auto. Trans.



1636AWT

1962-67 Complete Floor Pan, Weld Through Primer,
(2 Door No Hole)
For Column Shifter Cut Out for Manual Transmissions.

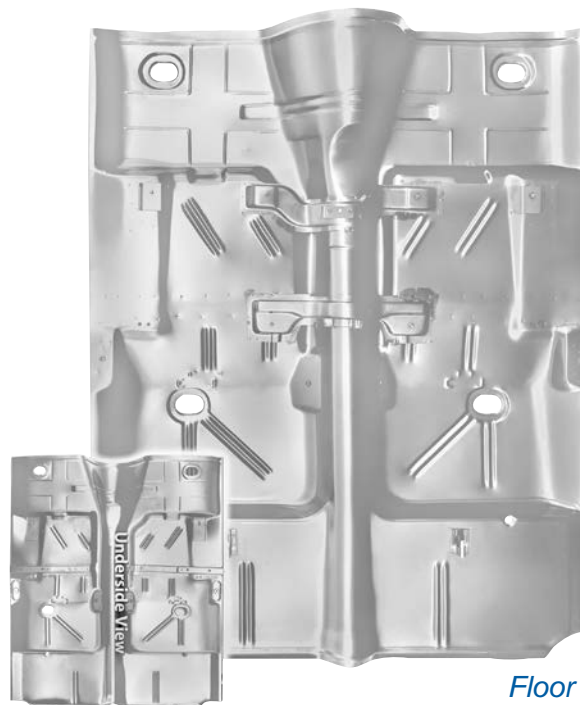

*Floor Pans
continued on next page*

NOVA

Floor Pans & Components

1636AFWT

1966-67 Complete Floor & Trunk Pan (No Rocker Panels), Weld Through Primer

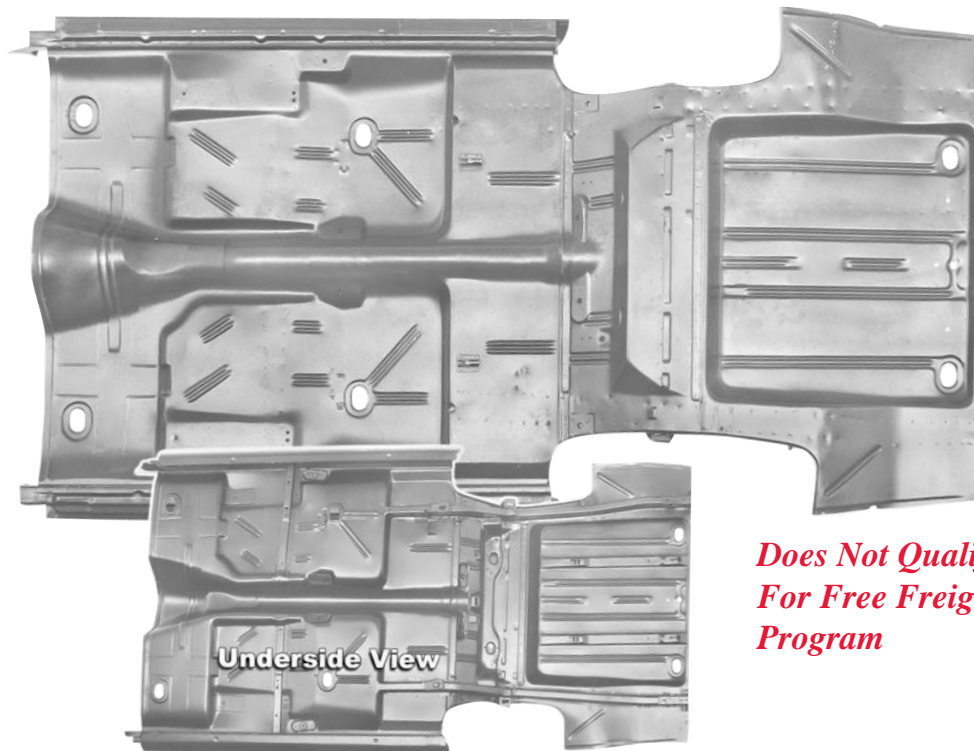

*Does Not Qualify
For Free Freight
Program*

1635A

1968-74 Complete Floor Pan



Floor Pans & Components

1634

1968-74 Full Floor Pan, RH

1635

1968-74 Full Floor Pan, LH



1634

1633ZE

1968-74 Floor Front Brace



1633ZC

1968-74 Floor Rear Brace, LH

1633ZD

1968-74 Floor Rear Brace, RH



1633ZD

1633G

1968-72 Rear Cross Rail



Rear Seat Floor Pan

1633Q

1968-72 Crossrail / Rear Side Filler, RH

1633R

1968-72 Crossrail / Rear Side Filler, LH

1633Q

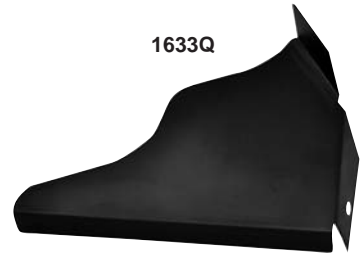

1632BA

1968-74 Floor Brace Under RR Seat, RH

1632BB

1968-74 Floor Brace Under RR Seat, LH

1632BB



1632BC

1968-74 Floor Rear Seat Panel, RH
w/ Seat Belt Bracket

1632BD

1968-74 Floor Rear Seat Panel, LH
w/ Seat Belt Bracket



1632BC

1632BWT

1962-67 Rear Seat Floor Pan w/ Braces

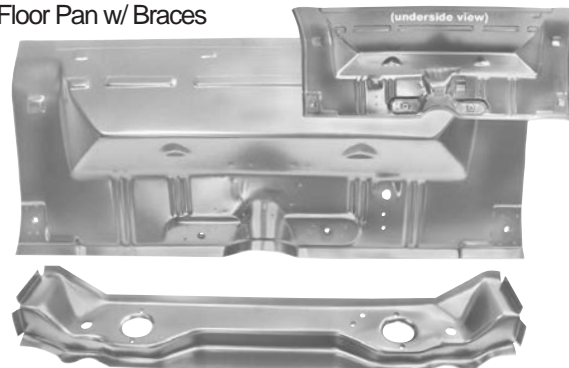

NOVA

Trunk Divider / Package Shelf

1632H

1966-67 Trunk Divider/Package Shelf

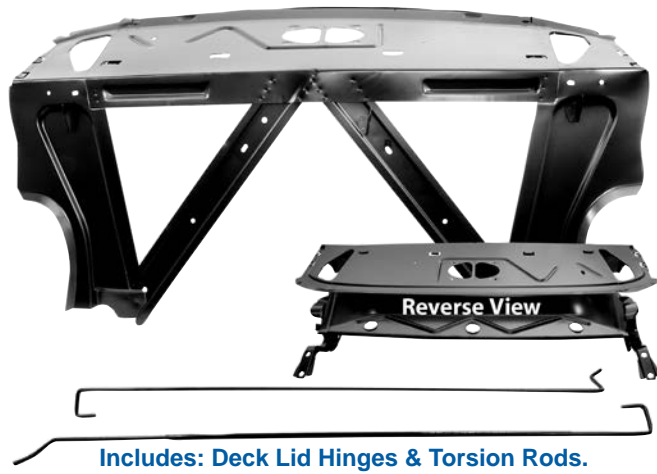

1632K

1966-67 Trunk Divider/ Package Shelf Supports

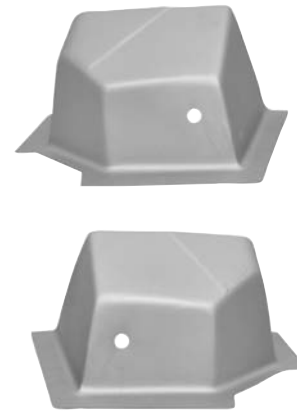

Trunk Floor Pans

1633C

1968-72 Trunk Floor Extension, RH

1633D

1968-72 Trunk Floor Extension, LH



1632WT

1962-67 Trunk Floor Pan, Weld Through Primer



1632AWT

1962-67 Complete Trunk Floor Pan w/ Straps, Weld Through Primer

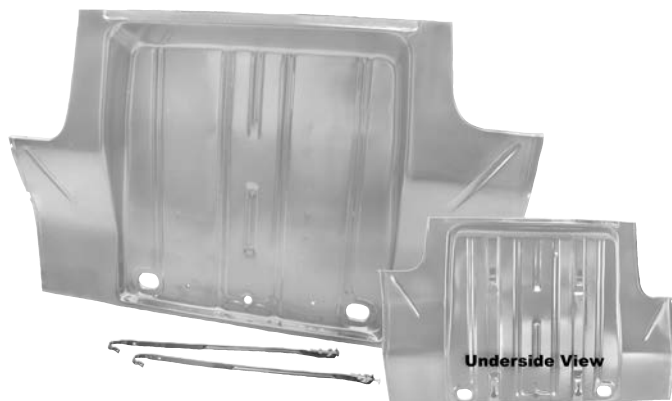

1633

1968-72 Trunk Floor Pan



Trunk Floor Pans

1633N

1968-70 Trunk Floor Complete w/ Braces

**1633P**

1971-72 Trunk Floor Complete w/ Braces

**1633L**

1962-65 Trunk Floor Drop Off, RH

1633M

1962-65 Trunk Floor Drop Off, LH



1633M

1633A

1966-67 Trunk Floor Drop Off, RH

1633B

1966-67 Trunk Floor Drop Off, LH

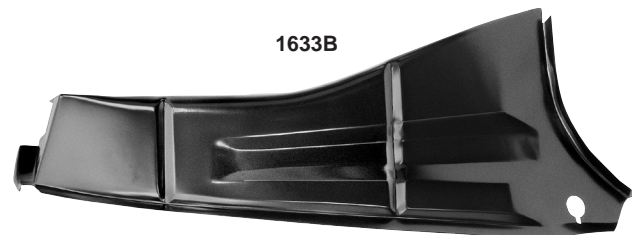

1633B

Rocker Panels

1660

1966-67 Complete Rocker Panel, RH

1661

1966-67 Complete Rocker Panel, LH



1660

1662

1968-79 Rocker Panel Outer, RH

1663

1968-79 Rocker Panel Outer, LH



1663

1664

1968-79 Rocker Panel Inner, w/ Reinforcements, RH

1665

1968-79 Rocker Panel Inner, w/ Reinforcements, LH



1664

Frame Rails & Braces

1632YWT

1966-67 Frame Rail, Weld Through Primer, RH

1632ZWT

1966-67 Frame Rail, Weld Through Primer, LH



1632YWT

1633ZA

1968-72 Frame Rail Assembly Rear, RH

1633ZB

1968-72 Frame Rail Assembly Rear, LH



1633ZA

1632EWT

1966-67 Front Frame Rail Brace, Weld Through Primer, RH

1632FWT

1966-67 Front Frame Rail Brace, Weld Through Primer, LH

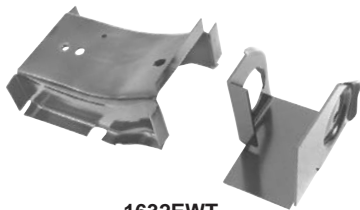

1632EWT

1632CWT

1966-67 Rear Frame Rail Brace, Weld Through Primer, RH

1632DWT

1966-67 Rear Frame Rail Brace, Weld Through Primer, LH



1632DWT

Roof Panel & Components

1669

1962-65 Roof Panel



1670

1966-67 Roof Panel



Roof Panel & Components

1671A
1966-67 Roof Headliner Retainer

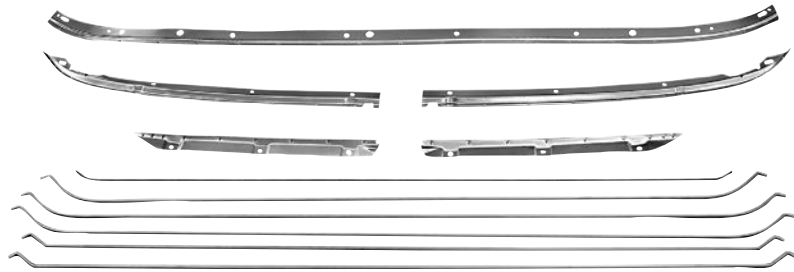

1671
1966-67 Inner Roof Panel Brace



1672
1966-67 Roof Drip Rails



Headliner Clips

M1418M
1968-72 Headliner Clips, 6 Pcs. / Kit, Large



Pillar Panels

1642FWT
1966-67 Windshield Pillar Panel, Weld Through Primer, RH
1642GWT
1966-67 Windshield Pillar Panel, Weld Through Primer, LH



1642FWT

NOVA

Quarter/Door Frame Assembly

1619PWT

1966-67 Quarter / Door Frame Assembly, Weld Through Primer, RH

1619QWT

1966-67 Quarter / Door Frame Assembly, Weld Through Primer, LH

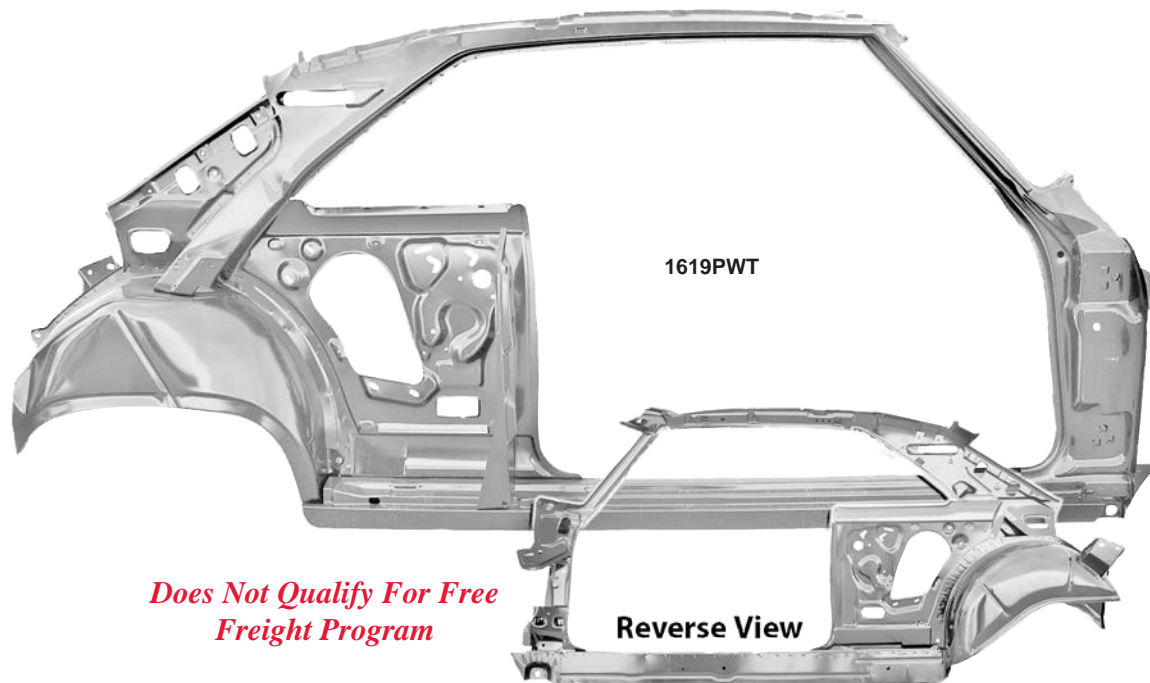

Doors & Hardware

1619J

1966 Door Shell, RH

1619K

1966 Door Shell, LH



1619J

1619L

1967 Door Shell, RH

1619M

1967 Door Shell, LH



1619L

Doors & Hardware

1621N
1962-65 Door Skin, RH

1621M
1962-65 Door Skin, LH



1621N

1621JWT
1966-67 Door Skin, Weld Through Primer, RH

1621KWT
1966-67 Door Skin, Weld Through Primer, LH



1621JWT

1623C
1968-72 Door Skin, RH

1623D
1968-72 Door Skin, LH

Mirror Holes Closeup



1623D

1757
1963-67 Door Catch Assembly, Pair



1621R
1966-67 Door Latch, RH (1963-65 w/ Modification)

1621S
1966-67 Door Latch, LH (1963-65 w/ Modification)

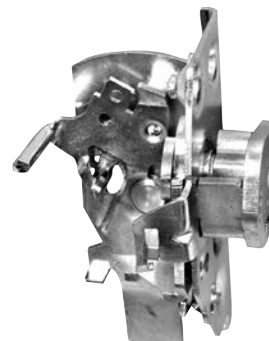

1621R

8720401
1969-70 Door Latch, RH

8720402
1969-70 Door Latch, LH

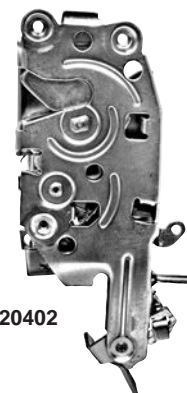

8720402

NOVA

Doors & Hardware

1621P

1966 Door Latch Relay, RH
(1962-65 w/ Modification)

1621Q

1966 Door Latch Relay, LH
(1962-65 w/ Modification)

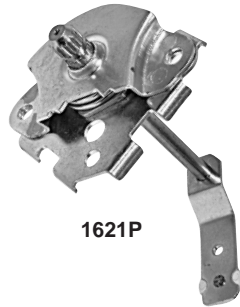

1621Y

1967 Door Latch Relay, RH

1621Z

1967 Door Latch Relay, LH

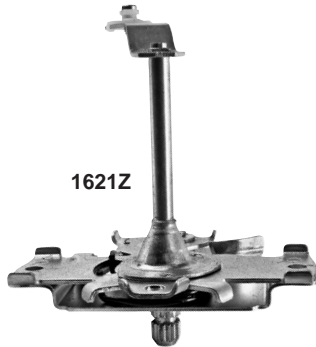

M1608

1962-65 Lower Window Track, RH

M1608A

1962-65 Lower Window Track, LH

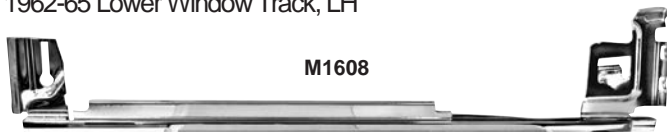

1076FA

1969-79 Upper Door Hinge, RH

1076FB

1969-79 Upper Door Hinge, LH



1076FC

1969-79 Lower Door Hinge, RH

1076FD

1969-79 Lower Door Hinge, LH



1623E

1968-72 Door Hinge Rollers



M1600

1962-65 Exterior Door Handles



M1601A

1962-65 Exterior Door Handle Push Button Kit



M1600A

1966-67 Exterior Door Handles

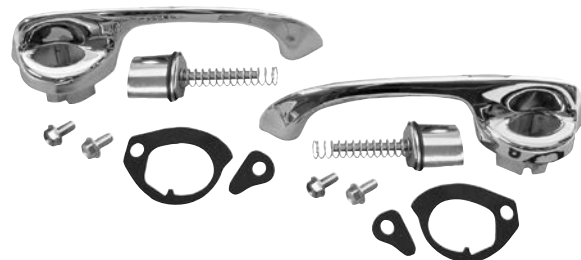

M1602B

1966-67 Exterior Door Handle Push Button Kit



Doors & Hardware

M1601

1968-79 Exterior Door Handles



M1037C

1968-79 Exterior Door Handle Push Button Kit



M1392A

1962-64 Window Crank, Double Arm, Black Knob (Chevy II/ Nova SS) (Also 1967 Nova)



M1392B

1964 Window Crank, Double Arm, Chrome Knob



M1392C

1964 Window Crank, Single Arm, Black Knob

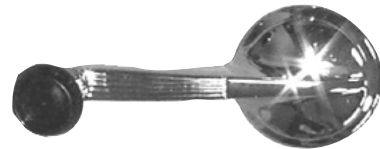

M1392D

1964 Window Crank, Single Arm, Black Knob w/ Chrome Button



M1776

1965-66 Window Crank, Black Knob



M1382A

1967 Window Crank, Black Knob



NOVA

Doors & Hardware

M1392N

1967 Vent Window Crank, Black Knob



M1037A

1968 Window Crank, Black Knob



M1037B

1968-70 Window Crank, Clear Knob



M1604

1962-64 Interior Door Handle, Double Arm



M1037F

1965-67 Interior Door Handle, Std., Single Arm



M1037D

1968-74 Interior Door Handle, RH, Standard

M1037E

1968-74 Interior Door Handle, LH, Standard



Quarter Panels

1621AWT

1962-65 Full Quarter Panel, Weld Through Primer, RH

1621BWT

1962-65 Full Quarter Panel, Weld Through Primer, LH



1621W

1966-67 Full Quarter Panel With Sail, RH

1621X

1966-67 Full Quarter Panel With Sail, LH

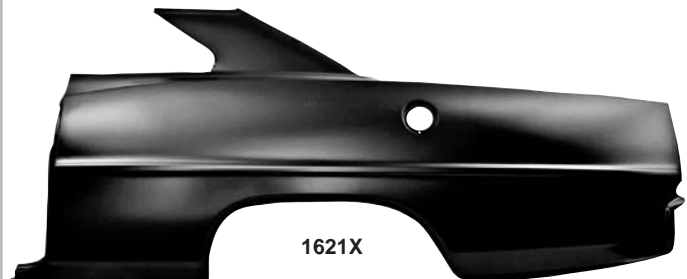

Quarter Panels

1622

1968-69 Quarter Panel Full w/ Sail, RH

1623

1968-69 Quarter Panel Full w/ Sail, LH



1623

1623A

1970-72 Quarter Panel Full w/ Sail, RH

1623B

1970-72 Quarter Panel Full w/ Sail, LH



1623B

1623F

1968-69 Quarter Panel Skin, RH

1623G

1968-69 Quarter Panel Skin, LH



1623G

1623H

1970-72 Quarter Panel Skin, RH

1623J

1970-72 Quarter Panel Skin, LH



1623J

1623P

1973-74 Quarter Skin, RH

1623Q

1973-74 Quarter Skin, LH



1623Q

1623R

1975-79 Quarter Skin, RH

1623S

1975-79 Quarter Skin, LH



1623R

NOVA

Quarter Panels

1621G

1966-67 Quarter Patch Panel, Lower Rear, RH

1621H

1966-67 Quarter Patch Panel, Lower Rear, LH



1621H

1628A

1966-67 Outer Wheelhouse, RH

1628B

1966-67 Outer Wheelhouse, LH



1628A

Wheelhouses

1627A

1962-65 Outer Wheelhouse, RH

1627B

1962-65 Outer Wheelhouse, LH



1627A

1629C

1968-72 Inner Wheelhouse, RH

1629D

1968-72 Inner Wheelhouse, LH



1629C

1628CWT

1966-67 Complete Wheelhouse, Weld Through Primer, RH

1628DWT

1966-67 Complete Wheelhouse, Weld Through Primer, LH



1628DWT

(1628DWT
end view)

1629A

1968-74 Outer Wheelhouse, RH

1629B

1968-74 Outer Wheelhouse, LH



1629A

Deck Filler Panels

1623ZWT

1966-67 Rear Body Panel, Weld Through Primer

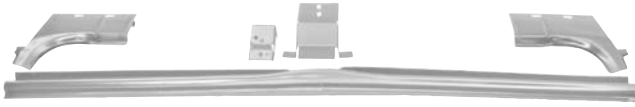

1615WT

1966-67 Deck Lid Filler Panel, Weld Through Primer



1615EWT

1968-72 Deck Lid Filler Panel, EDP Coating



Trunk Lids & Components

1603X

1962-64 Rear Deck Lid



Underside View

1603Y

1965 Rear Deck Lid



Underside View

1604

1966-67 Trunk Lid



1605

1968-74 Trunk Lid (Except Hatchback)



1604B

1966-67 Trunk Lid Hinges



1606

1966-67 Trunk Lid Torsion Rod



1604A

1966-67 Trunk Lid Rubber Seal



NOVA

Trunk Lids & Components

M1019
1962-70 Trunk Latch



M1019A
1971-74 Trunk Latch



1625
1970-72 Tail Lamp Panel



1621EA
1962-65 Tail Lamp Center Panel



1621C
1962-64 Tail Lamp Mounting Panel, RH 2 Door,
65 (w/ Modifications)

1621D
1962-64 Tail Lamp Mounting Panel, LH 2 Door,
65 (w/ Modifications)



1621D

1621E
1962-64 Tail Lamp Panel Assembly



1623YWT
1966-67 Complete Tail Lamp Panel, Weld Through Primer



1621U
1966-67 Tail Lamp Mounting Panel, RH

1621V
1966-67 Tail Lamp Mounting Panel, LH



1621V

1624
1968-69 Tail Lamp Panel



1649
1968-72 Trunk Latch Anchor Plate



Lic. Plate Brkt.

1078A
1970-74 License Plate Bracket



License Plate Frames

LF64
1964 License Plate Frames
LF71
1971 License Plate Frames
LF72
1972 License Plate Frames

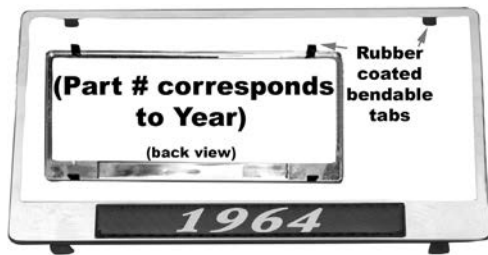

WHILE SUPPLIES LAST!

Fuel Tanks

T27
1962-67 Fuel Tank, 16 Gallon



T27A
1968-70 Fuel Tank w/o E.E.C.



T28
1970-72 Fuel Tank w/ E.E.C.,
16 Gallon



T28A
1971-72 Fuel Tank w/o E.E.C.



Fuel Tanks continued on next page

NOVA

Fuel Tanks

T28K

1973-74 Fuel Tank, w/ Neck, 21.5 Gallon



T28C

1975-79 Fuel Tank w/o Neck, 21 Gallon



Fuel Senders

T21A

1962-65 Fuel Sending Unit, 5/16" (Except 4 BBL)



T22A

1966-67 Fuel Sending Unit, 5/16"



T21B

1962-65 Fuel Sending Unit, 3/8"



T22

1966-67 Fuel Sending Unit, 4 BBL (M04)



Fuel Senders

T15
1968-69 Fuel Sending Unit, 5/16",
6 Cylinder (Locking Ring Included)

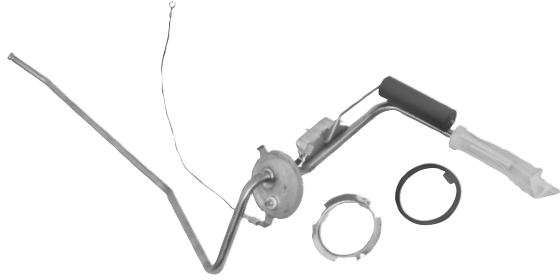

T16
1968-72 Fuel Sending Unit, 3/8", V8
1969 3/8", V8 & 2 BBL, 396

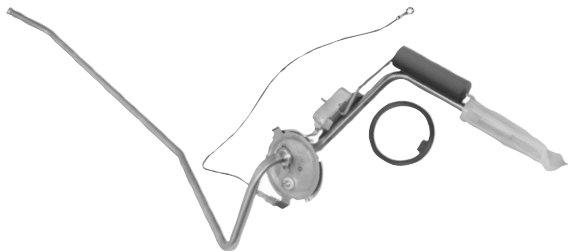

T17
1969-72 Fuel Sending Unit, For 350,
4 BBL, 3/8" & 1/4"

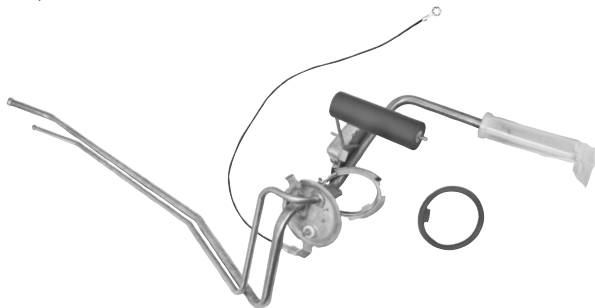

T18D
1976-79 Fuel Sending Unit, 3/8" Stainless



T18E
1976-79 Fuel Sending Unit, 3/8" & 1/4"
Stainless

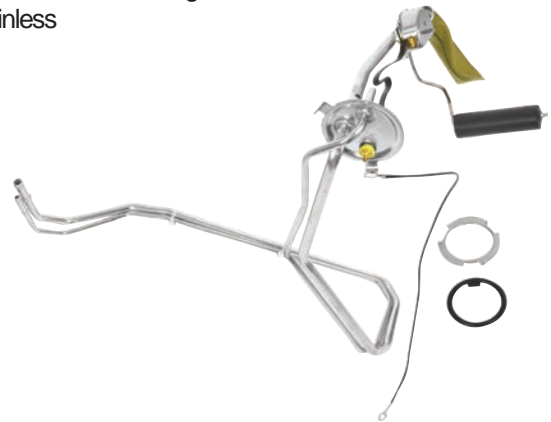

Fuel Sending Unit Components

T03C
1962-67 Fuel Sending Unit Float

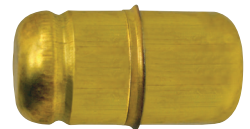

T20
1962-74 Fuel Sending Unit Locking Ring
T21
1962-74 Fuel Sending Unit Gasket



NOVA

Fuel Tank Straps & Braces

T28F

1962-67 Fuel Tank Straps, Painted



T28G

1962-67 Fuel Tank Straps, Stainless



T28B

1968-72 Fuel Tank Straps, Painted



T28BS

1968-72 Fuel Tank Straps, Stainless



T28H

1973-75 Fuel Tank Straps, Painted



T28J

1973-75 Fuel Tank Straps, Zinc Plated



T28D

1968-72 Fuel Tank Brace, RH

T28E

1968-72 Fuel Tank Brace, LH



Fuel Caps

1623K

1962-64 Fuel Cap, Chrome



1623L

1962-64 Fuel Cap, Black



T46

1968-70 Fuel Cap, Vented



1623M

1965-67 Fuel Cap, Chrome



1623N

1965-67 Fuel Cap, Black



Grilles & Components

L1604

1962-64 Headlamp Mounting, RH

L1605

1962-64 Headlamp Mounting, LH

**LH14 NEW**

1975-78 Headlamp Bucket, RH=LH

**L1600**

1966 Headlamp Bucket, RH

L1601

1966 Headlamp Bucket, LH

**3790350**

1962-64 Headlamp Bezel, RH

3790349

1962-64 Headlamp Bezel, LH

**L1602**

1967 Headlamp Bucket, RH

L1603

1967 Headlamp Bucket, LH

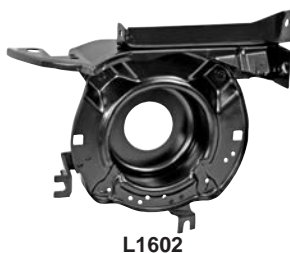
**3866885**

1966 Headlamp Bezel

**K892**

1968-73 Headlamp Bucket, RH

K893

1968-73 Headlamp Bucket, LH

**3892282**

1967 Headlamp Bezel, RH

3892281

1967 Headlamp Bezel, LH

*Headlamp Bezel continued on next page*

Grilles & Components

M1670

1968 Headlamp Bezels, Pair



M1671

1968-72 Headlamp Bezels, Pair



M1016

1962-75 Headlamp Retaining Ring



M1636

1968-72 Eyebrow Moldings



1641E

1968-72 Grille Support, RH

1641F

1968-72 Grille Support, LH



M1610

1966 Grille, Standard



M1611

1967 Grille, Standard



M1612

1968-69 Grille, Standard



M1613

1968-69 Grille, "SS"



M1614

1970-72 Grille, Standard



M1615

1970-72 Grille, "SS"

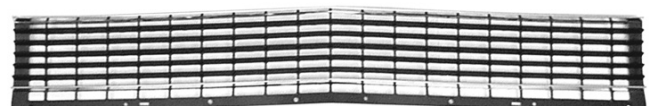

Exterior Mirrors

M1036B
1962 Exterior Mirror



M1035
1963-65 Exterior Mirror, Round w/ "Bow-tie"



3899857
1966-67 Exterior Remote Mirror



M1032
1966-72 Exterior Mirror, Round w/ "Bow-tie"



M1032A
1966-68 Exterior Mirror, Round w/o "Bow-tie"



Hood & Valance Molding

M1631
1962-64 Hood Spear



M1632
1966 Hood Molding



M1675
1966 Valance Panel Molding



M1630A
1967 Hood Molding



M1630
1968-72 Hood Molding

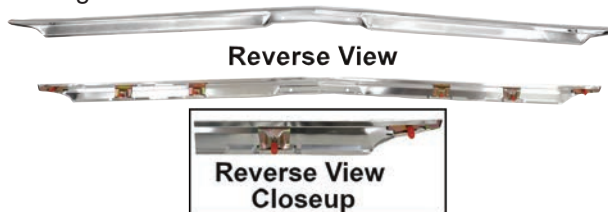

M1630B
1973-74 Hood Molding



M1030A
1967-69 Exterior Mirror Mounting Kit



3921816
1968 Exterior Remote Mirror, LH



M1030
1969-72 Exterior Mirror, RH, Rectangular

M1031
1969-72 Exterior Mirror, LH, Rectangular



Wiper Trans. Arms

1702T

1963 Wiper Motor Transmission Arm

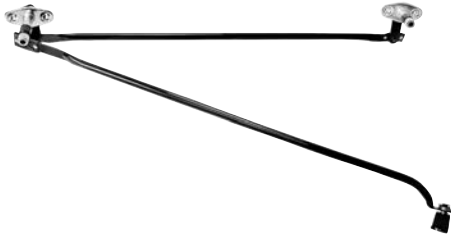

1702U

1964 Wiper Motor Transmission Arm

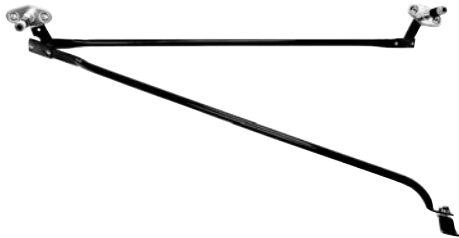

Windshield Moldings

M1650A

1962-67 Windshield Moldings, Hard Top, 4 Pcs.

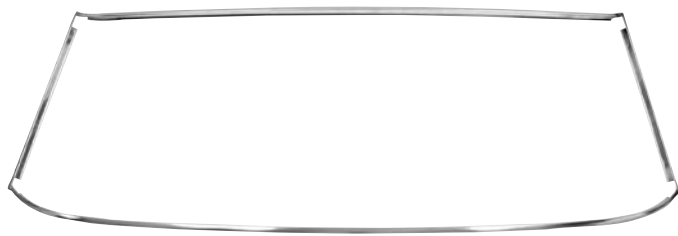

M1650B

1962-67 Windshield Moldings, Sedan, 4 Pcs.



M1650

1968-72 Windshield Moldings, 4 Pcs.



Drip Rail Moldings

M1626

1962-65 Drip Rail Moldings, 4 Pcs.



M1628

1966-67 Drip Rail Moldings, 2 Pcs.



M1629

1968-72 Drip Rail Moldings, 6 Pcs.



M1629A

1973-74 Drip Rail Moldings, 6 Pcs.



Door Frame Moldings

M1606

1968-72 Door Frame Moldings, 8 Pcs.

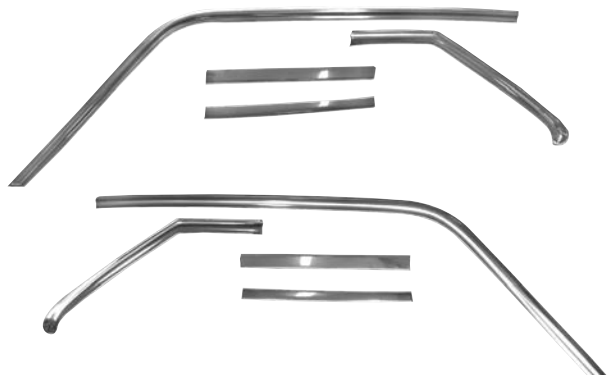

Rocker Panel Moldings

M1672

1966-67 Rocker Panel Moldings w/ 2 Sets of Clips, Pair

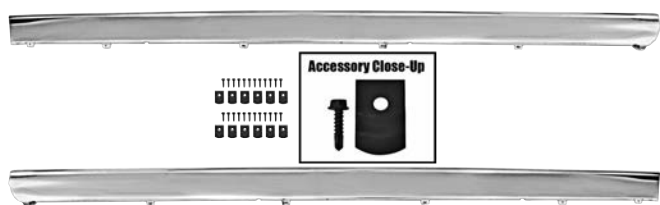

M1673

1968-74 Rocker Panel Moldings



M1674

1968-74 Rocker Panel Extension Moldings

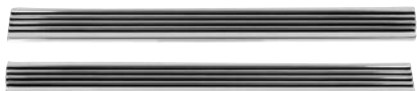

M1430CLP

1962-64 Rocker Panel Clips (Except SS), 6 Clips



Wheel Opening Moldings

M1659A

1962-65 Front Wheel Opening Molding, RH

M1659B

1962-65 Front Wheel Opening Molding, LH



M1660

1966-67 Front Wheel Opening Molding, RH

M1661

1966-67 Front Wheel Opening Molding, LH

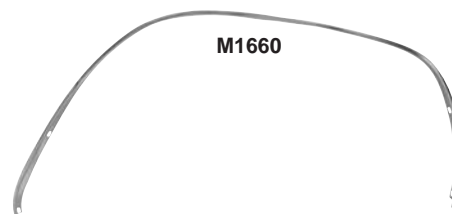

M1659C

1962-65 Rear Wheel Opening Molding, RH

M1659D

1962-65 Rear Wheel Opening Molding, LH



M1662

1966-67 Rear Wheel Opening Molding, RH

M1663

1966-67 Rear Wheel Opening Molding, LH



Wheel Opening Moldings continued on next page

Wheel Opening Moldings

M1664

1968-72 Rear Wheel Opening Molding, RH

M1665

1968-72 Rear Wheel Opening Molding, LH



M1666

1968-72 Rear Wheel Opening Molding, RH

M1667

1968-72 Rear Wheel Opening Molding, LH



M1345

1969-70 Wheel Cap Retainer

M1346

1969-70 Wheel Center

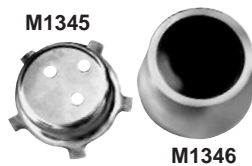

Body / Extension Moldings.

M1637

1962-64 Parking Lamp Extension Moldings



M1625

1968-72 Body Side Moldings for "SS"

M1625
8 pcs
(4 per side)

Closeup View

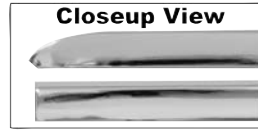

Rear & Quarter Window Moldings

M1650C

1962-65 Rear Window Moldings, 8 Pcs. Hard Top



M1652

1966-67 Rear Window Moldings, 5 Pcs.



M1651

1968-72 Rear Window Molding Set, 4 Pcs.



Rear & Quarter Window Moldings

M1685

1966-67 Quarter Window Moldings



Vinyl Top Molding

M1680

1968-72 Vinyl Top Molding Set 4 Pcs.



Trunk Molding

M1668

1962-65 Quarter Moldings



M1669

1962-65 Trunk Cove Molding



Emblems

4883156

1963 "Nova SS" Quarter Panel Emblem



3793606

1963-64 "Nova SS" Trunk Lid Emblem



EM3031

1965 "Nova SS" Quarter Panel Emblems



EM3032

1965 "Nova SS" Trunk Lid Emblem



EM3042

1966 "SS" Grille Emblem w/ Retainer



3874540

1966 "Chevy II" Grille Emblem



4539568

1966-67 "Chevy II" Door Panel Emblems



Emblems continued on next page

NOVA

Emblems

EM3047

1966-67 "Super Sport" Script Quarter Panel Emblems



3918871

1968-69 "SS" Grille Emblem



3940538

1970-72 "SS" Grille Emblem



EM3075

1968-69 "SS" Quarter Panel Emblem



M1635

1968-72 "SS" Rear Trim Emblem



EM3100

1973-74 "SS" Fender and Trunk Emblem



4226981

1966-67 "Nova Chevy II" Quarter Panel Emblem Standard



3953676

1968-72 "Nova" Front Fender Emblem



8728940

1968-72 "Nova by Chevrolet" Trunk Lid Emblem



3953840

1969-72 Hood Lip Emblem



7790751

1969-72 "Nova" Door Panel Emblems



EM3091

1970-72 "SS" Rear Panel with Emblem



EM3092

1970-72 Custom Rear Panel



Exterior Electrical

M1642

1963-64 Parking Lamp Lenses, Amber

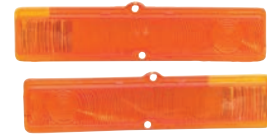

M1645

1968-69 Parking Lamp Lenses, Amber



M1647

1970 Parking Lamp Lenses, Clear

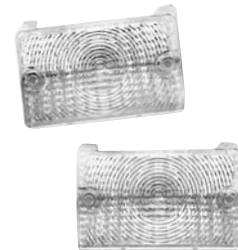

M1649

1971-72 Parking Lamp Lenses, Amber

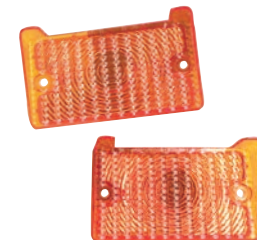

M1643

1962 Parking Lamp Lens Bezels



Exterior Electrical

C626451

1962-64 Back-up Lens, Clear



M1640

1962-64 Parking Lamp Assembly, RH

M1641

1962-64 Parking Lamp Assembly, LH

M1640



L1610

1966-67 Parking Lamp Assembly, RH

L1611

1966-67 Parking Lamp Assembly, LH



L1610

M1644

1968-69 Parking Lamp Assembly,
RH=LH, Amber



M1646

1970 Parking Lamp Assembly,
RH=LH, Clear



M1648

1971-72 Parking Lamp Assembly,
RH=LH, Amber



899439

1962-64 Tail Lamp Assembly



CTL6667LED

1966-67 LED Tail Lamp Assembly

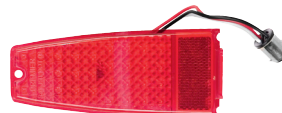

L1620

1968-69 Tail Lamp Assembly, RH

L1621

1968-69 Tail Lamp Assembly, LH

L1620

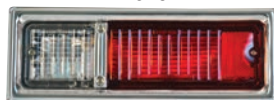

LTL6826LED

1968-69 Tail Lamp Assembly, RH



L1622

1970-71 Tail Lamp Assembly, RH

L1623

1970-71 Tail Lamp Assembly, LH

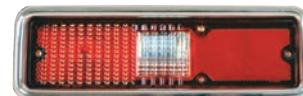

L1622

CTL6264LED

1962-64 LED Tail Lamp Assembly



M1649D

1970-74 Rear Side Marker Lens Assembly

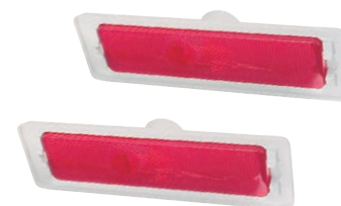

M1649C

1970-74 Front Side Marker Lens Assembly



Exterior Electrical

K70
1968 Front Side Marker, Clear, Also Fits Camaro



K71
1968-69 Rear Side Marker, Red Also Fits Camaro



K72
1968-69 Side Marker Bezel, Also Fits Camaro



M1649A
1970-74 Front Side Marker Lamp Bezel



M1649B
1970-79 Rear Side Marker Lamp Bezel



1702W
1962-66 Telescoping Antenna (No Cable)

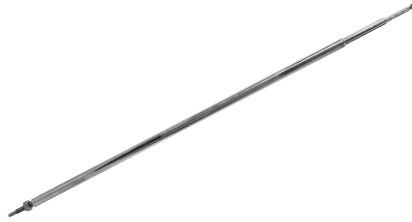

1000C
1967-69 Antenna (No Cable)

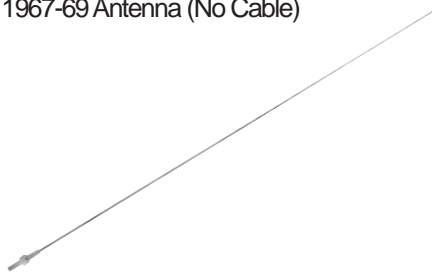

CBL6264LED
1962-64 LED Back Up Lamp Assembly



CBL6667LED
1966-67 LED Back Up Lamp Assembly



M1618
1966-72 License Plate Lamp



Heating Components

1041K
1968-79 Heater Box w/o A/C, Small Block



1041L
1968-70 Heater Box, Big Block



1041R
1968-72 Heater Case (Core Section) w/o A/C



1041W
1964-74 Heater Blower Motor w/o A/C

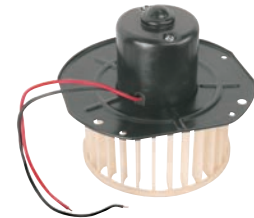

1041X
1970-72 Heater Blower Motor Resistor w/ AC



Glass

1643F

1962-67 Windshield Glass, Clear w/ Blue Top Shade



1643FA

1962-67 Windshield Glass, Green Tinted



1643G

1968-72 Windshield Glass, Clear



1619W

1966-67 Quarter Glass, RH=LH, Clear



1619X

1968-72 Quarter Glass, RH, Clear

1619Y

1968-72 Quarter Glass, LH, Clear



1619N

1968-72 Vent Window Glass, RH, Clear

1619NA

1968-72 Vent Window Glass, LH, Clear



1619T

1966-67 Door Glass, RH=LH, Clear

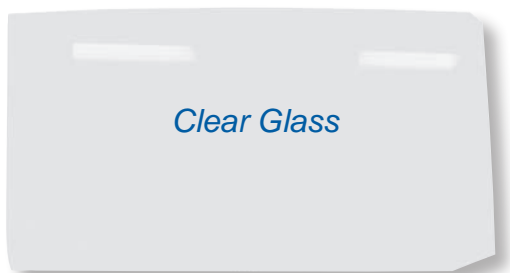

1619U

1968-72 Door Glass, RH, Clear

1619V

1968-72 Door Glass, LH, Clear

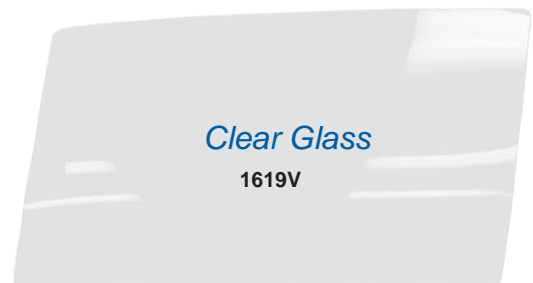

Glass continued on next page

NOVA

Glass

1619R

1966-67 Door Glass Assembly, RH, Coupe

1619S

1966-67 Door Glass Assembly, LH, Coupe

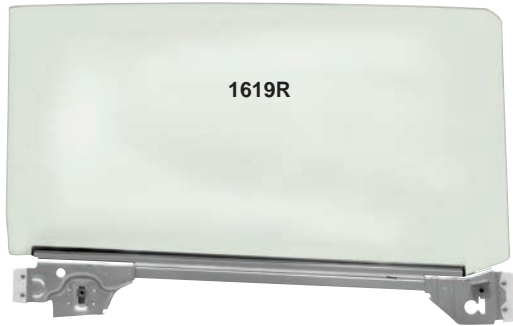

1643H

1968-72 Rear Window Glass, Clear



1619RA

1966-67 Door Glass Frame, w/o Glass, RH

1619SA

1966-67 Door Glass Frame, w/o Glass, LH

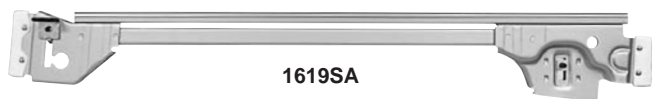

Pedal & Shifter Components

M1726N

1962-67 Brake Pedal Pad (w/o Power Brakes)



M1726P

1962-67 Brake Pedal Pad (Power Brakes)



3935721

1968-79 Disc Brake Pedal Pad, 4-speed Transmission



K981

1968-77 Clutch Pedal Pad

K911

1968-79 Clutch Pedal Pad Trim



Pedal & Shifter Components

K982

1968-77 Drum Brake Pedal Pad, Automatic Transmission

K920

1968-77 Drum Brake Pedal Trim, Automatic Transmission



1006PC *NEW*

1968 Brake & Clutch Pedal Pivot

Reverse View



3893181

1968 Parking Brake Pad

3893182

1968 Parking Brake Pad Trim



PYE12 *NEW*

1968-72 Gas Pedal Support



3945593

1969-74 Parking Brake Pad

3954594

1969-74 Parking Brake Pad Trim



K919

1968-79 Accelerator Pedal Pad

K912

1968-79 Accelerator Pedal Pad Trim

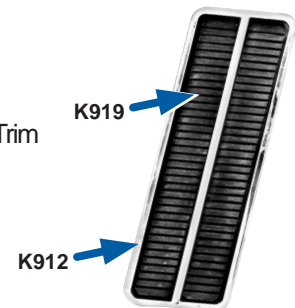

M1619

1962-67 Parking Brake Release Handle



3893179

1968-79 Parking Brake Release Handle



1650

1968-72 Shifter Assembly, 4-Speed
w/o Console Bench Seat



Steering Wheels & Components

9745764

1967 Steering Wheel for "SS", Deluxe



SW12

1969-70 Steering Wheel, Three Spoke Comfort Grip



9747536

1968 Steering Wheel for "SS", Deluxe



9746195

1969-70 Steering Wheel, Walnut



3939731

1969-70 Steering Wheel, Black



3960722

1969-70 Steering Wheel, Rosewood



Steering Wheels & Components

K213

1969-70 Horn Buttons

**K292**

1969-70 Horn Contacts

**M1336**1968 Steering Wheel Hub, 3 15/16" diameter x 1 7/8" Tall
(Also Fits Comfort Grip Wheel SW12)**M1337**1969-70 Steering Wheel Hub, 4 1/8" Diameter x 1 3/16" Tall
(Also Fits Comfort Grip Wheel SW12)

Interior Mirrors & Sun Visor Supports

M1035C

1962-67 Rear View Mirror, Standard

**911366**

1968-72 Rear View Mirror, 10 In.

**916177**

1962-68 Rear View Mirror, 8 In.

**1154F**

1973-81 Rear View Mirror, Day/Night, 10 In.



NOVA

Door Trims & Arm Rests

M1035D

1962-65 Rear View Mirror Bracket



8752692

1968-72 Rear View Mirror Bracket



Reverse View



M1338

1965-73 Sun Visor Support Bracket



Now includes bushing and screws!

M1770

1962-66 Door Lock Knobs, Black, Pair



M1771

1962-66 Door Lock Knobs, Chrome, Pair



M1772

1967 Door Lock Knobs, Black, Pair



M1773

1967 Door Lock Knobs, Chrome, Pair



M1777

1968 Door Lock Knobs, Grooved Black, Pair



M1774

1969-70 Door Lock Knobs, Grooved Chrome, Pair



M1775

1970-76 Door Lock Knobs, Chrome, Pair



M1607

1962-67 Door Inner Molding, RH

M1607A

1962-67 Door Inner Molding, LH



M1040L

1962-64 Arm Rest Bases, Rear, (Also Fits '64-'67 Nova Wagon)



Door Trims & Arm Rests

M1602

1962-64 Arm Rest Bases, Front, Chrome



M1603

1966-67 Arm Rest Bases, Front, Chrome



M1040

1968-72 Arm Rest Base, Black RH

M1040A

1968-72 Arm Rest Base, Black LH

M1040A



M1040B

1968-72 Arm Rest Bases, Red



M1040C

1968-72 Arm Rest Bases, Medium Blue



M1040D

1968-72 Arm Rest Bases, Ivy Gold



M1040E

1968-72 Arm Rest Bases, White



M1040F

1968-72 Arm Rest Bases, Dark Blue



M1040G

1968-72 Arm Rest Bases, Dark Green



Door Sill Scuff Plates

M1620

1962-67 Door Sill Scuff Plate, RH

M1621

1962-67 Door Sill Scuff Plate, LH



M1620

M1622

1968-79 Door Sill Scuff Plate, RH

M1623

1968-79 Door Sill Scuff Plate, LH



M1623

Seats & Components

1776

1962-65 Seat Bottom Spring, RH=LH



1402K

1969-72 Front Seat Bottom Spring, RH=LH

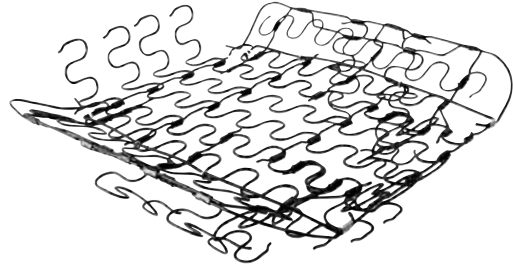

1777

1962-65 Seat Back Spring, RH=LH

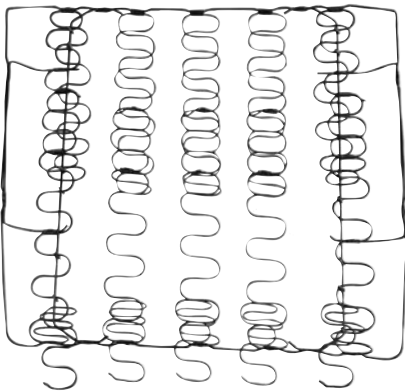

1402P

1969-72 Seat Side Support Spring, 4 Pc.+8 Clip

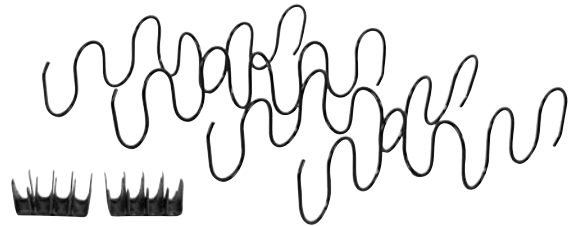

1402L

1968-72 Front Seat Back Spring, RH=LH

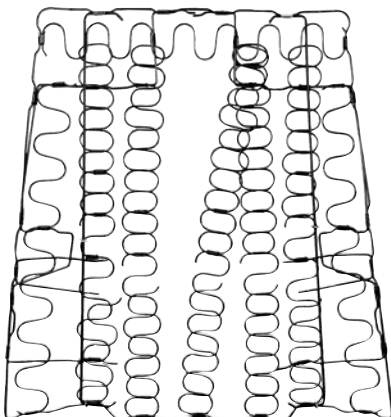

1402A

1969-71 Seat Frame Assembly

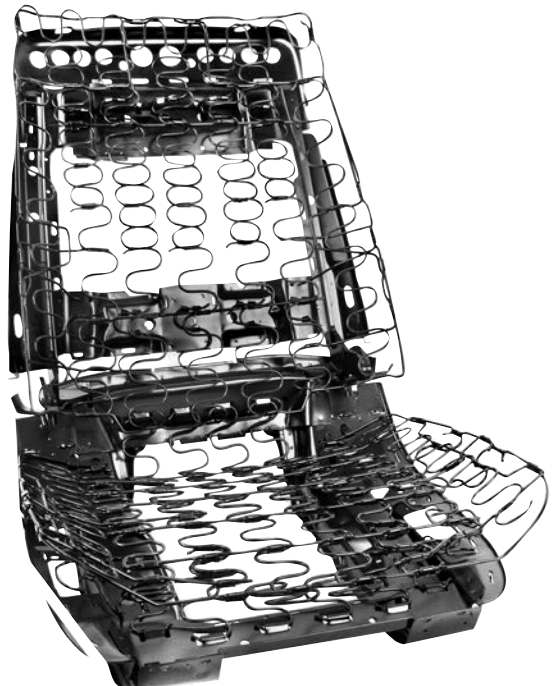

Seats & Components

1636C

1966-67 Seat Frame Supports, 4 Pcs.

**1632JB**

1965 Bucket Seat Track Assembly, RH

1632JC

1965 Bucket Seat Track Assembly, LH

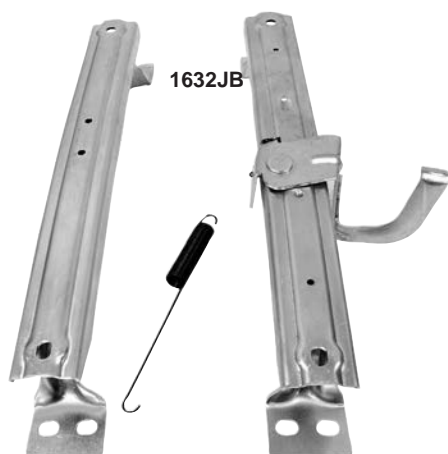
**K883G**

1968-72 Seat Belt Buckle Cover, w/ "GM" Insert

**K75**

1968-72 Seat Back Locking Knob, Chrome

**K15**

1967-72 Seat Track Adjusting Knob, Chrome

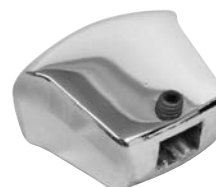
**1636F**

1966-67 Seat Track Adjusting Knob



NOVA

Seat Belts



**Seat Belts with Push Button:
6 colors to choose from**



60 Inch Belts

SB-N2PB	Seat Belt with Push Button	Black
SB-N2PG	Seat Belt with Push Button	Grey
SB-N2PT	Seat Belt with Push Button	Tan
SB-N2PN	Seat Belt with Push Button	Navy Blue
SB-N2PR	Seat Belt with Push Button	Red
SB-N2PM	Seat Belt with Push Button	Maroon



Retractable with 12 " Sleeve & 7" Boot

SB-R2PB	Seat Belt with Push Button	Black
SB-R2PG	Seat Belt with Push Button	Grey
SB-R2PT	Seat Belt with Push Button	Tan
SB-R2PN	Seat Belt with Push Button	Navy Blue
SB-R2PR	Seat Belt with Push Button	Red
SB-R2PM	Seat Belt with Push Button	Maroon



SB-90BR

SB-20FLP	20" Webbing Chrome Push Buckle Black. (Chevy Pu Bench Seat)	Black
SB-90BR	90 Degree End Bracket	



**Seat Belts with Lift Latch:
10 colors to choose from**

60 Inch Belts

SB-N2LB	Seat Belt with Lift Latch	Black
SB-N2LG	Seat Belt with Lift Latch	Grey
SB-N2LM	Seat Belt with Lift Latch	Maroon
SB-N2LN	Seat Belt with Lift Latch	Navy Blue
SB-N2LR	Seat Belt with Lift Latch	Red
SB-N2LT	Seat Belt with Lift Latch	Tan

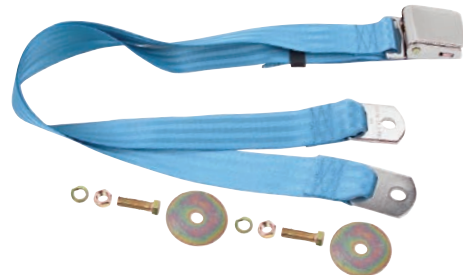

Retractable with 12 " Sleeve & 7" Boot

SB-R2LB	Seat Belt with Lift Latch	Black
SB-R2LG	Seat Belt with Lift Latch	Grey
SB-R2LM	Seat Belt with Lift Latch	Maroon
SB-R2LN	Seat Belt with Lift Latch	Navy Blue
SB-R2LR	Seat Belt with Lift Latch	Red
SB-R2LT	Seat Belt with Lift Latch	Tan

3 Points Retractable Shoulder Belt



SB-R3LB	Retractable 3 Point Seat Belt with Chrome Latch	Black
SB-R3PB	Retractable 3 Point Seat Belt with Push Button	Black
SB-R3PG	Retractable 3 Point Seat Belt with Push Button	Grey
SB-R3PT	Retractable 3 Point Seat Belt with Push Button	Tan
SB-R3PN	Retractable 3 Point Seat Belt with Push Button	Navy Blue
SB-R3PR	Retractable 3 Point Seat Belt with Push Button	Red

Clothes/Harness Hooks

GM01

1968-72 Clothes Hanger Hooks



GM02

1968-72 Shoulder Harness Hooks

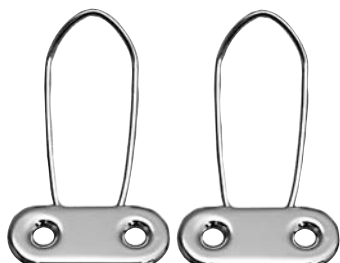

Quarter Inner Trim

1621XC

1962-65 Quarter Inner Trim, RH

1621XD

1962-65 Quarter Inner Trim, LH



1621XC

1621XA

1966-67 Quarter Inner Trim, RH

1621XB

1966-67 Quarter Inner Trim, LH



1621XA

Magnum Alloy Wheels

CAPS or CAPT

Magnum Alloy Wheel Cap w/ Decal, Short Style or Tall Style
(Fits FW & GW Series Wheels)



GW157P NEW

Magnum Alloy Wheel 15"x7" New Design w/ Center Cap,
4" Backspace *Improved Tooling & Finish*

4.3/4" Bolt Pattern

Tall-Style
Wheel Cap
included with
all 15" Rims



GW158P NEW

Magnum Alloy Wheel 15"x8" New Design w/ Cap,
4." Backspace

4.3/4" Bolt Pattern

Tall-Style
Wheel Cap
included with
all 15" Rims



Interior Electrical

GME41 *NEW*

1962-79 Oil Sending Unit



LH47

1967-68 Windshield Wiper Switch, 2-Speed



LH40

1962-64 Windshield Wiper Switch, Single Speed w/ Washer



LH52

1969-71 Windshield Wiper Switch



LH41

1963-64 Windshield Wiper Switch, 2-Speed w/ Washer



Interior Electrical

1010H

1964-72 Horn, High

1010L

1964-72 Horn, Low



1010H

1010U

1962-79 Horn Set w/ Universal Brackets, 6 Pcs.

**1010HC**

1964-72 Horn High + Low Note Chrome Plate w/ Mounting Bracket and Hardware

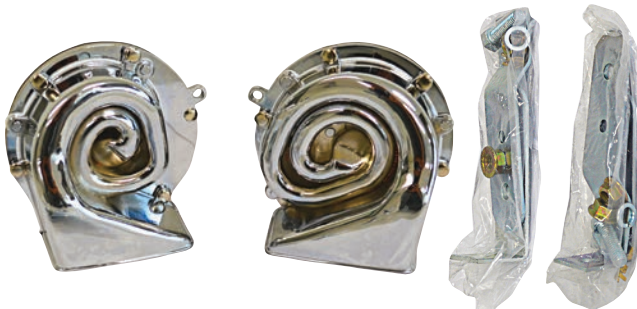
**7031884**

1967-68 Cigarette Lighter

**GFI085 NEW**

1969-79 Ignition Switch w/o Tilt

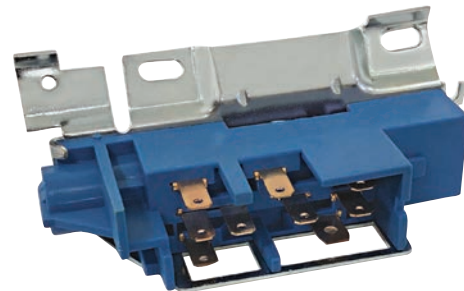
**GFI086 NEW**

1969-79 Ignition Switch w/ Tilt

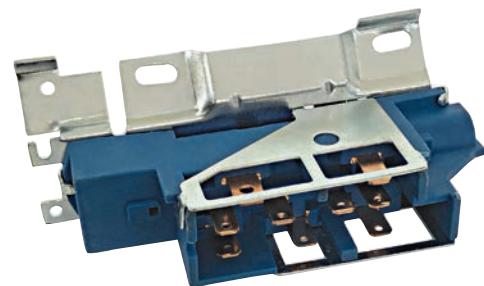

NOVA

Interior Electrical

M1013C
1962-63 Headlamp Switch



M1013B
1974-79 Headlamp Switch

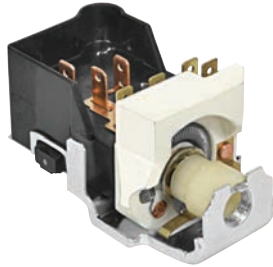

8732777
1971-79 Dome Light Lens
20030351
1971-79 Dome Light Base

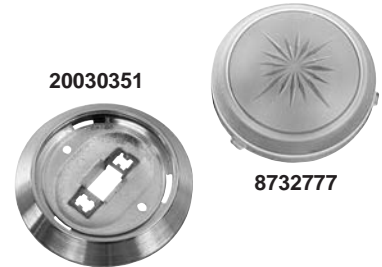

M1013
1964-73 Headlamp Switch

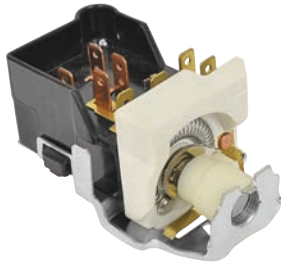

LH01
1964-72 Headlamp Dimmer Switch



Brake Backing Plates

1006G
1969-74 Front Disc Brake Backing Plate



LH01C NEW
1974-79 Headlamp Switch
w/o Parking Light

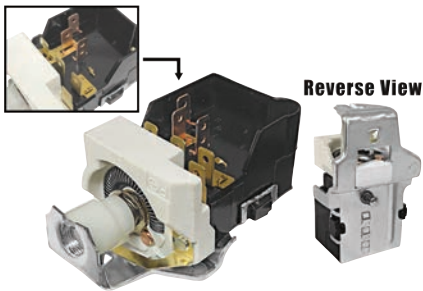

4866918
1962-69 Dome Light Base,
Nova / Chevy II

K35
1962-69 Dome Light Lens



1006H
1975-79 Front Disc Brake Backing Plate



Door Sill Decal

FL01

1962-74 "Body by Fisher" Decal



Body Bushing Kit

M1609

1968-74 Body Bushing Kit



Ignition, Door & Trunk

266

1962-64 Original



267

1965 Original

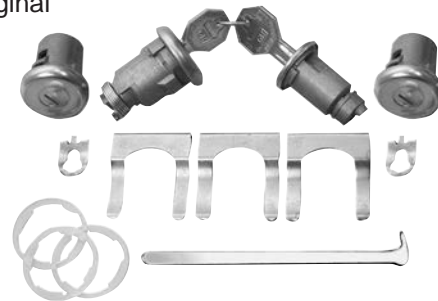

268

1966-67 Original

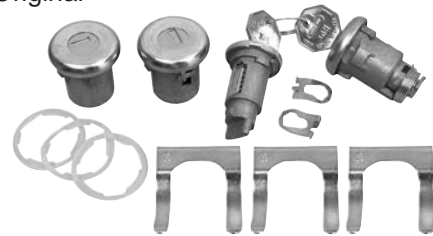

Ignition & Door Lock Kits

142

1962-64 Rectangular



NOVA

Ignition & Door Lock Kits

142A
1962-64 Octagonal

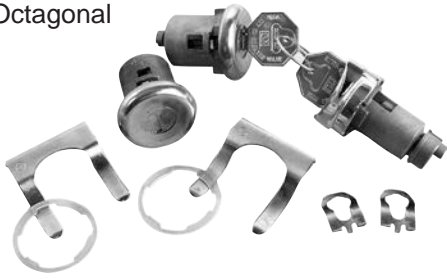

105
1968 Later



143A
1965 Original

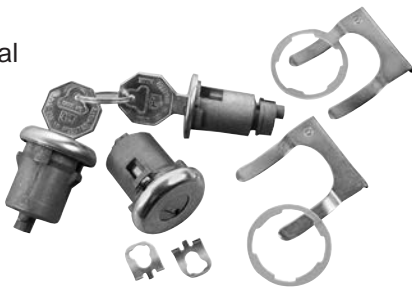

105A
1968 Original



104
1966-67 Later



106
1969-78 Later

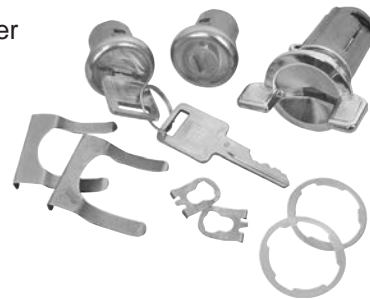

104A
1966-67 Original



Ign., Door, Glove, Trunk

295
1962-64 Original

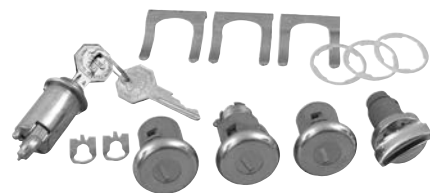

Ign.,Door,Glove,Trunk

296
1965 Original



288
1966-67 Original

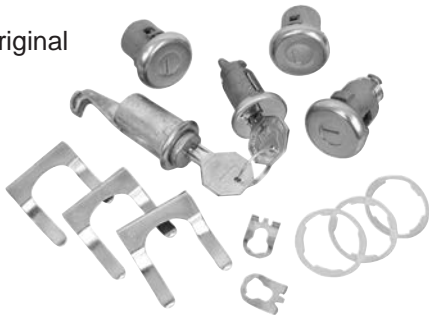

336
1968 Original

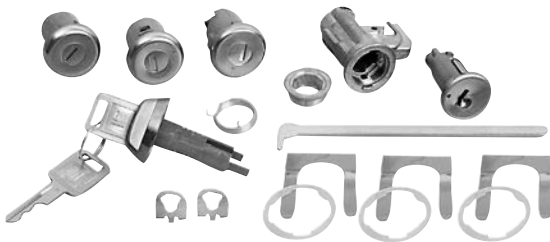

337
1969-78 Original

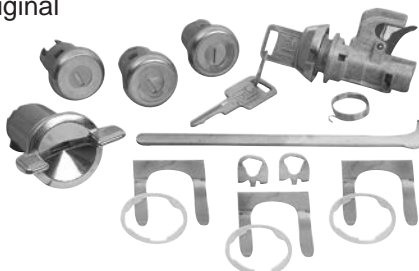

Glove Box Locks

163
1962-65 Later



163A
1962-65 Original

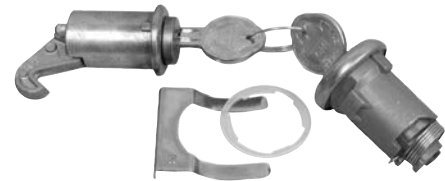

118
1966-67 Later

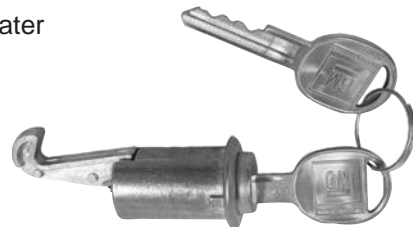

118A
1966-67 Original

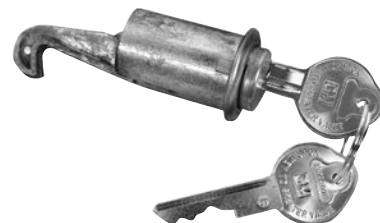

NOVA

Glove Box Locks

119
1968-79 Later



119A
1968 Original

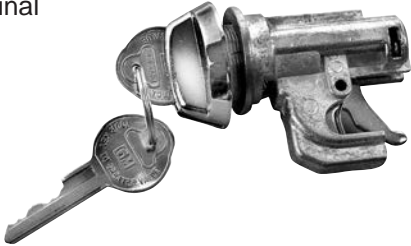

158
1965 Octagonal



158A
1965 Original



Ignition Locks

157
1962-64 Octagonal



161
1962-64 Original



100
1966-67 Later



100A
1966-67 Original



Ignition Locks

101
1968 Later



101A
1968 Original

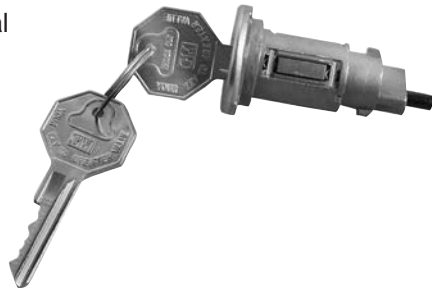

102
1969-78 Later



1575
1962-79 Later

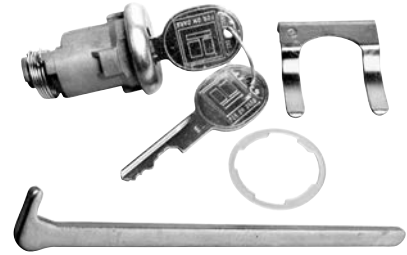

112A
1962-67, 69-79 Original



112B
1968 Original

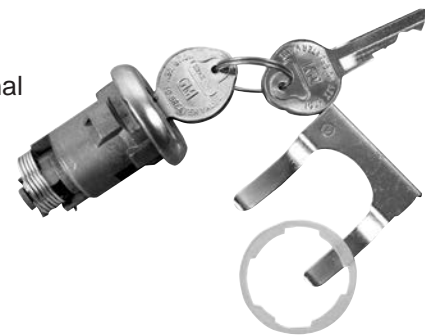

Trunk Locks & Kit

112
1962-79 Later



Glove Box & Trunk Kits

164
1962-65 Later

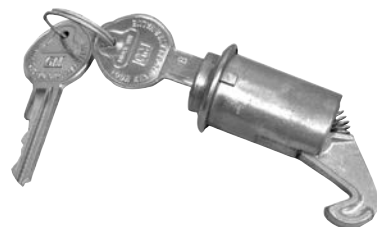

NOVA

Glove Box & Trunk Kits

164A
1962-65 Original



150
1968-79 Later



121
1966-67 Later

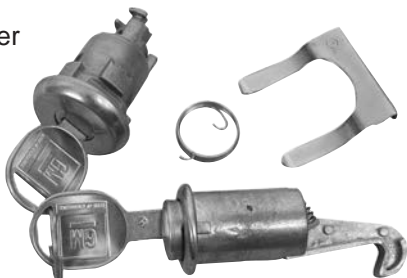

CL-955
1962-72 Key-less, Original



121A
1966-67 Original

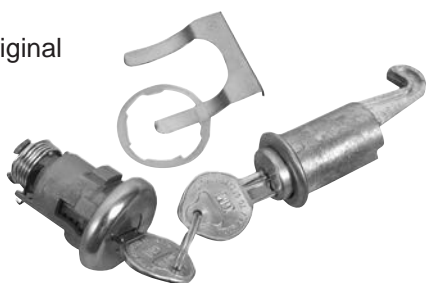

CL-960
1962-72 Key-less
(Non-Original, Brushed Stainless)



150A
1968 Original

