

*Golden Leaf  
Automotive*

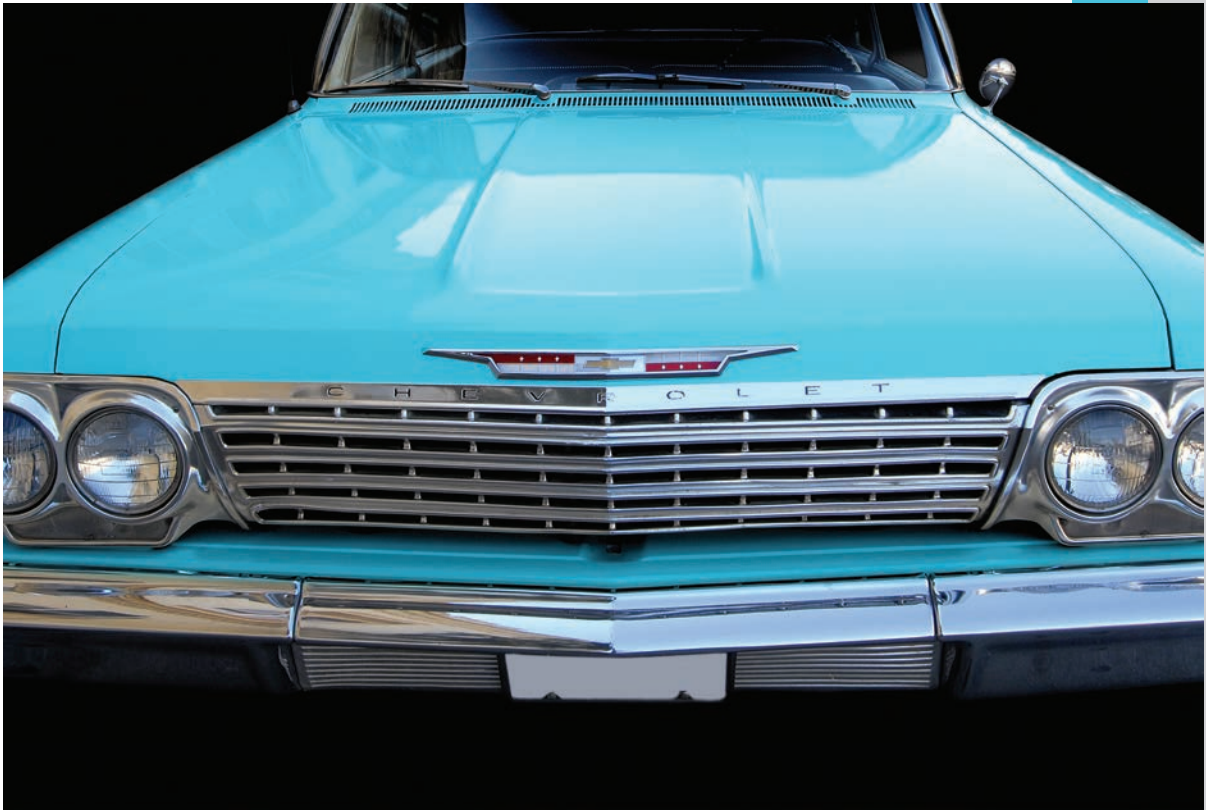

**2023  
IMPALA**

# Impala Index

## A

Accelerator Pedal Pad: 55  
Accelerator Pedal Pad Trim: 55  
A/C Vent Ball: 14  
Antennas & Cables: 49  
Arm Rest Bases: 58  
Arm Rest Pad: 58

## B

Back Up Lamps & Lenses: 50  
Battery Clamp Bolts: 7  
Battery Monitor: 64  
Battery Tray: 6  
Battery Tray Clamp: 7  
Billet Hood Hinge: 11, 12  
Body Bushing Kits: 65  
Body Panels, Rear: 29  
Body Shims & Washers: 8  
Body Side Molding: 42, 43  
Body Side Molding Clips: 43  
Brake Pedal Pad: 55  
Brake Pedal Pad Trim: 55  
Bucket Seat Molding Set: 60  
Bucket Seat Mounting Bracket: 16  
Bumper Arms: 3  
Bumper Center Brace: 3  
Bumper Fillers: 4  
Bumper Reinforcement: 2  
Bumpers & Guards: 1, 2  
Bumper Brackets: 2, 3

## C

Carpet Guard: 59  
Cigarette Lighter: 63  
Clutch Countershaft (Z-bar): 55  
“C” Moldings, Rear: 43  
Console Mounted Clock: 13  
Control Arm: 7, 8  
Control Arm Bumper: 8  
Cornering Lamp Bezels: 53  
Cornering Lamp Lenses: 53  
Cove Moldings: 45  
Cowl Panels: 13  
Cowl Vent Grille: 37  
Crossmember Transmission Support: 16

## D

Dash Components: 13, 14  
Dashes & Glove box: 13, 14  
Dash Panel: 13  
Decal: 65  
Deck Lid Filler Panel: 29  
Disc Brake Pedal Pad: 55  
Disc Brake Pedal Pad Trim: 55  
Dome Light Base: 64  
Dome Light Lens: 63, 64

Door Accessories: 24, 25, 26, 27  
Door Catch: 24  
Door Glass Assembly: 53  
Door Glass & Lower Window Frame: 54  
Door Handle Push Button Kit: 24  
Door Handles: 24, 25  
Door Hinge: 24  
Door Latch: 24  
Door Lock Knobs: 58  
Door Lock Striker: 24  
Door Molding: 40  
Doors & Hardware: 23, 24  
Door Shell: 23  
Doors & Hinges: 23, 24  
Door Glass & Lower Window Frame: 53  
Door Sill Scuff Plates: 58  
Door Trims & Arms Rests: 58  
Door Window Lower Frame: 54  
Drip Rail Molding: 40  
Drip Rails, Roof: 22

## E

Electrical, Interior: 63, 64  
Emblems: 46, 47, 48, 49  
Engine Compartment: 5, 6, 7  
Engine Mounts: 5  
Exterior Electrical & Components: 49, 50, 51, 52, 53  
Eyebrow Moldings: 35

## F

Fender Brace Skirt: 9  
Fender Extension Moldings: 38  
Fenders, Inner, Front: 9, 10  
Firewall Carpet Guard: 59  
Floor Pan Braces & Supports: 16  
Floor Pan Plug: 16  
Floor Pans & Components: 14, 15, 16  
Floor-to-Firewall Braces: 16  
Fresh Air Vent Assembly: 54  
Front Fender Extension Moldings: 38  
Front Fender Molding & Ornaments: 38  
Front Fenders & Components: 8, 9  
Fuel Sending Unit Float: 34  
Fuel Sending Unit Gasket: 34  
Fuel Sending Unit Locking Ring: 34  
Fuel Sending Units: 33, 34  
Fuel Tank Brace: 33  
Fuel Tanks: 31, 32  
Fuel Tank Straps: 33

## G

Gas Cap: 32  
Glass & Seals: 53, 54  
Glove Box Door: 13  
Glove Box Door Hinge: 13  
Glove Box Locks: 70, 71

Glove Box & Trunk Lock Kits: 69, 70  
Grille Emblem Bezel: 37  
Grille Molding: 36  
Grille Molding Fasteners: 36  
Grilles & Components: 34, 35, 36, 37  
Grille Support / Bumper Filler: 36

## H

Hazard Switch Knob: 14  
Header Panels: 4  
Headlamp Bezels: 34, 35  
Headlamp Bucket: 35  
Headlamp Dimmer Switch: 63  
Headlamp Mounting Buckets: 35  
Headlamp Retaining Rings: 35  
Headlamp Switch: 63  
Headliner Clips: 22  
Heater Box & Core: 54  
Heating / Cooling Components: 54  
Hood Hinge: 11, 12  
Hood Hinge Spring: 11  
Hood Latch Assembly: 10  
Hoods: 12  
Hoods & Components: 10, 11, 12  
Hood Latch Support: 10, 11  
Hood Spears & Molding: 38  
Horns: 64

## I

Ignition, Door, Glove Box & Trunk Kits: 68, 69  
Ignition & Door Locks: 66, 67  
Ignition Locks: 65, 66  
Ignition Switch: 64

## L

License Panel Clips: 46  
License Panels: 45, 46  
License Plate Bracket: 30  
License Plate Frames: 30  
Locks: 65, 66, 67

## M

Magnum Alloy Wheels: 62  
Mirrors & Brackets, Interior: 58  
Mirrors, Exterior: 39  
Mirrors & Brackets, Interior: 57

## P

Parking Brake Assembly: 54  
Parking Brake Pedal Pad Trim: 55  
Parking Brake Release Handles: 56  
Parking Lamp Gasket: 53  
Parking Lamp Housing: 52  
Parking Lamps & Lenses: 52  
Park Lamp Bezels: 53

Park Lamp Lens: 53  
Pedals (Accelerator, Brake & Clutch): 55  
Pedal & Shifter Components: 54, 55, 56  
Power Door Lock Switch: 64  
Power Window Motor: 23, 63

## Q

Quarter 'B' Pillar Panels: 23  
Quarter Extension Molding: 45  
Quarter Light Assembly: 63  
Quarter Panel: 27  
Quarter Panel Molding: 43, 44  
Quarter Window Stopper: 53

## R

Radiator Grille Supports: 5  
Radiator Support Frame: 5  
Radiator Supports: 4, 5  
Rear Body Panels: 29  
Rear View Mirror Bracket: 58  
Rear View Mirrors: 57, 58  
Rear Window Molding: 43  
Rear Window Moldings Clips: 43  
Rear Wrap-Around Moldings: 44  
Remote Mirror: 39  
Rocker Panel Molding Clips: 42  
Rocker Panels: 22  
Rocker Panel Moldings: 42  
Roof Drip Rails: 22  
Rubber Seals: 53

## S

Scuff Plates: 58  
Seat Back Spring: 60  
Seat Belts: 61  
Seat Bottom Spring: 60  
Seat Frame Assembly: 59  
Seat Molding: 60  
Seat Mounting Brackets: 16  
Seats & Components: 59, 60  
Seat Side Support Spring: 59  
Seat Track: 59  
Shifter Lever: 56  
Speedometer Cable Grommet: 14  
Standard Rear Panel Molding: 45  
Steering Column Seals: 57  
Steering Wheels & Components: 56, 57  
Sun Visor Brackets: 57  
Suspension: 7, 8

## T

Tail / Back Up Lamp Bezel: 52

Tail / Back Up Lamp Lens Trim: 51  
Tail Lamp Bezel: 52  
Tail Lamp Cove Moldings: 44  
Tail Lamp Housing: 51  
Tail Lamps & Lenses: 50, 51  
Tail Lamp Surround: 52  
Tail Light Mounting Panels: 30  
Tail Panel Brace: 31  
Tank Bracing: 33  
Temperature Sending Switch: 64  
Trailing Arm Bushings: 8  
Transmission Indicator Bezels: 57  
Transmission Indicator Lens: 57  
Trunk Catch Lock Striker: 30  
Trunk Cross Rail Panel: 19  
Trunk Divider Panel: 20, 21  
Trunk Floor Braces: 22  
Trunk Floor Drop Offs: 20  
Trunk Floor Pans & Components: 17, 18, 19, 20, 21  
Trunk Latch: 30  
Trunk Lid Hinges: 30  
Trunk Lid Molding: 45  
Trunk Lids & Components: 29, 30  
Trunk Locks: 67  
Trunk Molding: 44, 45  
Trunk Rear Body Panel: 19  
Trunk Rear Cross Rail: 19  
Trunk Rear Cross Rail Brace: 19  
Trunk Shelf Panel: 18  
Trunk Spear: 45  
Trunk Weatherstrip Channel: 30

## U

U-Jamb Rubber Seals: 53

## V

Vent Window Actuator: 27  
Vent Window Bumpers: 53  
Vent Window Seals: 53

## W

Wheelhouse Brace: 28  
Wheelhouses & Components: 27, 28  
Wheel Opening Moldings: 40, 41  
Window Crank: 26  
Window Molding, Rear: 43  
Window Regulators: 23  
Windshield Moldings: 40  
Windshield Washer Bottle Bracket: 7  
Windshield Wiper Switch: 63  
Wiper Blades & Arms: 37



General Motors Trademarks  
are used under License to  
Dynacorn International Inc.

# IMPALA

## Bumpers & Guards

**1705K**  
1962 Front Bumper, 3 Pcs.



**1705B**  
1963 Front Bumper, 3 Pcs.



**1705A**  
1964 Front Bumper, 3 Pcs.

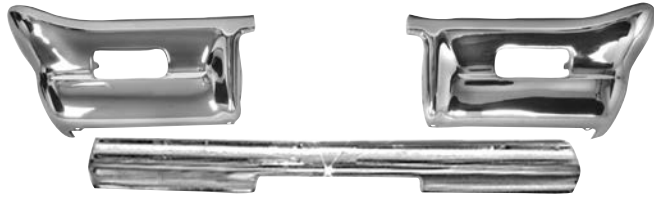

**1705M**  
1965 Front Bumper, 3 Pcs.



**1705G**  
1966 Front Bumper, 3 Pcs.



**1700W**  
1966 Front Lower Bumper, Painted



**1700X**  
1966 Front Lower Bumper, Chrome



**1705J**  
1966 Rear Bumper, 3 Pcs.



**1705**  
1964 Rear Bumper, 3 Pcs.



**1705L**  
1962 Rear Bumper, 3 Pcs.





## Bumpers & Guards

**1705C**  
1963 Rear Bumper, 3 Pcs.



**1705E**  
1965 Rear Bumper, 3 Pcs.



**1705Q**  
1962 Rear Bumper Guards, Chrome



**1705R**  
1968 Rear Bumper Guards  
(Excludes Wagon) Also Fits Caprice

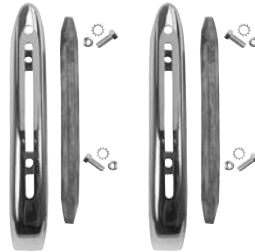

**1705GA**  
1966 Front Bumper Guards

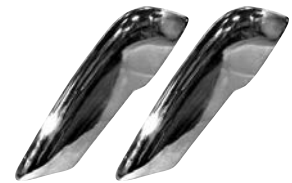

**1705GB**  
1961 Rear Bumper Guards



**1705N**  
1964 Front Bumper Guards, Pair



**1705P**  
1968 Front Bumper Guards



## Bumper Reinforcement Bar

**1700R**  
1964 Front Bumper Center Reinforcement Bar



(1700R detail)

## Bumper Brackets

**1700K**  
1963-64 Front Bumper Bracket, RH

**1700L**  
1963-64 Front Bumper Bracket, LH



1700K

*Bumper Brackets  
continued on next page*

# IMPALA

## Bumper Brackets

### 1700T

1963 Front Bumper Brackets, 5 Pcs.



### 1700U

1963 Rear Bumper Brackets, 4 Pcs.



### 1700S

1964 Front Bumper Center Brace



### 1700M

1964 Front Bumper Brackets, RH, 3 Pcs.

### 1700N

1964 Front Bumper Brackets, LH, 3 Pcs.



1700M

### 1700P

1964 Rear Bumper Brackets, RH, 2 Pcs.

### 1700Q

1964 Rear Bumper Brackets, LH, 2 Pcs.



1700P

### 1707A

1966 Front Bumper Arms, 4 Pcs.



## Bumper Fillers

**1700CA**  
1962 Front Bumper Filler



**1700**  
1963 Front Bumper Filler



**1700C**  
1964 Front Bumper Filler



## Header Panel

**1739A**  
1965 Header Panel



**1739**  
1966 Header Panel



## Radiator Supports

**1700ID**  
1962 Radiator Support



**1700I**  
1963 Radiator Support



**1700J**  
1964 Radiator Support



**1700JC**  
1965 Radiator Support



*Radiator Support  
continued on next page*

# IMPALA

## Radiator Supports

**1700JE**  
1966 Radiator Support



**1700IB**  
1962 Upper Radiator Support



**1700IA**  
1963 Upper Radiator Support



**1700JB**  
1964 Upper Radiator Support, Black



**1700IC**  
1962 Radiator Grille Supports, 3 Pcs.



**1700JA**  
1965-66 Radiator Support Frame, Black, for Small Block

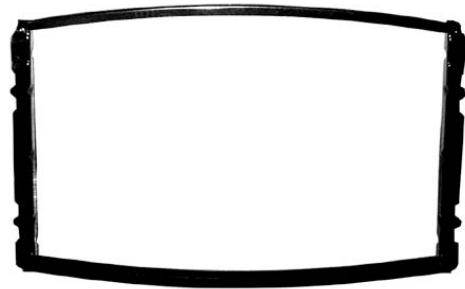

## Engine Compartment

**1726**  
1958-64 Engine Mounts for V8



**1727**  
1963-64 Engine Mounts for 6 Cylinder



## Engine Compartment

**M1721E**  
1958 Battery Tray



**M1721A**  
1965 Battery Tray



**M1721F**  
1959-61 Battery Tray



**1488M**  
1966 Battery Tray



**M1720**  
1962-63 Battery Tray



**1488J**  
1967 Battery Tray



**M1721**  
1964 Battery Tray



**1488K**  
1968 Battery Tray





# IMPALA

## Engine Compartment

**M1721J**  
1958 Battery Tray Clamp



**M1721K**  
1958 Battery Clamp Bolts

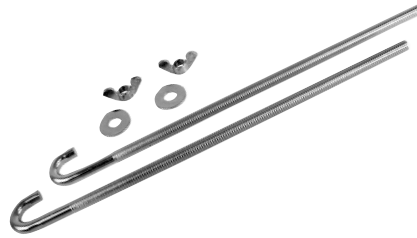

**1425**  
1962-70 Windshield Washer Bottle Bracket



**M1722**  
1962-63 Battery Tray Clamp



**M1723**  
1964-65 Battery Tray Clamp

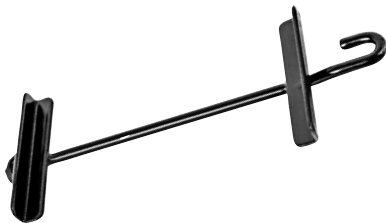

**1047E**  
1966-76 Battery Tray Clamp



**1047EC**  
1966-76 Battery Tray Clamp, Stainless



## Suspension

**1708B**  
1958-64 Control Arm Upper, Pair (Tubular)



Reverse View

**1708C**  
1958-64 Control Arm Lower, Pair (Tubular)



Reverse View

**1708D**  
1965-70 Control Arm Upper, Pair (Tubular)



Reverse View

## Suspension

### 1708E

1965-70 Control Arm Lower, Pair (Tubular)



### 1007

1958-70 Control Arm Bumper



### M1726L

1959-64, 1965-70 Trail Arm Bushings,  
Upper Front & Rear / Lower Rear  
Lower Front w/ Large Diameter Bushings



### M1726M

1959-64 Trail Arm Bushings, Lower Front



## Body Shims

### 1000F

1961-72 Body Shims, 6 mm, 10 Pc., Set



### 1000E

1964-72 Body Shims, 1.6 mm, 10 Pc., Set

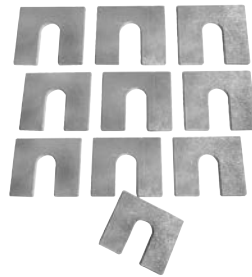

### 1000D

1964-72 Body Shims, 3 mm, 10 Pc., Set

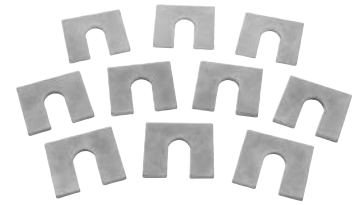

### GM03

1960-72 Body Washers, 20 Pc., Set



## Front Fenders & Components

### 1702Y

1962 Front Fender, RH

### 1702Z

1962 Front Fender, LH



### 1703

1963 Front Fender, RH

### 1704

1963 Front Fender, LH



*Fenders continued on next page*

# IMPALA

## Front Fenders & Components

**1703A**  
1964 Front Fender, RH

**1704A**  
1964 Front Fender, LH

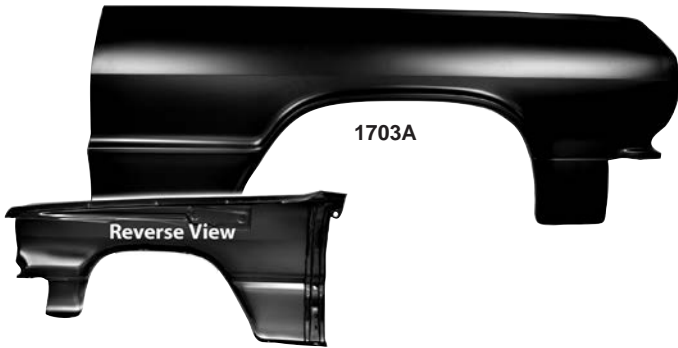

**1704D**  
1965 Front Fender, RH

**1704E**  
1965 Front Fender, LH



**1704F** *COMING SOON!*

1966 Front Fender, RH

**1704G** *COMING SOON!*

1966 Front Fender, LH



**1702R**  
1962 Fender Brace Skirt, RH

**1702S**  
1962 Fender Brace Skirt, LH



## Front Inner Fenders

**1719Y**  
1962 Inner Fender, RH

**1719Z**  
1962 Inner Fender, LH



**1720**  
1963 Inner Fender, RH

**1721**  
1963 Inner Fender, LH



## Front Inner Fenders

**1700D**  
1964 Inner Fender, RH  
**1700E**  
1964 Inner Fender, LH



**1722**  
1965 Inner Fender, RH  
**1723**  
1965 Inner Fender, LH



**1724**  
1966 Inner Fender, RH  
**1725**  
1966 Inner Fender, LH



## Hoods & Components

**1702M**  
1962 Hood Latch Assembly



**1702E**  
1963 Hood Latch Assembly



**1702F**  
1964 Hood Latch Assembly



**1702FA**  
1966 Hood Latch Assembly

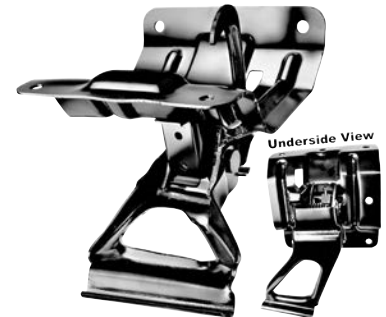

**1702N**  
1962 Hood Latch Support



**1702K**  
1965 Hood Latch Support



*Hood Latch Support  
continued on next page*

# IMPALA

## Hoods & Components

**1702L**  
1966 Hood Latch Support



**1701A**  
1963-64 Hood Hinge, RH

**1701B**  
1963-64 Hood Hinge, LH



**1464Y**  
1968 Hood Hinge, RH

**1464Z**  
1968 Hood Hinge, LH



**1701C**  
1962 Hood Hinge, RH

**1701D**  
1962 Hood Hinge, LH

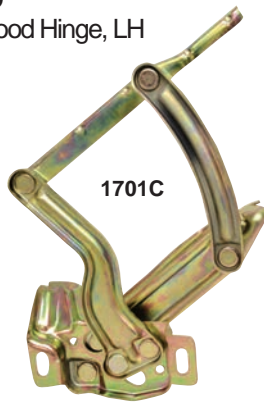

**1068G**  
1965-67 Hood Hinge, RH

**1068H**  
1965-67 Hood Hinge, LH



**1466**  
1970 Hood Hinge, RH

**1467**  
1970 Hood Hinge, LH



**1069AX**  
1967-69 Hood Hinge Spring



**1069AY**  
1970 Hood Hinge Spring



**1069AZ**  
1971-76 Hood Hinge Spring



**BH30**  
1963-64 Billet Hood Hinge, Pair



**BH01**  
1965-67 Billet Hood Hinge, Pair





## Hoods & Components

**BH12**  
1968 Billet Hood Hinge, Pair

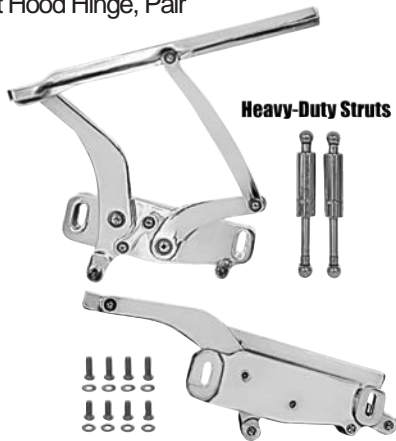

**BH13**  
1970 Billet Hood Hinge, Pair



**1701E**  
1962 Hood



**1701**  
1963 Hood

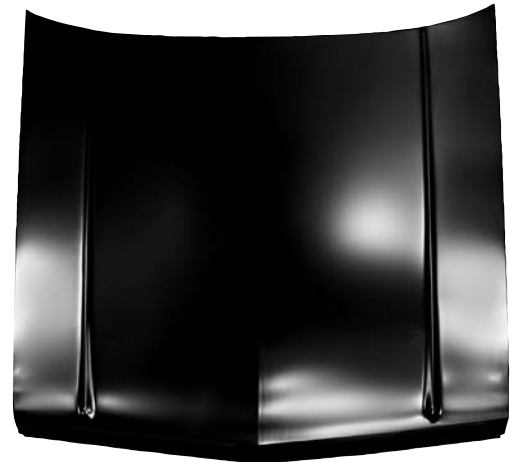

**1702**  
1964 Hood



**1706**  
1965-66 Hood



# IMPALA

## Cowl Panels

**1729**

1961-64 Cowl Panel, Upper



**1785A**

1965-66 Cowl Panel, Upper & Lower



**Underside View**

**1784**

1962-64 Outer Cowl Panel, RH

**1785**

1962-64 Outer Cowl Panel, LH



1784

## Dash Components

**1728**

1963-64 Steel Dash Panel



**1794**

1963-64 Glove Box Door



**1794A**

1963-64 Glove Box Door Hinge



**1709R**

1965 Console Mounted Clock



## Dash Components

**1403C**

1965-76 Speedometer Cable Grommet



**3856472**

1965-68 A/C Vent Ball  
(1967 w/ A/C and all 1968 Astro-Vent)



**M1035L**

1968-70 Hazard Switch Knob Chrome



## Floor Pans & Components

**1700GA**

1961-64 Full Floor Pan, 2 Door Only



**1700GJ**

1962-64 Floor / Rear Seat, Inner Rocker, Braces, Coupe, EDP Coating (1Pc. Floor)

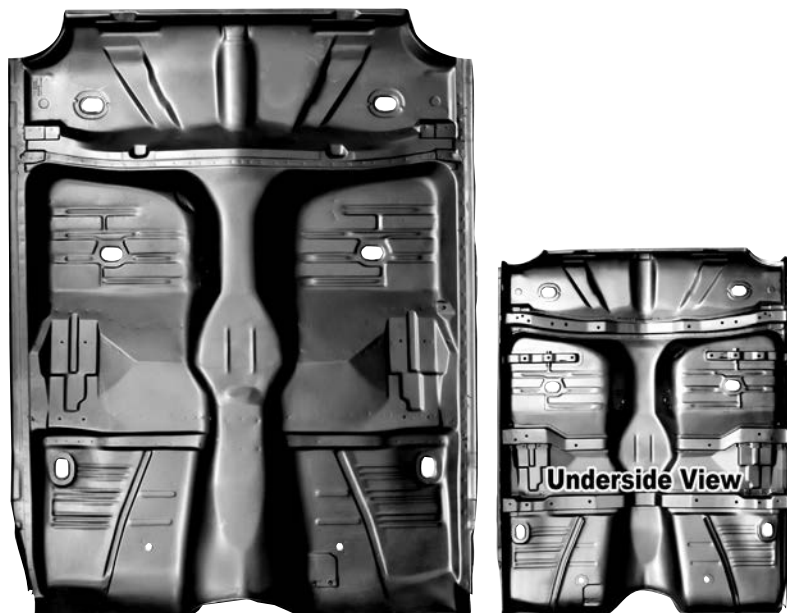

*Floor Pans continued on next page*

# IMPALA

## Floor Pans & Components

### 1783WT

1965-70 Complete Floor Pan w/ Braces, Rocker Panels, R. Seat Pan, Weld-Through Primer

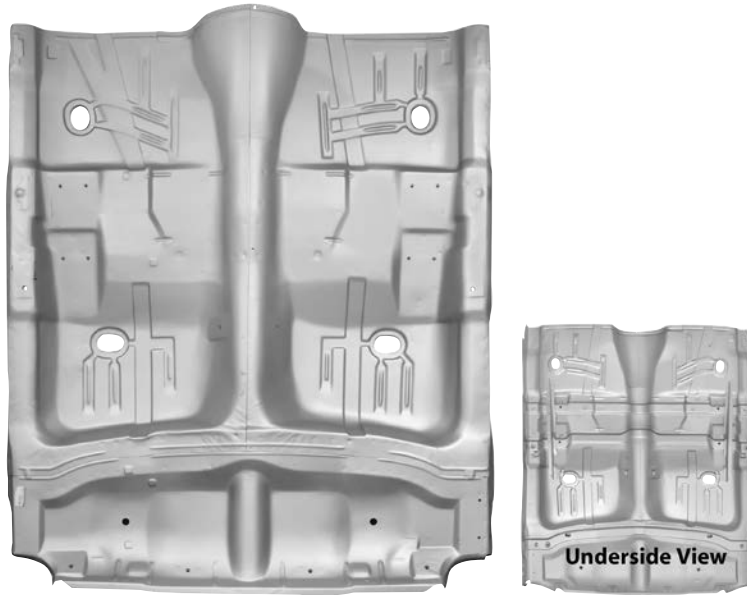

### 1700F

1961-64 Full Floor Pan, RH

### 1700G

1961-64 Full Floor Pan, LH



1700F

### 1783RWT

1965-70 Floor Pan, Weld-Through Primer, RH

### 1783LWT

1965-70 Floor Pan, Weld-Through Primer, LH

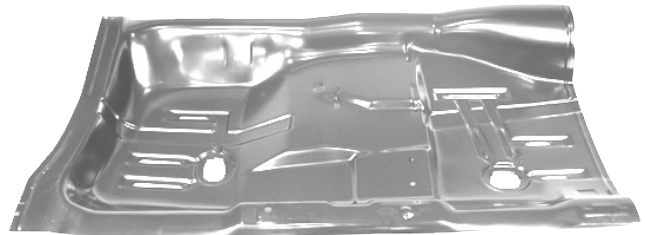

1783RWT

### 1780

1961-64 Rear Seat Floor Pan



### 1781WT

1965-70 Rear Seat Floor Pan, Weld-Through Primer



## Floor Pans & Components

### 1766AWT

1961-64 Front Floor Pan Brace, Weld-Through Primer



### 1766FWT

1961-64 Rear Floor Pan Brace, Weld Through Primer



### 1783AWT

1965-70 Front Floor Pan Under Support, Weld-Through Primer



### 1783BWT

1965-70 Center Floor Pan Under Support, Weld-Through Primer



### 1783CWT

1965-70 Rear Floor Pan Under Support, Weld-Through Primer



### 1783D

1965-70 Floor Side Under Support, RH, Weld Through Primer

### 1783E

1965-70 Floor Side Under Support, LH, Weld Through Primer



### 1766BWT

1961-64 Floor Pan Brace Under Front Seat, RH, Weld Through Primer

### 1766CWT

1961-64 Floor Pan Brace Under Front Seat, LH, Weld Through Primer

1766BWT

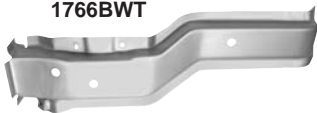

### 1766DWT

1961-64 Floor Pan Brace Under Rear Seat, RH, Weld Through Primer

### 1766EWT

1961-64 Floor Pan Brace Under Rear Seat, LH, Weld Through Primer

1766DWT



### 1700GKWT

1961-64 Bucket Seat Mounting Bracket Set, 4 Pcs., Weld-Through Primer

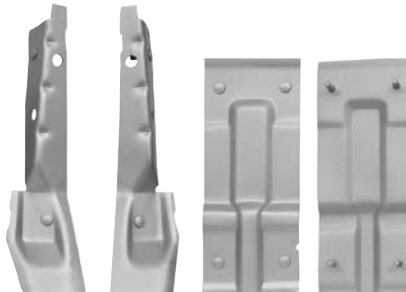

### 1047F

1964-72 Floor Pan Plug



### 1766HWT

1961-64 Floor-to-Firewall Braces, Weld Through Primer



1766HWT

### 1766G

1958-64 Crossmember Transmission Support





# IMPALA

## Trunk Floor Pans & Components

### 1700HDWT

1963 Trunk Floor Pan w/ Shelf Panel / Wheelhouses, Weld-Through Primer



### 1700HGWT

1964 Trunk Floor Pan w/ Shelf Panel / Wheelhouses, Weld-Through Primer

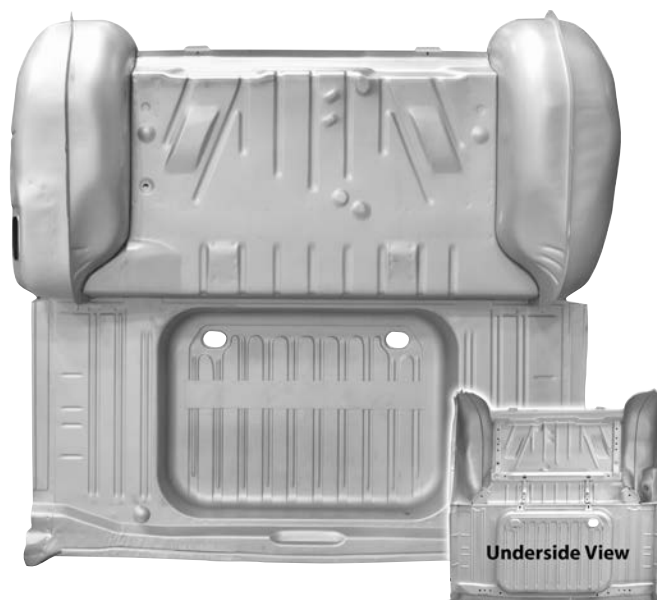

## Trunk Floor Pans & Components

### 1700HKWT

1962 Trunk Floor w/ Pan, Weld Through Primer



### 1700H

1961-64 Trunk Floor Pan, 2/4 Door



### 1700HBWT

1963 Trunk Floor w/ Pan, Weld Through Primer



### 1700HA

1963-64 Trunk Floor Outer Panel



### 1700HCWT

1964 Trunk Floor w/ Pan, Weld Through Primer



### 1781B

1961-64 Trunk Shelf Panel



# IMPALA

## Trunk Floor Pans & Components

### 1769F

1965 Trunk Rear Body Panel

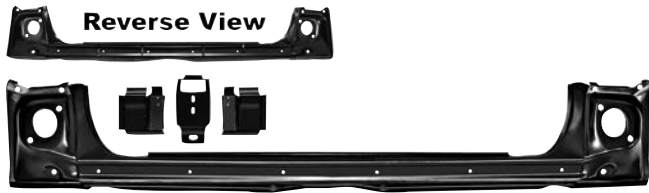

### 1769E

1965 Trunk Rear Cross Rail Brace



### 1769G

1966 Trunk Rear Cross Rail



### 1769CWT

1962 Trunk Cross Rail Panel, (Weld Through Primer), (Excludes Wagon)



### 1769WT

1963 Trunk Cross Rail Panel, (Weld Through Primer), (Excludes Wagon)



### 1769DWT

1964 Trunk Cross Rail Panel, (Weld Through Primer), (Excludes Wagon)



### 1764WT

1965-70 Trunk Floor Pan, Weld-Through Primer, RH



### 1762WT

1965-70 Trunk Floor Pan, Weld-Through Primer, Center



### 1765WT

1965-70 Trunk Floor Pan, Weld-Through Primer, LH

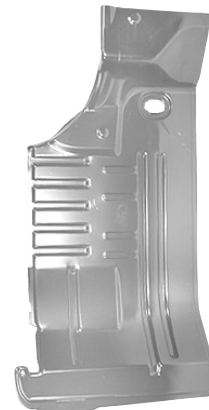

## Trunk Floor Pans & Components

### 1735AWT

1962 Trunk Floor Drop Off, Weld Through Primer, RH

### 1735BWT

1962 Trunk Floor Drop Off, Weld Through Primer, LH

1735AWT



### 1735R

1964 Trunk Floor Drop Off, RH

### 1735L

1964 Trunk Floor Drop Off, LH

1735R



### 1736R

1963 Trunk Floor Drop Off, RH

### 1736L

1963 Trunk Floor Drop Off, LH

1736R



### 1737RWT

1965-66 Trunk Floor Drop Off, Weld-Through Primer, RH

### 1737LWT

1965-66 Trunk Floor Drop Off, Weld Through Primer, LH

1737RWT



### 1781AWT

1965-70 Trunk Divider Panel, Weld-Through Primer



Underside View

# IMPALA

## Trunk Floor Pans & Components

### 1763AWT

1965 Trunk Floor / Divider Panel w/ Tank Mounts, Braces, Drop Offs, Weld Through Primer

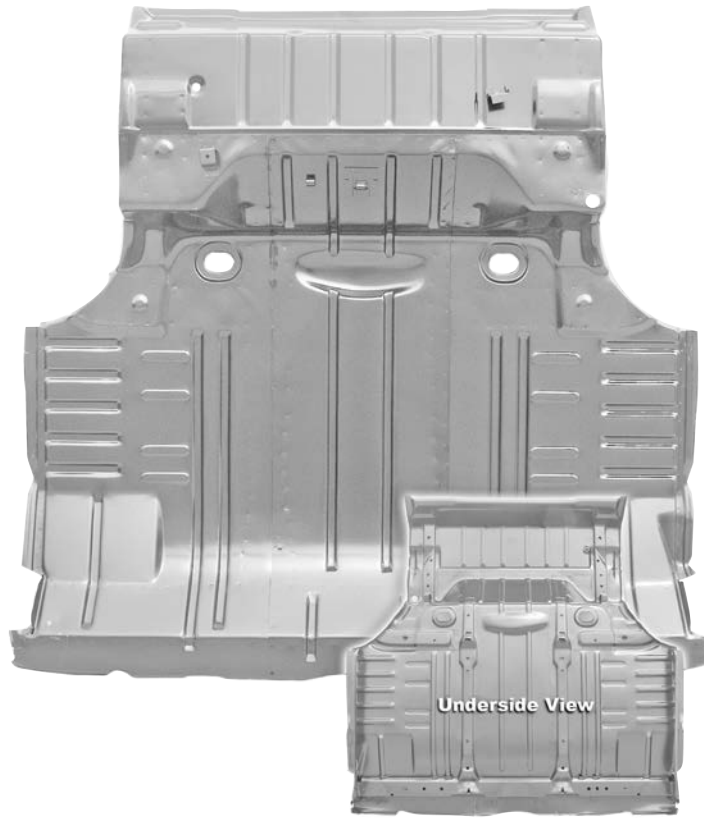

### 1763WT

1966 Trunk Floor / Divider Panel w/ Tank Mounts, Braces, Drop Offs, Weld Through Primer

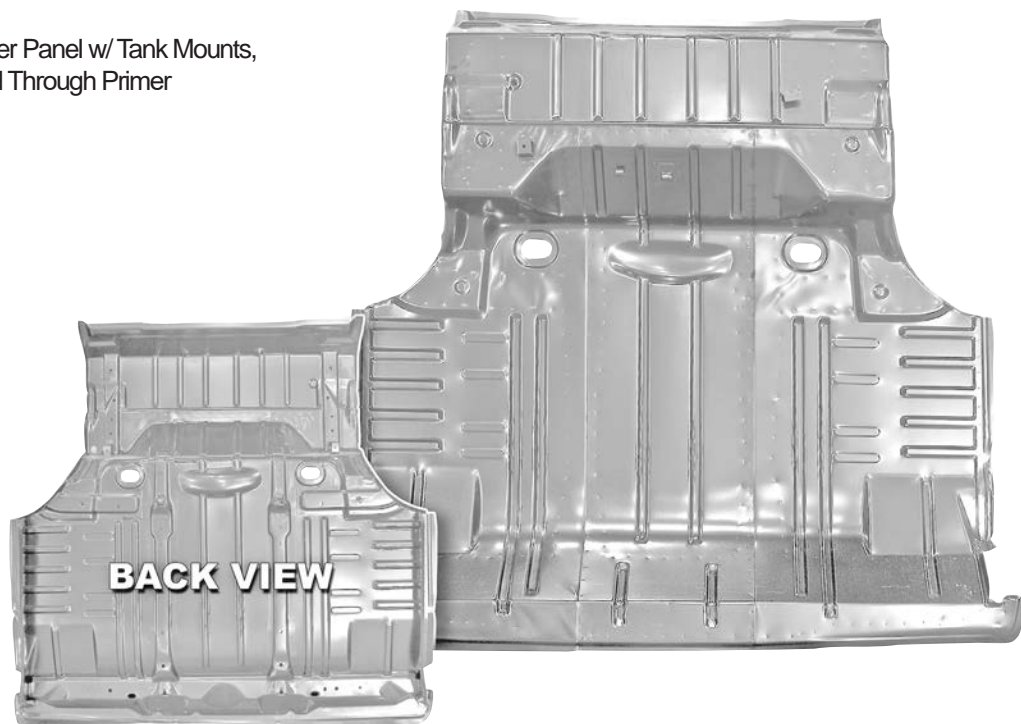



## Trunk Floor Braces

### 1768RWT

1965-70 Trunk Floor Under Brace, Weld Through Primer, RH

### 1768LWT

1965-70 Trunk Floor Under Brace, Weld Through Primer, LH



### 1766RWT

1965-70 Trunk Floor Side Brace, Weld Through Primer, RH

### 1766LWT

1965-70 Trunk Floor Side Brace, Weld Through Primer, LH



## Rocker Panels

### 1788WT

1962-64 Complete Rocker Panel, RH, Weld Through Primer

### 1789WT

1962-64 Complete Rocker Panel, LH, Weld Through Primer



### 1788BWT

1962-64 Inner Rocker Panel, RH, Weld Through Primer

### 1789BWT

1962-64 Inner Rocker Panel, LH, Weld Through Primer



### 1788A

1962-64 Outer Rocker Panel, RH, 2 Door Only

### 1789A

1962-64 Outer Rocker Panel, LH, 2 Door Only



### 1786WT

1965-70 Rocker Panel, Inner, RH, Weld Through Primer

### 1787WT

1965-70 Rocker Panel, Inner, LH, Weld Through Primer

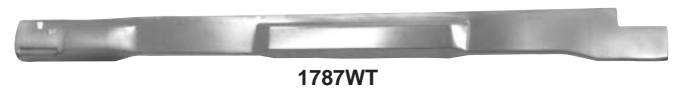

## Roof Drip Rails

### 1795

1962-64 Roof Drip Rails



**Close Up View**

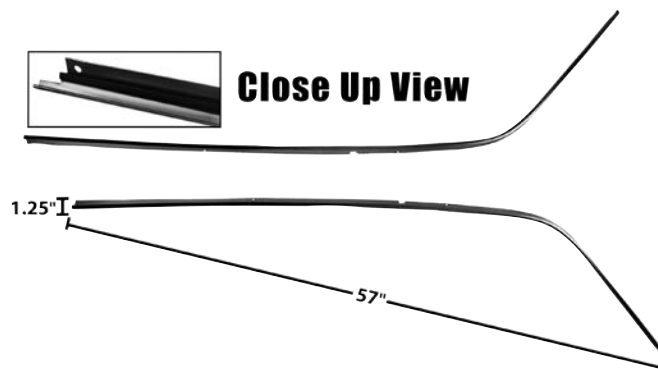

## Headliner Clips

### M1418M

1969-70 Headliner Clips, 6 Pcs. / Kit, Large

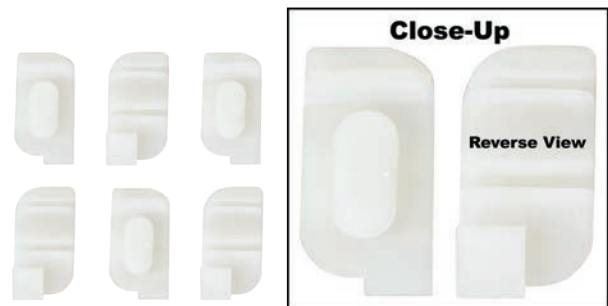

# IMPALA

## Quarter "B" Pillar Panels

### 1733AWT

1963-64 Quarter "B" Pillar Panel, RH,  
Weld Through Primer, Coupe

### 1733BWT

1963-64 Quarter "B" Pillar Panel, LH,  
Weld Through Primer, Coupe

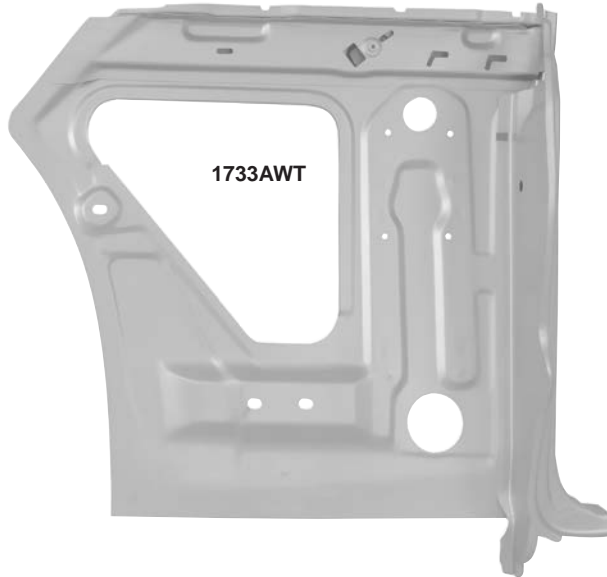

### 1751A

1964 Door Shell, RH

### 1751B

1964 Door Shell, LH



## Doors & Hardware

### 1750

1963 Door Shell, RH

### 1751

1963 Door Shell, LH



### 1463JM

1960-68 Power Window Motor, RH

### 1463KM

1960-68 Power Window Motor, LH



### 1790

1961-64 Window Regulator, RH

### 1791

1961-64 Window Regulator, LH

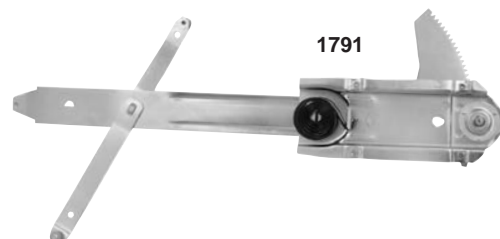

## Doors & Hardware

**1756**  
1962-64 Upper Door Hinge, RH=LH

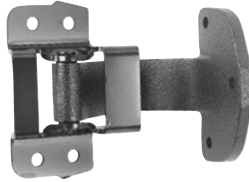

**1758**  
1962-64 Lower Door Hinge, RH

**1759**  
1962-64 Lower Door Hinge, LH

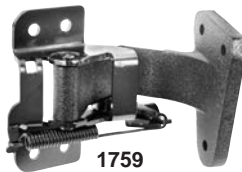

**1076QC**  
1969-76 Upper Door Hinge, RH

**1076QD**  
1969-76 Upper Door Hinge, LH



**1076QA**  
1969-76 Lower Door Hinge, RH=LH



**1752**  
1963 Door Latch, RH

**1753**  
1963 Door Latch, LH



**1755A**  
1965-66 Door Latch, RH

**1755B**  
1965-66 Door Latch, LH



**1757**  
1963-64 Door Catch, Assembly

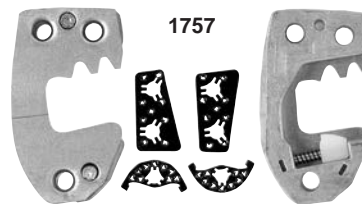

**1076FE**  
1964-70 Door Lock Striker



## Door Accessories

**M1716A**  
1961-62 Door Handle Push Button Kit



**M1717A**  
1963-64 Door Handle Push Button Kit



**M1605**  
1958-65 Interior Door Handle, Single Arm



**M1717J**  
1959-67 Interior Door Handles



**M1037D**  
1968-70 Interior Standard Door Handle, RH

**M1037E**  
1968-70 Interior Standard Door Handle, LH



**M1785**  
1960 Exterior Door Handles, For 2 Door



# IMPALA

## Door Accessories

### M1786

1960 Exterior Front Door Handles,  
For 4 Door



### M1787

1960 Exterior Rear Door Handles,  
For 4 Door

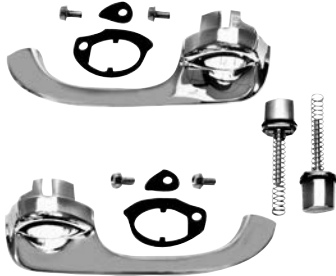

### M1716

1961-62 Exterior Front Door Handles,  
For 2/4 Door



### M1789

1961-62 Exterior Rear Door Handles,  
For 4 Door



### M1717

1963-64 Exterior Front Door Handles,  
For 2/4 Door



### M1791

1963-64 Exterior Rear Door Handles,  
For 4 Door



### M1792

1965-68 Exterior Door Handles,  
For 2 Door

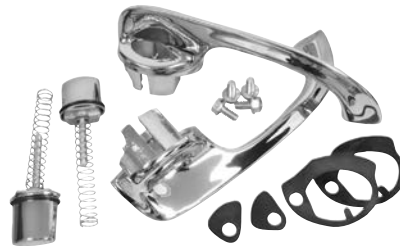

### M1793

1965-68 Exterior Front Door Handles,  
For 4 Door



### M1794

1965-68 Exterior Rear Door Handles,  
For 4 Door

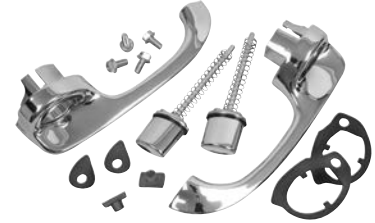

### M1795

1969-70 Exterior Door Handles,  
For 2 Door



### M1796

1969-70 Exterior Front Door Handles,  
For 4 Door



### M1797

1969-70 Exterior Rear Door Handles,  
For 4 Door



## Door Accessories

### M1392M

1965-66 Vent Window Crank, Chrome Knob



### M1392L

1965-66 Vent Window Crank, Black Knob



### M1776

1965-66 Window Crank, Black Knob



### M1382

1966-67 Window Crank, Chrome Knob



### M1392N

1967 Vent Window Crank, Black Knob



### M1382A

1967 Window Crank, Black Knob



### M1037A

1968 Window Crank, Black Knob



### M1037B

1968-70 Window Crank, Clear Knob



### M1392H

1958-64 Single Arm, Vent Window Crank, Chrome Knob



### M1392G

1959-60 Single Arm, Vent Window Crank, Black Knob



### M1392F

1959-64 Double Arm, Vent Window Crank, Chrome Knob



### M1392E

1961-64 Double Arm, Vent Window Crank, Black Knob



### M1392C

1958-64 Single Arm, Window Crank, Black Knob



### M1392D

1958-64 Single Arm, Window Crank, Black Knob w/ Chrome Button



### M1392B

1959-64 Double Arm, Window Crank, Chrome Knob



### M1392A

1961-64 Double Arm, Window Crank, Black Knob





# IMPALA

## Door Accessories

**1751C**  
1961-64 Vent Window Actuator, RH

**1751D**  
1961-64 Vent Window Actuator, LH

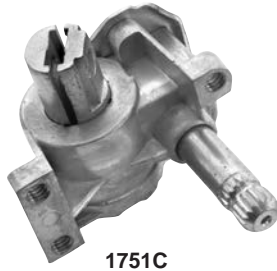

**1751E**  
1965 Vent Window Actuator, RH

**1751F**  
1965 Vent Window Actuator, LH

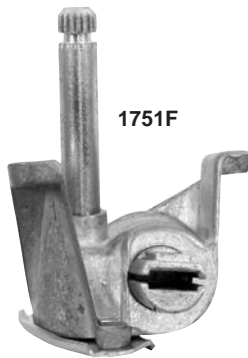

## Quarter Panels

**1729B**  
1962 Quarter Panel Full, RH

**1729C**  
1962 Quarter Panel Full, LH



**1732**  
1964 Quarter Panel, RH

**1733**  
1964 Quarter Panel, LH

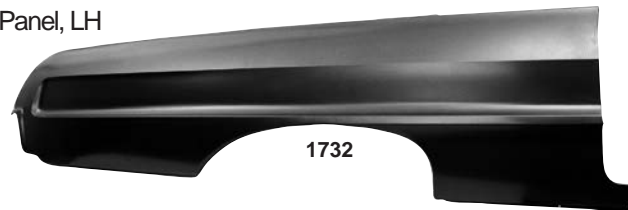

**1730**  
1963 Quarter Panel, RH, 2 Door Only

**1731**  
1963 Quarter Panel, LH, 2 Door Only



## Wheelhouses & Components

**1739D NEW**  
1961-64 Wheelhouse Inner, RH

**1739E NEW**  
1961-64 Wheelhouse Inner, LH



**1739B**  
1962 Wheelhouse Rear Outer, RH

**1739C**  
1962 Wheelhouse Rear Outer, LH





## Wheelhouses & Components

- 1739F NEW**  
1963 Wheelhouse Outer, RH
- 1739G NEW**  
1963 Wheelhouse Outer, LH

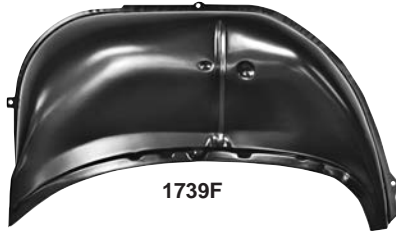

1739F

- 1739H NEW**  
1964 Wheelhouse Outer, RH
- 1739J NEW**  
1964 Wheelhouse Outer, LH



1739H

- 1700A**  
1965-66 Wheelhouse Outer, RH
- 1700B**  
1965-66 Wheelhouse Outer, LH



1700A

- 1744WT**  
1963 Complete Wheelhouse (Inner/Outer),  
Weld Through Primer, Coupe, RH
- 1745WT**  
1963 Complete Wheelhouse (Inner/Outer),  
Weld Through Primer, Coupe, LH



1744WT

- 1740WT**  
1964 Complete Wheelhouse (Inner/Outer),  
Weld Through Primer, Coupe, RH
- 1741WT**  
1964 Complete Wheelhouse (Inner/Outer),  
Weld Through Primer, Coupe, LH

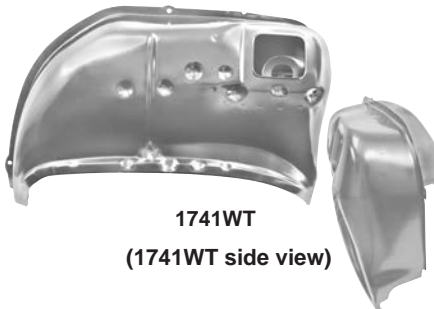

1741WT  
(1741WT side view)

- 1748**  
1965-66 Complete Wheelhouse  
(Inner / Outer), RH
- 1749**  
1965-66 Complete Wheelhouse  
(Inner / Outer), LH



1749

- 1742WT**  
1961-64 Rear Wheelhouse Brace  
Weld Through Primer, RH
- 1743WT**  
1961-64 Rear Wheelhouse Brace,  
Weld Through Primer, Coupe, LH



1743WT

- 1746WT**  
1963-64 Wheelhouse to Rocker Brace,  
Weld-Through Primer, RH
- 1747WT**  
1963-64 Wheelhouse to Rocker Brace,  
Weld-Through Primer, LH



1746WT

- 1746A**  
1963-64 Wheelhouse to Quarter Brace, RH
- 1746B**  
1963-64 Wheelhouse to Quarter Brace, LH



1746B

# IMPALA

## Deck Lid Filler Panel

### 1771B

1964 Deck Lid Filler Panel, 2 Door



### 1771C

1965-66 Deck Lid Filler Panel, 2 Door



## Rear Body Panels

### 1760

1963 Rear Body Panel, 4 Pcs.

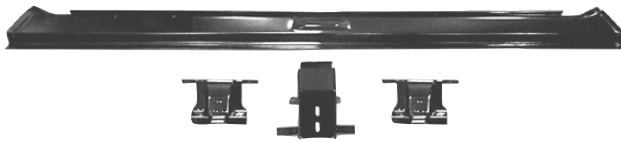

### 1761

1964 Rear Body Panel, 4 Pcs.



## Trunk Lids & Components

### 1770

1963 Trunk Lid, Impala

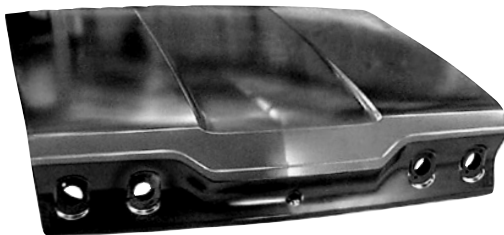

### 1771

1964 Trunk Lid, Impala



### 1771A

1964 Trunk Lid, Biscayne & Bel Air



## Trunk Lids & Components

**1772A**  
1962 Trunk Catch Lock Striker



**1773**  
1960-64 Trunk Lid Hinges  
(Excluding Convertible)



**M1019**  
1967-69 Trunk Latch



## Trunk Weatherstrip Channel

**1769A**  
1962 Trunk Weatherstrip Channel, 4 Pcs.



**1769B**  
1963-64 Trunk Weatherstrip Channel



## Tail Light Mounting Panels

**1733RWT**  
1963 Tail Light Mounting Panel, RH

**1733LWT**  
1963 Tail Light Mounting Panel, LH



## Lic. Plate Brkt.

**1700Z**  
1965 License Plate Bracket



**1734RWT**  
1964 Tail Light Mounting Panel, RH

**1734LWT**  
1964 Tail Light Mounting Panel, LH



## License Plate Frames

**LF64**  
1964 License Plate Frames

**LF71**  
1971 License Plate Frames

**LF72**  
1972 License Plate Frames

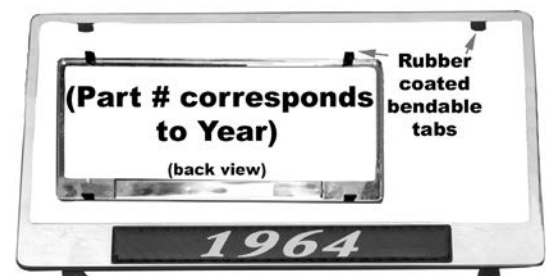

**WHILE SUPPLIES LAST!**

# IMPALA

## Tail Panel Brace

**1781Z**

1965 Tail Panel Brace



**1782**

1966-70 Tail Panel Brace



**Bracket  
Closeup**



**Reverse View**

## Fuel Tanks

**T29A**

1959-60 Galvanized Fuel Tank w/ Drain Plug, 16 Gallon  
Also Fits Bel Air



**T29**

1961-64 Galvanized Fuel Tank, 20 Gallon



**T25C**

1965-66 Galvanized Fuel Tank w/ 8" Neck, 1 Vent Pipe  
Also Fits Bel Air

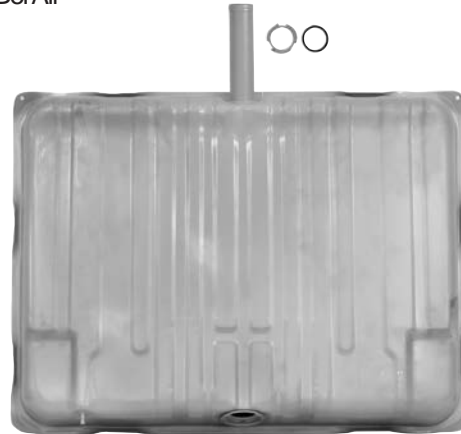

**T29D**

1967 Galvanized Fuel Tank Also Fits Bel Air & Caprice



**T29E**

1967-70 Galvanized Fuel Tank w/o E.E.C., 22 Gallon  
Also Fits Biscayne, Caprice, Wagon



## Fuel Tanks

### T29B

1968 Galvanized Fuel Tank w/ Neck, 24 Gallon



### T29G

1975-76 Galvanized Fuel Tank, 22 Gallon  
Also Fits Bel Air, Caprice, Wagon



### T29C

1969-70 Galvanized Fuel Tank w/o Neck (Hose Included),  
24 Gallon



### T29H

1977-79 Galvanized Fuel Tank, 19 Gallon Also Fits Caprice



### T29F

1970-74 Galvanized Fuel Tank w/ E.E.C., 22 Gallon  
Also Fits Bel Air & Caprice Wagon



## Gas Cap

### T46

1968-70 Gas Cap, Vented



# IMPALA

## Fuel Tank Straps & Brace

### T25D

1959-60 Fuel Tank Straps w/ Bolts, 2 Pcs.



### T25A

1961-64 Fuel Tank Straps w/o Bolts, 2 Pcs.



### T25B

1965-66 Fuel Tank Straps w/o Bolts, 2 Pcs.



### 1767WT

1965-70 Fuel Tank Brace, Weld-Through Primer, RH=LH

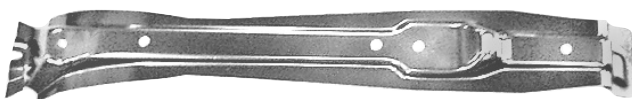

## Fuel Sending Units

### T38

1958-60 Fuel Sending Unit, 5/16"



### T38A

1958-60 Fuel Sending Unit, 3/8"



### T40

1961-64 Fuel Sending Unit, 5/16"

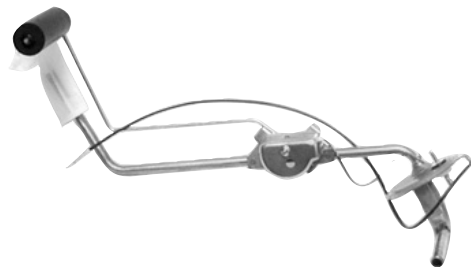

### T40A

1961-64 Fuel Sending Unit, 3/8"

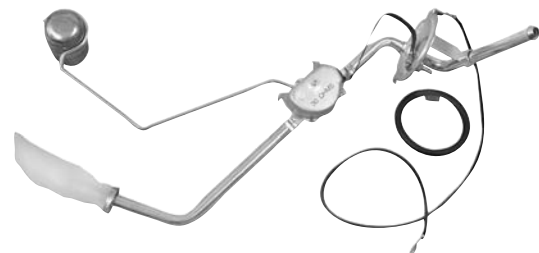



## Fuel Sending Units

### T71

1965-70 Fuel Sending Unit, 3/8"  
( Small Flange )



### T41A

1965-70 Fuel Sending Unit, 5/16"

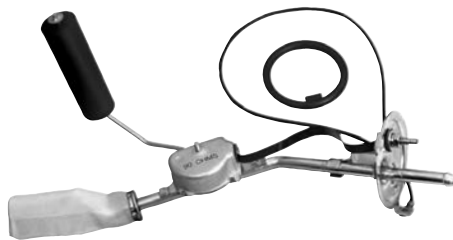

### T41B

1967-70 Fuel Sending Unit, 3/8"  
(90° Bend in Fuel Line )



### T03C

1958-76 Fuel Sending Unit Float



### T20

1961-66 Fuel Sending Unit Locking Ring



### T21

1961-66 Fuel Sending Unit Gasket



### T20A

1959-60 Fuel Sending Unit Gasket



## Grilles & Components

### M1718E

1958 Headlamp Bezels



### M1718F

1959 Headlamp Bezels



### M1719M

1962 Headlamp Bezel, RH

### M1719N

1962 Headlamp Bezel, LH



M1719N

### M1718B

1963 Headlamp Bezels, 4 Pcs. / Set

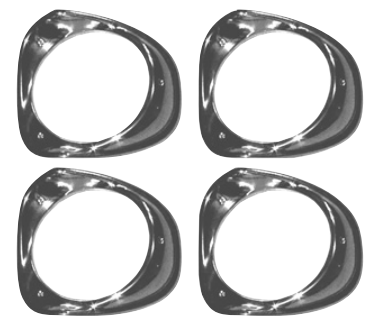

### M1718

1964 Headlamp Bezels, 4 Pcs. / Set



*Headlamp Bezels  
continued on next page*

## Grilles & Components

### M1718C

1965 Headlamp Bezels, 4 Pcs. / Set



### M1724H

1966 Headlamp Bezels

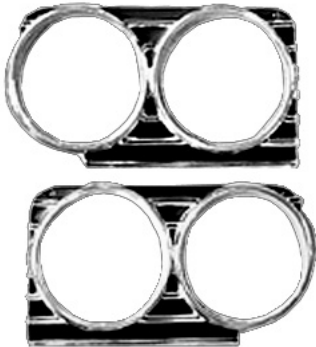

### M1718D

1967 Headlamp Bezels

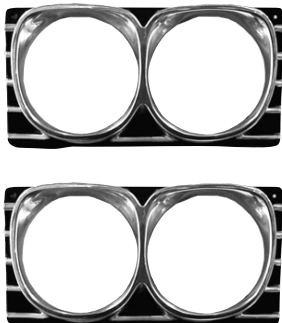

### LH22

1962 Headlamp Bucket, RH

### LH23

1962 Headlamp Bucket, LH



### LH20

1958-66 Headlamp Mounting Bucket Set, 8 Pcs.



### LH31

1958-72 Headlamp Retaining Rings, 4 Pcs.



### M1724A

1963 Upper Eyebrow Moldings

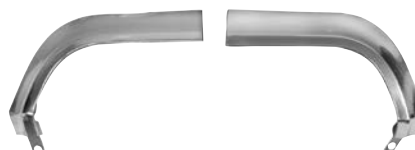

### M1724AB

1963 Lower Eyebrow Moldings



### M1724B

1964 Eyebrow Moldings



### M1724C

1966 Eyebrow Moldings



### M1718G

1967 Upper Eyebrow Moldings



## Grilles & Components

### M1719P

1966 Grille Support / Bumper Filler, 3 Piece Set



### M1719D

1961 Upper Grille Molding

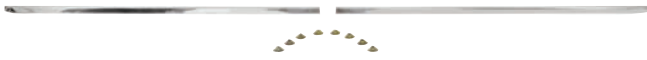

### M1724W

1964 Lower Grille Molding



### M1719J

1962 Top Grille Molding



### M1719K

1962 Top Grille Molding Fasteners, 11 Pcs.



### M1719

1961 Upper Grille



### M1719A

1961 Grille w/o Emblem



### M1719H

1962 Grille



### M1719FC

1963 Complete Grille w/ Brackets, Headlamp Housings



### M1719F

1963 Grille



### M1719L

1964 Grille



*Grilles & Components continued on next page*

# IMPALA

## Grilles & Components

### M1719B

1964 Grille w/ Brackets & Headlamp Housings



### M1719C

1965 Grille



### M1719GA

1966 Upper Grille



### M1719G

1966 Lower Grille, 3 Pcs.



### M1719E

1961 Grille Emblem Bezel



### 1729A

1962 Cowl Vent Grille



## Wiper Blades & Arms

### 1702T

1963 Wiper Motor Transmission Arm

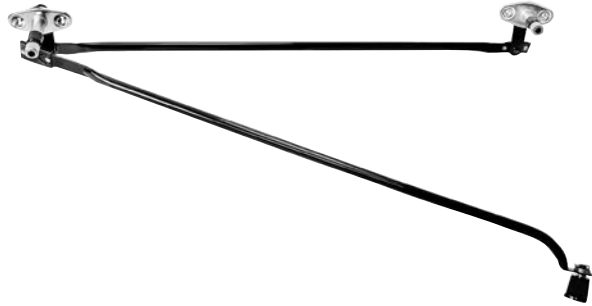

### 1702U

1964 Wiper Motor Transmission Arm

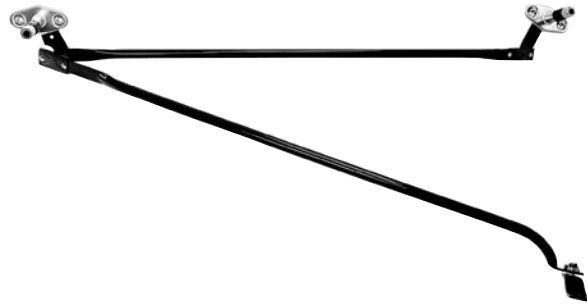

### K119

1963-64 Wiper Arms



### K118

1965-67 Wiper Arms



### M1029E

1959-67 Wiper Blades



Sales: 866.640.1324

[info@goldenleafautomotive.com](mailto:info@goldenleafautomotive.com)

## Hood Spears & Molding

**M1725A**  
1962 Hood Molding



**M1725B**  
1963 Hood Molding



**M1725C**  
1964 Hood Molding



**M1724E**  
1965 Hood Spear



**M1724D**  
1964 Hood Spear



**M1724F**  
1966 Hood Spear



## Front Fender Molding & Ornaments

**EM1721**  
1962 Fender Ornaments



**EM1720**  
1961 Fender Ornaments

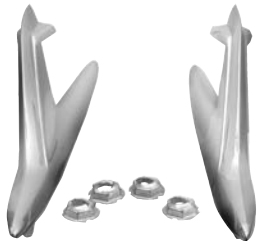

**EM1750**  
1963 Fender Moldings, 4 Pcs.



**M1707**  
1966 Front Fender Extension Moldings



**M1706A**  
1964 Lower Fender Moldings



# IMPALA

## Exterior Mirrors

**4026**  
1958 Exterior Mirror



**M1036A**  
1959-60 Exterior Mirror w/ "Bow Tie"



**M1036B**  
1961-62 Exterior Mirror



**M1035**  
1963-64 Exterior Mirror w/ "Bow-Tie"



**M1036C**  
1965-66 Exterior Mirror, RH

**M1036D**  
1965-66 Exterior Mirror, LH



**M1036E**  
1967 Exterior Mirror w/ Gaskets & Hardware, RH

**M1036F**  
1967 Exterior Mirror w/ Gaskets & Hardware, LH

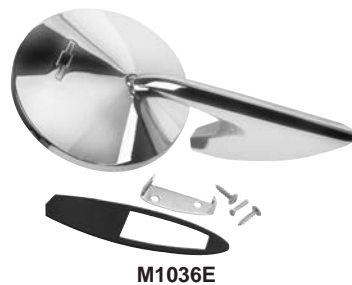

**3921816**  
1968 Remote Mirror, LH



**M1032**  
1968 Exterior Mirror w/ "Bow-Tie"



**M1030**  
1968-69 Exterior Mirror, RH

**M1031**  
1968-69 Exterior Mirror, LH





## Drip Rail Molding

### M1738

1962-64 Drip Rail Moldings

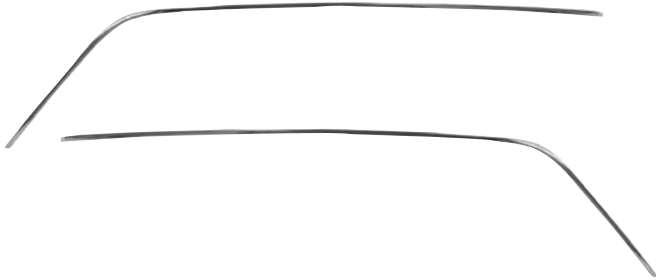

## Door Molding

### B220300

1961 Door Molding, Set ( Both Doors; Upper, Lower, Wide )



## Windshield Moldings

### M1724J

1963-64 Windshield Moldings, 5 Pc., Set



### M1724L

1965-67 Windshield Moldings, 5 Pc., No Clips, Set



## Wheel Opening Moldings

### M1729

1965 Wheel Opening Molding Set, 4 Pcs.

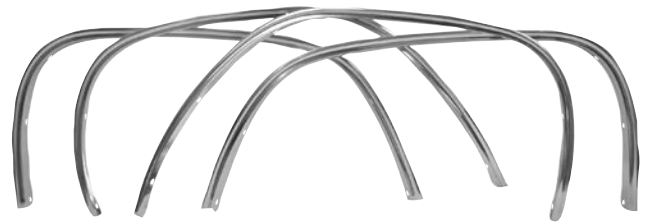

### M1730

1966 Wheel Opening Molding Set, 4 Pcs.

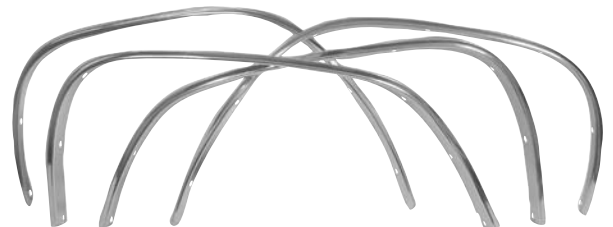

*Wheel Opening Moldings  
continued on next page*

## Wheel Opening Moldings

### M1731

1967 Wheel Opening Molding Set, 4 Pcs.



### M1732

1968 Wheel Opening Molding Set, 4 Pcs



### M1733A

1969 Wheel Opening Molding Set, 4 Pcs



### M1733

1970 Wheel Opening Molding Set, 4 Pcs



### M1700

1977-79 Front Wheel Opening Molding, RH

### M1701

1977-79 Front Wheel Opening Molding, LH



M1700

### M1702

1977-79 Rear Wheel Opening Molding, RH

### M1703

1977-79 Rear Wheel Opening Molding, LH

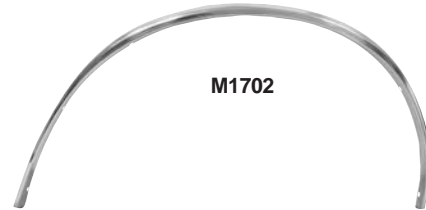

M1702

### M1710

1980-90 Front Wheel Opening Molding, RH

### M1711

1980-90 Front Wheel Opening Molding, LH



M1710

### M1712

1980-90 Rear Wheel Opening Molding, RH

### M1713

1980-90 Rear Wheel Opening Molding, LH

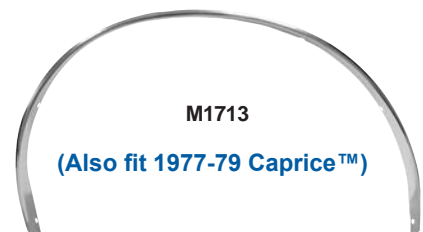

M1713

(Also fit 1977-79 Caprice™)

## Rocker Panel Mldgs.

### M1750

1961-64 Rocker Panel Molding w/ Clips,  
RH, Standard

M1750



### M1751

1961-64 Rocker Panel Molding w/ Clips,  
LH, Standard

### M1754

1965-66 Rocker Panel Molding, "SS", Pair



### M1756

1968-69 Rocker Panel Molding, "SS", Pair



### M1751C

1962-64 Rocker Panel Molding Clips, 6 Pcs.

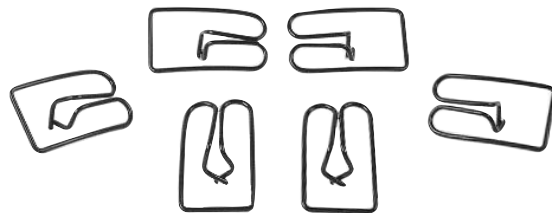

### M1430CLP

1965 Rocker Panel Molding Clips, 6 Pcs. ( Except "SS" )  
1966-67, 69 All Styles, 1968 "SS" Only



## Body Side Molding

### M1705

1963 Body Side Molding Set, 6 Pcs.

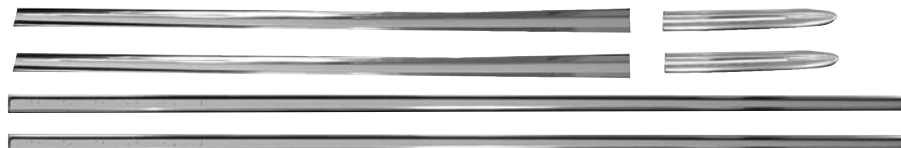

*Body Side Moldings continued on next page*

# IMPALA

## Body Side Molding

### M1705E

1964 Body Side Molding Clips, 178 Pcs.



(One clip assy. shown)

### M1705F

1964 Body Side Molding Clips



(One clip assy. shown)

## Rear Window Molding

### M1724N

1962-64 Rear Window Moldings, 5 Pcs.



### M1705H

1962-64 Rear Window Moldings Clips, 6 Pcs. (Hard Top Only)



### M1724M

1965-66 Rear Window Moldings, 5 Pcs., "SS"

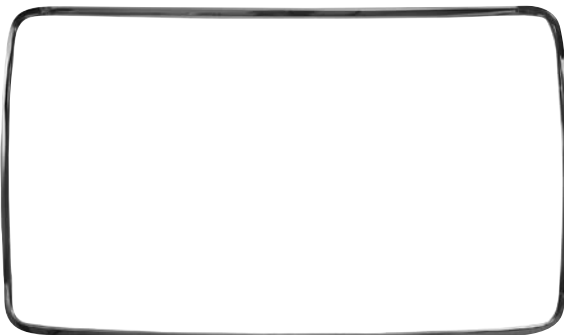

## Quarter Panel Molding

### B222500

1961 Upper Quarter Panel Molding, RH 2 Door

### B222000

1961 Upper Quarter Panel Molding, LH 2 Door

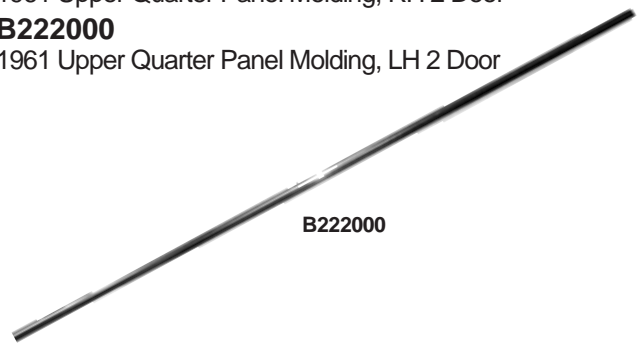

B222000

### B223500

1961 Lower Quarter Panel Molding, RH 2 Door

### B223000

1961 Lower Quarter Panel Molding, LH 2 Door

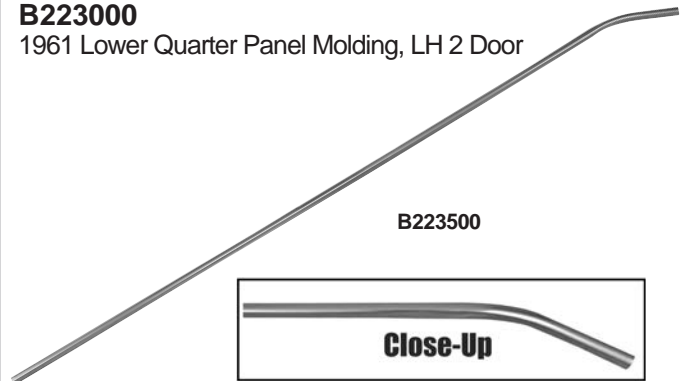

B223500

Close-Up

### M1706C

1964 Rear "C" Moldings



## Quarter Panel Molding

### B223600

1961 Rear Wrap-Around Moldings



### B231650

1966 Rear Wrap-Around Moldings, RH=LH



## Trunk Molding

### B223650

1961 Trunk Moldings



### B223900

1962 Upper Trunk Molding



### M1725P

1963 Upper Trunk Lid Molding



### B230000

1964 Upper Trunk Molding, Belair / SS



### B226000

1963 Lower Trunk Molding w/ Clips



### B231000

1964 Lower Trunk Molding, Belair / SS



### B223950

1962 Tail Lamp Cove Moldings



# IMPALA

## Trunk Molding

### M1725Q

1963 Rear Cove Corner Moldings



### B230500

1964 Outer Cove Moldings, Belair / SS



### B231500

1964 Inner Cove Moldings, Belair / SS



### M1724X

1964 Standard Rear Panel Molding w/ Clips



### M1724Y

1964 Quarter Extension Molding w/ Clips, RH, Standard



M1724Y

### M1724G

1964 Trunk Spear w/ Clips



M1724G

### B231660

1966 Trunk Lid Molding w/ Clips



## License Panels

### B245000

1962 Rear License Panel



### B245500

1963 Front License Panel

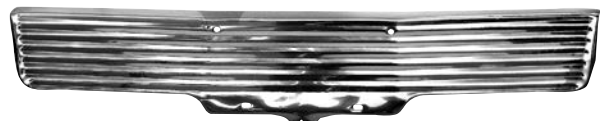



## License Panels

### B246000

1963 Rear License Panel



### B246500

1964 Front License Panel



### B247000

1964 Rear License Panel



### M1780

1962-64 License Panel Clips, 50 Pc. Set



## Emblems

### EM2102

1961 Grille Flag Emblem



### EM1730

1962 Chrome Hood Emblem w/ Bezel



### EM2161

1962-63 "V" Front Fender Emblems



### EM1700

1962 Quarter Panel Emblems



*Emblems continued on next page*

# IMPALA

## Emblems

### EM1701

1962 "SS" Quarter Panel Emblems



### EM1702

1963 Quarter Panel Emblems



### EM2171

1962 "Impala" Rear Quarter Panel Script Emblems



### EM1703

1963 "SS" Quarter Panel Emblems



### EM1761

1962 Chrome Trunk Emblem w/ Bezel



### EM2255

1963 "Impala" Rear Quarter Molding Letters Set



### EM1760

1962 "Impala SS" Trunk Emblem



### EM1762

1963 Chrome Trunk Emblem w/ Bezel



### EM2202

1963 Hood Emblem Assembly



### EM1732

1964 Hood Emblem, Insert Only



## Emblems

### EM1740

1964 "Chevrolet" Script Grille Emblem



### EM1704

1964 Quarter Panel Emblems



### EM1705

1964 "SS" Quarter Panel Emblems



### EM1710

1964 "SS" Trunk Emblem



### EM1712

1964 "SS" Trunk Emblem



### EM1763

1964 Chrome Trunk Emblem w/ Bezel



### EM1765

1964 "Chevrolet" Rear Deck Letters Set  
(Includes Mounting Tool)



### EM1742

1965 "Impala SS" Grille Emblem



### EM1733

1965 Hood Emblem Assembly



### EM1706

1965 Door Panel Emblems



### EM1764

1965 Chrome Trunk Emblem w/ Bezel



### EM1766

1965 "Impala SS" Lower Rear End Emblem



*Emblems continued on next page*

# IMPALA

## Emblems

### EM1743

1966 "Chevrolet" Script Grille Emblem



### EM1744

1966 "Chevrolet Impala SS" Grille Emblem



## Exterior Electrical & Components

### 1702YC

1963 Antenna Kit, Rear, RH, w/o Cable

### 1702YD

1963 Antenna Kit, Rear, LH, w/o Cable



### 1702YR

1964 Antenna Kit, Rear, RH, w/ Cable

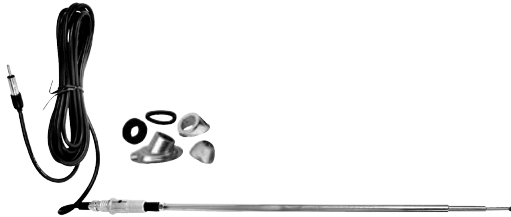

### 1702YL

1964 Antenna Kit, Rear, LH, w/o Cable



### 1702W

1963-66 Telescoping Antenna, Mast only ('63 Front Mount, '64-'66 Rear Mount)



### 1702ZR

1965-66 Telescoping Antenna w/ Cable, Rear RH



### 1702ZL

1965-66 Telescoping Antenna w/o Cable, Rear LH



### 1702X

1965-66 Telescoping Antenna w/ Cable (Front Mount)



### 1000C

1967-69 Replacement Antenna Mast



### 1702ZX

1958-66 Cable for Rear Mount Antenna



## Exterior Electrical & Components

**1714A**

1960 Back Up Lens, Clear



**1714B**

1961 Back Up Lens, White / Red



**1714D**

1963 Back Up Lens, White / Red



**1713**

1964 Back Up Lens, White / Red w/ Trim



**1714F**

1965 Back Up Lens



**L1711**

1968 Back Up Lens, also for Caprice



**L1713**

1968 Backup Lens, also for Bel Air / Biscayne



**CBL6251LED**

1962 Back Up Lamp, LED, Red/Clear



**CBL6311PRLED**

1963 Back Up Lamp Assembly, LED



**1713A**

1964 Back Up Lamp Assembly



**CBL6451LED**

1964 Back Up Lamp, LED, Red / Clear



**CBL6551LED**

1965 Back Up Lamp, LED, Red / Clear



**CBL6851LED**

1968 Back Up Lamp, LED, Red / Clear



**1710A**

1962 Tail Lamp Lens, Red



**1711**

1963 Tail Lamp Lenses, 3 Pcs. w/ Chrome Trim



*Tail Lamp Lenses  
continued on next page*

# IMPALA

## Exterior Electrical & Components

**1712**

1964 Tail Lamp Lens, Red  
w/ Chrome Trim



**1714E**

1963 Tail Lamp Lens Trim



**CTL6301LED**

1963 Tail Lamp, LED, Red



**1714**

1965 Tail Lamp Lens, Red  
w/ Chrome Trim



**1710B**

1962 Tail / Back Up Lamp Lens Trim,  
Chrome



**CTL6401LED**

1964 Tail Lamp, LED, Red



**L1712**

1968 Tail Lamp Lens, w/o Chrome Trim  
Bel Air / Biscayne



**1734A**

1963 Tail Lamp Housing, RH, (3 per car)

**1734B**

1963 Tail Lamp Housing, LH, (3 per car)



1734A

**CTL6501LED**

1965 Tail Lamp, LED, Red



**L1710**

1968 Tail Lamp Lens, Also for Caprice,  
Red



**1734C**

1964 Tail Lamp Housing



**CTL6801LED**

1968 Tail Lamp, LED, Red w/ Trim





## Exterior Electrical & Components

**1715A**  
1962 Tail Lamp Surround, RH

**1715B**  
1962 Tail Lamp Surround, LH



1715A

**1715C**  
1966 Tail Lamp Surround, RH

**1715D**  
1966 Tail Lamp Surround, LH



1715D

**1714G**  
1965 Tail / Back Up Lamp Bezel, RH

**1714H**  
1965 Tail / Back Up Lamp Bezel, LH



1714G

**1714J**  
1967 Tail Lamp Bezels, Chrome



**1709W**  
1961 Parking Lamp Lens, Clear



**1709X**  
1962 Parking Lamp Lenses, Amber



**1709Y**  
1962 Parking Lamp Lenses, Clear



**1710H**  
1965 Parking Lamp Lenses, Amber



**1710JL**  
1966 Parking Lamp Lens, LED

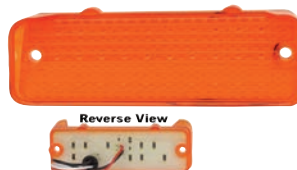

Reverse View

**1710J**  
1966 Parking Lamp Lenses, Amber



**1710K**  
1967 Parking Lamp Lenses, Amber



**1710KL**  
1967 Parking Lamp Lenses, LED



Reverse View

**1710**  
1964 Parking Lamp Assembly

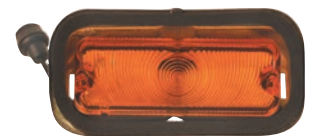

**1710F**  
1963 Parking Lamp Housing, RH=LH



# IMPALA

## Exterior Electrical & Components

### C6651

1966 Parking Lamp Gasket, Pair

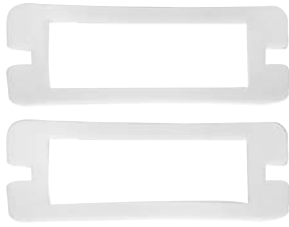

### C6751

1967 Parking Lamp Gasket, Pair



### 1710N

1967 Park Lamp Bezels, Chrome



### 1710L

1968 Park Lamp Lens, RH, Clear

### 1710M

1968 Park Lamp Lens, LH, Clear



1710L

## Glass & Seals

### M1727B

1961-62 Vent Window Seals, 4 Pcs.  
2 Door



### M1727C

1963-64 Vent Window Rubber Seals,  
4 Pcs. 2 Door



### M1727D

1961-62 Vent Window Bumper, Pair  
Convertible



### M1727E

1963-64 Vent Window Bumpers, Pair  
Hard Top



### M1727F

1963-64 Vent Window Bumper, Pair  
Convertible



### M1727A

1961-64 Quarter Window Stopper,  
2 Door, Convertible



### M1727

1961-64 U-Jamb Rubber Seals, Coupe



### 1751G

1962-64 Door Glass Assembly, RH, Hard Top

### 1751H

1962-64 Door Glass Assembly, LH, Hard Top

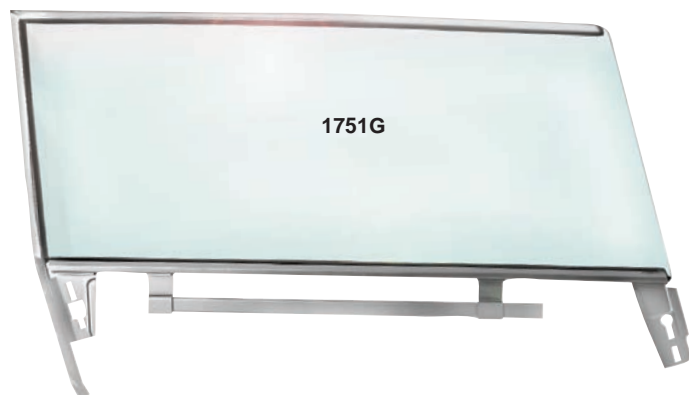

1751G

## Glass & Seals

### M1717E

1961-64 Door Window Lower Frame, RH

### M1717F

1961-64 Door Window Lower Frame, LH

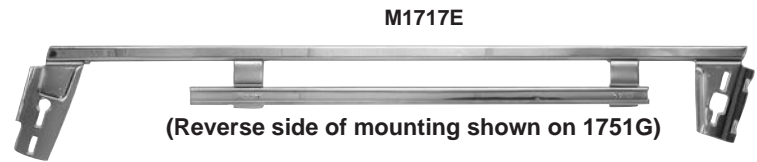

## Heating / Cooling Components

### 1709A

1963 Heater Core Case



### 1709

1963-64 Heater Box Assembly (Metal)



### 1717R

1963 Fresh Air Vent Assembly, RH, Chrome Knob

### 1717L

1963 Fresh Air Vent Assembly, LH, Chrome Knob



## Pedal & Shifter Components

### 1702G

1963 Parking Brake Assembly



### 1702H

1964 Parking Brake Assembly



### 1702J

1965 Parking Brake Assembly



# IMPALA

## Pedal & Shifter Components

**M1726N**  
1958-64 Brake Pedal Pad  
(w/o Power Brakes)



**M1726P**  
1958-64 Brake Pedal Pad  
(Power Brakes)



**M1726C**  
1965-70 Brake Pedal Pad,  
Manual Transmission

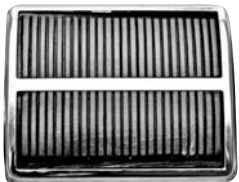

**M1726D Not Included**

**M1726E**  
1965-70 Parking Brake Pedal Pad



**M1726A**  
1965-70 Disc Brake Pedal Pad,  
Automatic Transmission



**M1726B Not Included**

**M1726J**  
1958-63 Accelerator Pedal Pad



**M1726D**  
1965-70 Brake Pedal Pad Trim  
Manual Transmission



**M1726F**  
1965-70 Parking Brake Pedal Pad Trim



**M1726B**  
1965-70 Disc Brake Pedal Pad Trim



**M1726G**  
1965-70 Accelerator Pedal Pad  
**M1726H**  
1965-70 Accelerator Pedal Pad Trim

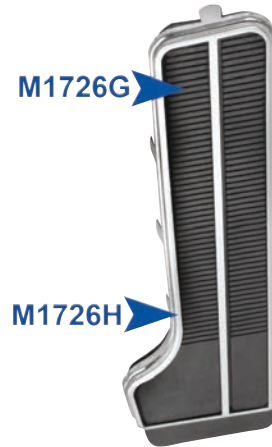

**1708**  
1962-64 Clutch Counter-Shaft (Z-Bar)



**1708A**  
1965-70 Clutch Counter-Shaft (Z-Bar)



## Pedal & Shifter Components

**M1339**

1963-67 Parking Brake Release Handle



**3893179**

1968-72 Parking Brake Release Handle



**1498G**

1964-67 Shifter Lever w/ Push Button, Automatic



## Steering Wheels & Components

**769868**

1962 Steering Wheel, Black



**3939731**

1969-70 Steering Wheel, Black



**SW12**

1969-70 Steering Wheel, 3-Spoke Comfort





# IMPALA

## Steering Wheels & Components

### 1709M

1961-62 Steering Column Seal  
w/ 2 Screws, Automatic Transmission



### 1709N

1961-62 Steering Column Seal w/  
2 Screws, 4 Spd. Manual Transmission



### 1709P

1963-64 Steering Column Seal w/ 2  
Screws, Automatic Transmission

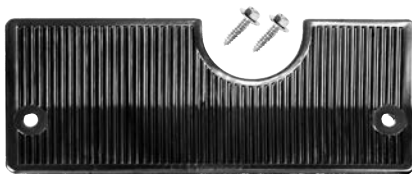

### 1709Q

1963-64 Steering Column Seal w/  
2 Screws, 4 Spd. Manual Transmission



### 1709J

1963 Transmission Indicator Bezel



### 1709K

1964 Transmission Indicator Bezel

### 1709L

1963-64 Transmission Indicator Lens,  
Clear w/ Etched Letters

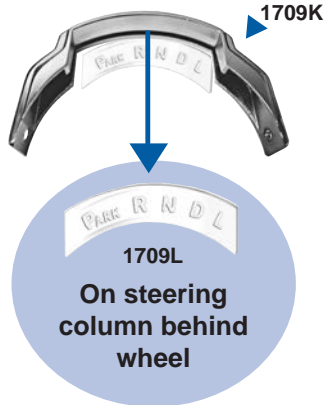

## Sun Visor Brackets

### M1338

1964-68 Sun Visor Support Bracket



Now includes  
bushing and screws!

## Rear View Mirrors

### 1154D

1958-62 Rear View Mirror, 10 in.,  
Day / Night



### 1154C **NEW**

1958-62 Rear View Mirror, Stainless



Reverse View

### 916177

1963-64 Rear View Mirror, 8 Inch



### M1035C

1963-66 Rear View Mirror, 8 Inch,  
Standard



### 911366

1965-72 Rear View Mirror, 10 Inch





## Rear View Mirrors

### M1035A

1969-70 Rear View Mirror, 12 Inch, Day/Night



### M1036J

1961-64 Rear View Mirror Bracket, Chrome (Hard Top & Sedan)



### M1036K

1965-68 Rear View Mirror Bracket, Chrome



## Door Trims & Arms Rests

### M1714A

1962-64 Arm Rest Pad, Pair



### M1714

1962-64 Arm Rest Bases, Chrome

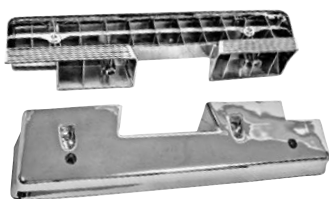

### M1715

1965-67 Arm Rest Bases, Chrome

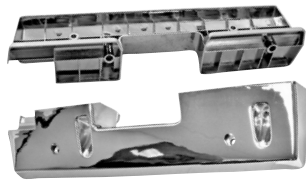

### M1770

1961-67 Door Lock Knobs, Black



### M1771

1961-67 Door Lock Knobs, Chrome



### M1772

1967 Door Lock Knobs, Black



### M1773

1967 Door Lock Knobs, Chrome



### M1777

1968 Door Lock Knobs, Black



## Scuff Plates

### M1734

1961-64 Scuff Plate, RH

### M1735

1961-64 Scuff Plate, LH



M1734

### M1736

1965-70 Scuff Plate, RH

### M1737

1965-70 Scuff Plate, LH



M1737

# IMPALA

## Carpet Guard

**1709C**

1965-66 Firewall Carpet Guard w/ Screws

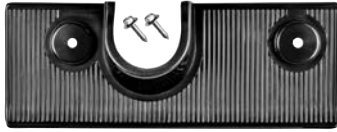

**1709D**

1967-68 Firewall Carpet Guard w/ Screws



## Seats & Components

**1402P**

1966-72 Seat Side Support Spring, 4 Pc+8 Clip

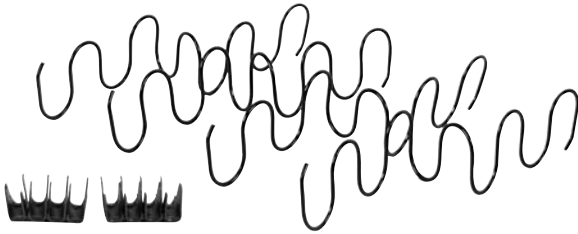

**1700GE**

1962-64 Seat Track 2 Pcs., RH

**1700GF**

1962-64 Seat Track 2 Pcs., LH

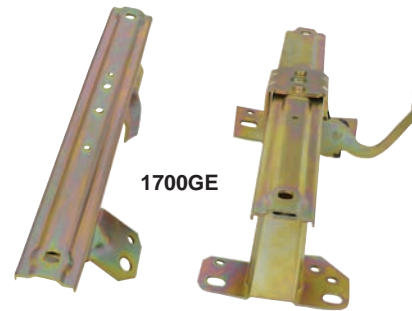

**1401**

1966-68 Seat Frame Assembly w/ Springs, RH

**DYNACORN EXCLUSIVE!**

**1402**

1966-68 Seat Frame Assembly w/ Springs, LH

**DYNACORN EXCLUSIVE!**

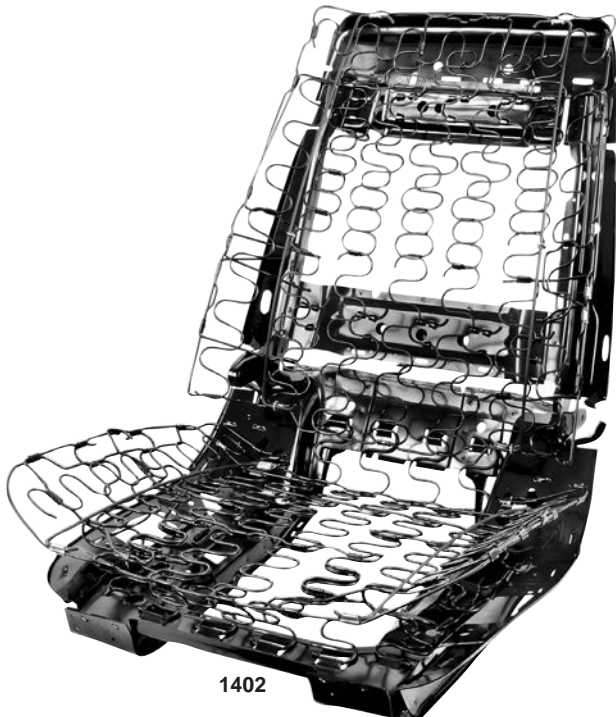

**1402A**

1969 Seat Frame Assembly w/ Springs, RH=LH

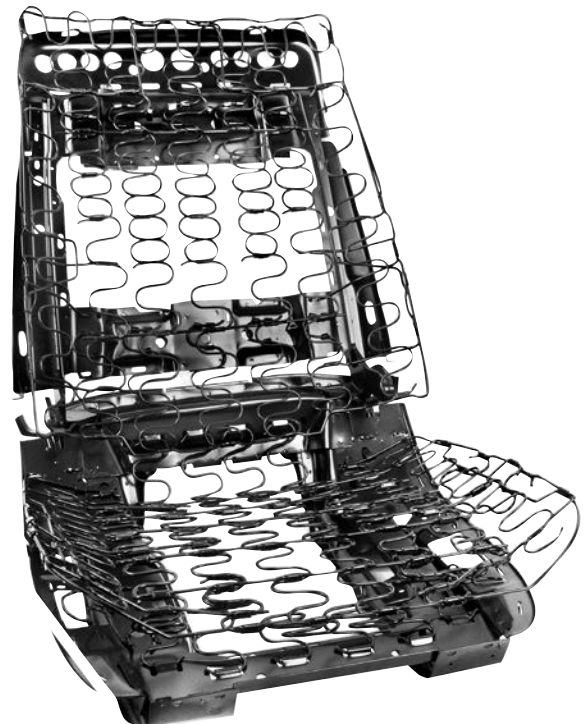

## Seats & Components

**1776**

1962-65 Seat Bottom Spring, RH=LH



**1402K**

1966-69 Seat Bottom Spring, RH=LH

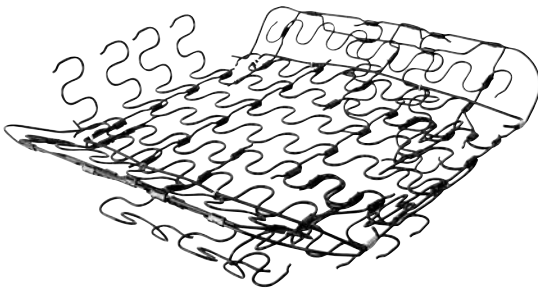

**1777**

1962-65 Seat Back Spring, RH=LH

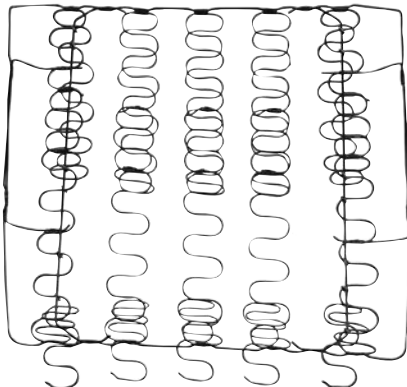

## Seat Molding

**M1760**

1961-64 Front Seat Back Molding Set, 2 Pcs.



**M1761**

1965 Front Seat Top Molding Set, 3 Pcs.



**M1709**

1962-64 Bucket Seat Molding Set, 3 Pcs., RH

**M1709A**

1962-64 Bucket Seat Molding Set, 3 Pcs., LH



# IMPALA

## Seat Belts



**Seat Belts with Push Button:  
6 colors to choose from**



60 Inch Belts

SB-N2PB	Seat Belt with Push Button	<b>Black</b>
SB-N2PG	Seat Belt with Push Button	<b>Grey</b>
SB-N2PT	Seat Belt with Push Button	<b>Tan</b>
SB-N2PN	Seat Belt with Push Button	<b>Navy Blue</b>
SB-N2PR	Seat Belt with Push Button	<b>Red</b>
SB-N2PM	Seat Belt with Push Button	<b>Maroon</b>



Retractable with 12 " Sleeve & 7" Boot

SB-R2PB	Seat Belt with Push Button	<b>Black</b>
SB-R2PG	Seat Belt with Push Button	<b>Grey</b>
SB-R2PT	Seat Belt with Push Button	<b>Tan</b>
SB-R2PN	Seat Belt with Push Button	<b>Navy Blue</b>
SB-R2PR	Seat Belt with Push Button	<b>Red</b>
SB-R2PM	Seat Belt with Push Button	<b>Maroon</b>



SB-90BR

SB-20FLP	20" Webbing Chrome Push Buckle Black. (Chevy Pu Bench Seat)	<b>Black</b>
SB-90BR	90 Degree End Bracket	



**Seat Belts with Lift Latch:  
10 colors to choose from**



60 Inch Belts

SB-N2LB	Seat Belt with Lift Latch	<b>Black</b>
SB-N2LG	Seat Belt with Lift Latch	<b>Grey</b>
SB-N2LM	Seat Belt with Lift Latch	<b>Maroon</b>
SB-N2LN	Seat Belt with Lift Latch	<b>Navy Blue</b>
SB-N2LR	Seat Belt with Lift Latch	<b>Red</b>
SB-N2LT	Seat Belt with Lift Latch	<b>Tan</b>

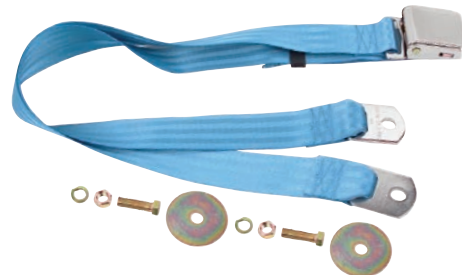

Retractable with 12 " Sleeve & 7" Boot

SB-R2LB	Seat Belt with Lift Latch	<b>Black</b>
SB-R2LG	Seat Belt with Lift Latch	<b>Grey</b>
SB-R2LM	Seat Belt with Lift Latch	<b>Maroon</b>
SB-R2LN	Seat Belt with Lift Latch	<b>Navy Blue</b>
SB-R2LR	Seat Belt with Lift Latch	<b>Red</b>
SB-R2LT	Seat Belt with Lift Latch	<b>Tan</b>

### 3 Points Retractable Shoulder Belt



SB-R3LB	Retractable 3 Point Seat Belt with Chrome Latch	<b>Black</b>
SB-R3PB	Retractable 3 Point Seat Belt with Push Button	<b>Black</b>
SB-R3PG	Retractable 3 Point Seat Belt with Push Button	<b>Gery</b>
SB-R3PT	Retractable 3 Point Seat Belt with Push Button	<b>Tan</b>
SB-R3PN	Retractable 3 Point Seat Belt with Push Button	<b>Navy Blue</b>
SB-R3PR	Retractable 3 Point Seat Belt with Push Button	<b>Red</b>



## Magnum Alloy Wheels

### CAPS or CAPT

Magnum Alloy Wheel Cap w/ Decal, Short Style or Tall Style  
(Fits FW & GW Series Wheels)



### GW157P NEW

Magnum Alloy Wheel 15"x7" New Design w/ Center Cap,  
4" Backspace *Improved Tooling & Finish*

#### 4.3/4" Bolt Pattern

Tall-Style  
Wheel Cap  
included with  
all 15" Rims



### GW158P NEW

Magnum Alloy Wheel 15"x8" New Design w/ Cap,  
4." Backspace

#### 4.3/4" Bolt Pattern

Tall-Style  
Wheel Cap  
included with  
all 15" Rims



# IMPALA

## Interior Electrical

**M1013C**  
1958-63 Headlamp Switch



**M1013**  
1964-67 Headlamp Switch

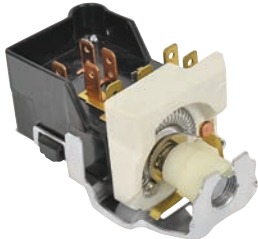

**M1013B**  
1969-84 Headlamp Switch

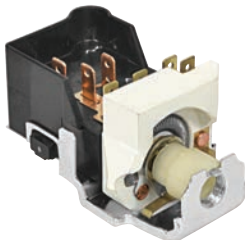

**LH01**  
1962-72 Headlamp Dimmer Switch



**1702P**  
1959-63 Windshield Wiper Switch,  
2 Speed w/ Washer



**LH40**  
1959-63 Windshield Wiper Switch



**1702Q**  
1965-66 Windshield Wiper Switch,  
2 Speed w/ Washer



**1463JM**  
1960-68 Power Window Motor, RH,

**1463KM**  
1960-68 Power Window Motor, LH,



**7031884**  
1967 Cigarette Lighter



**L1700**  
1962-66 Quarter Light Assembly,  
2 Per Car



**L1703**  
1958-67 Dome Light Lens  
1958-61 & 1967- 2 Door, 1958-67- 4 Door



**L1701**  
1962-66 Dome Light Lens, 2 Per Car





## Interior Electrical

**8732777**  
1971-81 Dome Light Lens



**PYU720 NEW**  
1977-79 Power Door Lock Switch



**GME45 NEW**  
1970-72 Temperature Sending Switch



**20030351**  
1971-81 Dome Light Base



**1010U**  
1958-79 Horn Set w/ Universal Brackets, 6 Pcs.



**1010HC**  
1958-72 Horn High + Low Note Chrome Plate  
w/ Mounting Bracket & Hardware



**GF1085 NEW**  
1969-83 Ignition Switch w/o Tilt

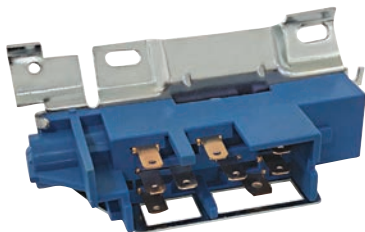

**GF1086 NEW**  
1969-83 Ignition Switch w/ Tilt

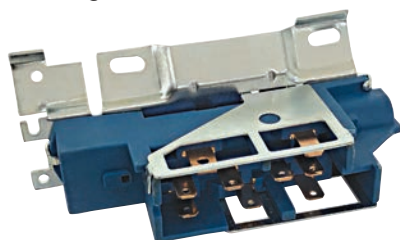

**1010H**  
1958-72 Horn - High  
**1010L**  
1958-72 Horn - Low

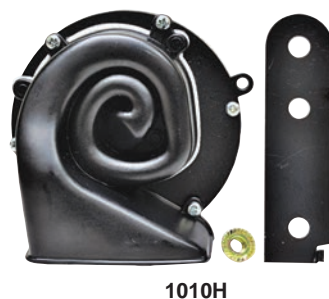

**AM-BT1**  
Digital LCD Battery Monitor,  
12 Volt Cigarette Lighter Plug



# IMPALA

## Decal

**FL01**

1962-68 "Body by Fisher" Decal



## Body Bushing Kits

**M1726K**

1960-64 Body Bushings, 8 Large, 8 Small



**M1728B**

1967-68 Body Bushings w/ Bolts, Hard Top



**M1728E**

1969-70 Body Bushings w/ Bolts, Convertible



**M1728**

1965-66 Body Bushings w/ Bolts, Hard Top



**M1728C**

1967-68 Body Bushings w/ Bolts, Convertible



## Ignition Locks

**161**

1958-64 Original, Octagon Head Key



**M1728A**

1965-66 Body Bushings w/ Bolts, Convertible



**M1728D**

1969-70 Body Bushings w/ Bolts, Hard Top



**157**

1949-64 Octagon Head Key



## Ignition Locks

**158A**  
1965 Original, Octagon Head Key



**158**  
1965 Octagon Head Key



**100**  
1966-67 Later, Square Head Key



**102**  
1969-78 Later, Square Head Key



**457**  
1959-60 Original w/ Long Cyl. & Pawl



**250**  
1961-64 Original w/ Flat Pawl



**100A**  
1966-67 Original, Octagon Head Key

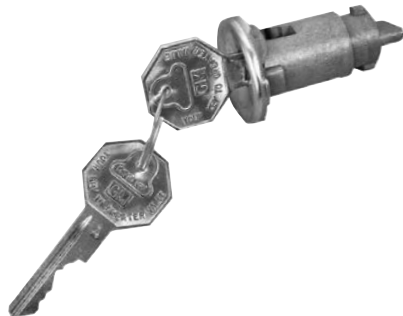

## Ignition & Door Locks

**160A**  
1958, 1961-64 Original w/ Long Cyl.



**143A**  
1965 Original

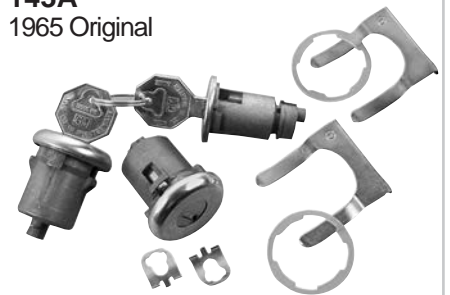

# IMPALA

## Ignition & Door Locks

**104A**  
1966-67 Octagon Head Key



**219**  
1971-76 Later

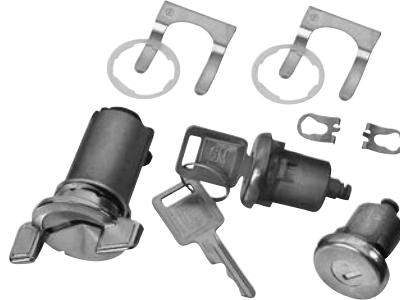

**112**  
1953-94 Later, Round Head Key  
(Excluding 1959)



## Trunk Locks

**104**  
1967-72 Later, Square Head Key



**1575**  
1953-94 Later (Kit w/ Pawl)

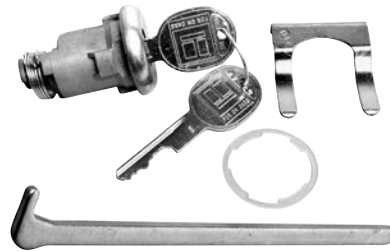

**461**  
1959 Original, Pear Head Key



**106**  
1969-70 Later, Square Head Key

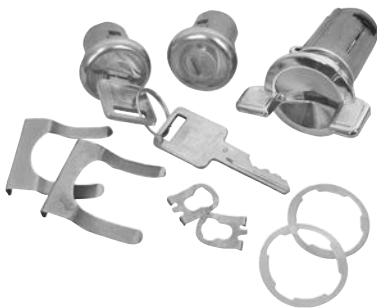

**112AR**  
1953-58 Original w/ Original Ribbed Cap,  
Pear Head Key



**112A**  
1960-68 Original, Pear Head Key





**Ignition, Door, Glove Box  
& Trunk Kits**

**422**  
1958 Original w/ Long Cylinder

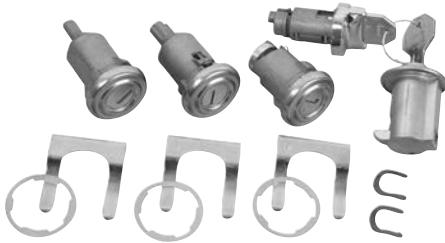

**423**  
1958 Original w/ Short Cylinder



**424**  
1961-62 Original w/ Long Cylinder

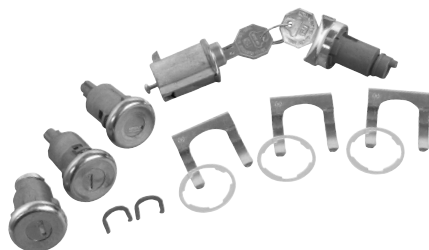

**425**  
1961-62 Original w/ Short Cylinder & Pawl

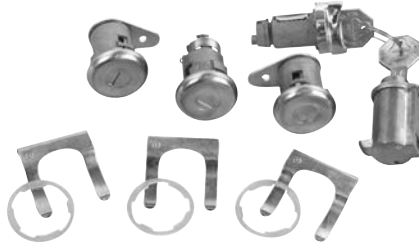

**426**  
1963 Original w/ Long Cylinder

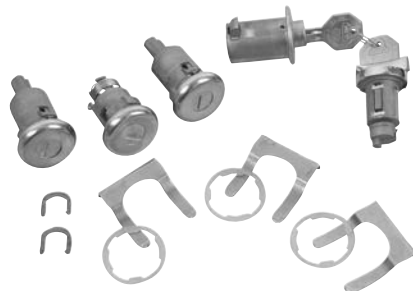

**427**  
1963 Original w/ Short Cylinder & Pawl

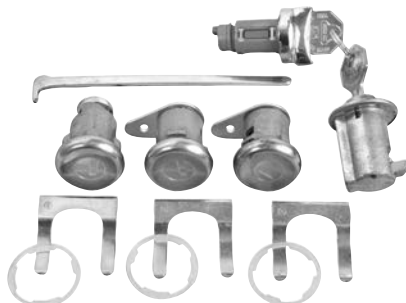

**428**  
1964 Original w/ Long Cylinder

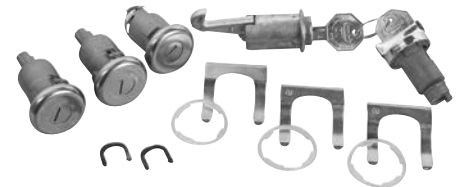

**429**  
1964 Original w/ Short Cylinder & Pawl

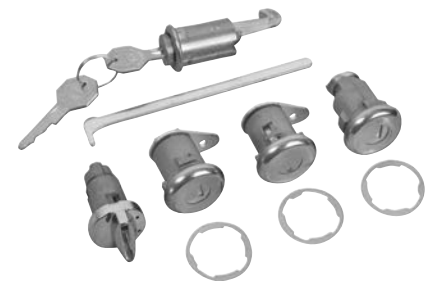

**430**  
1965 Original

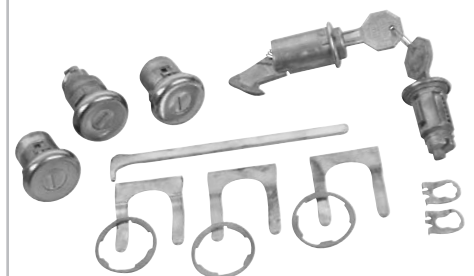

# IMPALA

## Ignition, Door, Glove Box & Trunk Kits

**431**  
1966 Original

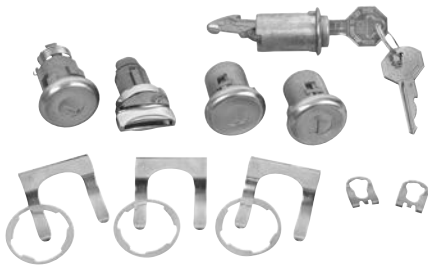

**335**  
1971-76 Later

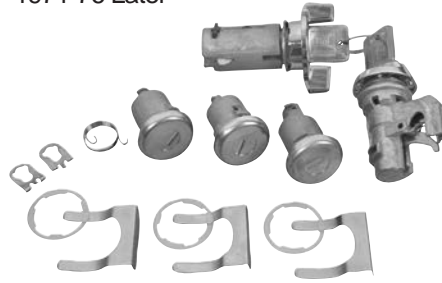

**460**  
1959, 1961-64 Original, Pear Head Key

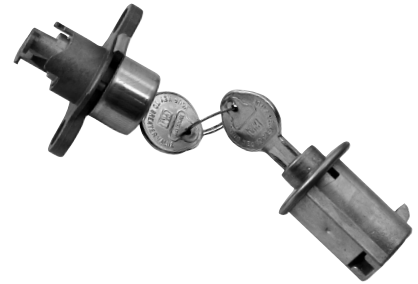

## Glove Box & Trunk Lock Kits

**332**  
1967 Original

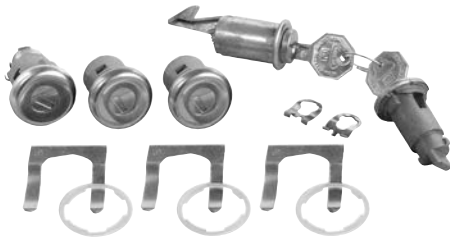

**172A**  
1958-60, 1963 Original,  
Pear Head Key



**171A**  
1961-62 Original, Pear Head Key

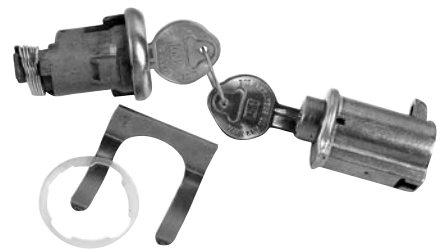

**337**  
1969-70 Later

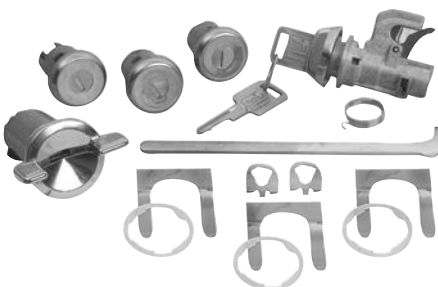

**172**  
1958-60, 1963 Later, Round Head Key

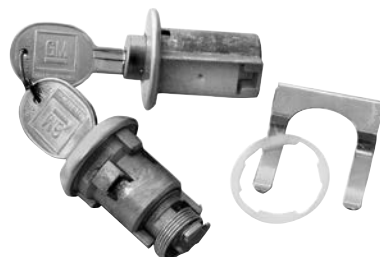

**171**  
1961-62 Later, Round Head Key





## Glove Box & Trunk Lock Kits

**121A**  
1964 Original, Pear Head Key



**121**  
1964 Later, Round Head Key

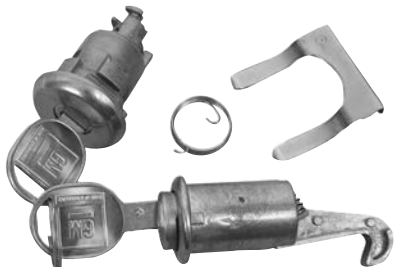

**174**  
1965 Later, Round Head Key



**175**  
1967 Later, Round Head Key



**150A**  
1968 Original, Pear Head Key



**150**  
1968-76 Later, Round Head Key



## Glove Box Locks

**CL-955**  
1958-72 Key-less



**CL-960**  
1958-72 Key-Less, Brushed Stainless



**168**  
1961-63 Later, Round Head Key



# IMPALA

## Glove Box Locks

### 169A

1961-62 Original, Pear Head Key



### 165A

1965-66 Original, Pear Head Key



### 119A

1968-76 Original, Pear Head Key



### 169

1961-62 Later, Round Head Key



### 165

1965-66 Late, Round Head Key



### 119

1968-76 Later, Round Head Key



### 118A

1964 Original, Pear Head Key



### 166A

1967 Original, Pear Head Key



### 118

1964 Late, Round Head Key

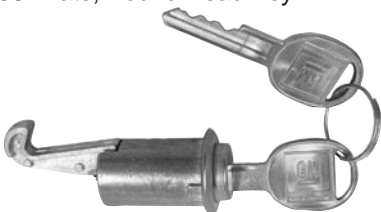

### 166

1967 Later, Round Head Key

