

*Golden Leaf  
Automotive*



**2023  
GTO &  
CUTLASS**

# GTO / Cutlass Index

## A

Accelerator Pedal Assembly: 36  
Air Cleaner Vent Tube: 8  
Antenna Adapter: 33  
Antenna Nut: 32  
Arm Rest, Ash Tray & Pad, Rear: 38  
Arm Rest Bases: 37, 38  
Ash Tray: 11

## B

Battery Trays & Clamp: 4, 5  
Body Mount Trunk Brace: 15  
Body Panel, Rear: 23  
Body Shims & Washers: 3  
Brake Backing Plate, Disc: 48  
Brake & Clutch Pedal Pivot Retainer: 36  
Bridge Plates: 4  
Bucket Seat Release Button: 41  
Bumpers: 1  
Bumper Brackets: 2  
Bumper Filler: 2  
Bushings: 47

## C

Cigarette Lighter: 44  
Clothes Hanger Hooks: 39  
Console Shift Indicator Assy: 36  
Control Arm: 5  
Convertible Top Components: 17  
Convertible Top Frame Holder: 17  
Convertible Top Latch Assembly: 17  
Convertible Top Latch Hooks & Knuckles: 17  
Convertible Top Well Moldings: 32  
Cowl Panels: 9  
Cowl Seals: 2  
Crossrail, Rear: 23

## D

Dash Bezel: 10  
Dash Components: 9, 10, 11  
Dash Insert: 10  
Dash/Vent Knob & Shaft: 9  
Digital LCD Battery Monitor: 43  
Door Accessories: 20, 21  
Door Bumpers: 39  
Door Glass Assembly: 34  
Door Handle Pad: 21  
Door Handle Push Button Kit: 21  
Door Handle Relay: 21  
Door Handles: 20, 21  
Door Hinge: 19  
Door Jamb Vent Grille: 39  
Door Latch: 19  
Door Lock Knob: 37  
Doors & Hardware: 18, 19, 20

Door Shell: 18  
Door Sill Decal: 47  
Door Sill Scuff Plates: 40  
Door Lock Striker: 19  
Door Sill Scuff Plates: 39  
Door Skins: 18  
Door Trims & Arm Rests: 37, 38, 39  
Drip Rail Molding: 30

## E

Electrical, Exterior: 32  
Electrical, Interior: 43, 44, 45, 46  
Emergency Brake Switch: 36  
Evaporator Box: 35

## F

Fan Shroud: 35  
Fenders, Front: 2, 3  
Fenders, Inner Front: 2  
Firewall Brackets: 9  
Firewalls & Components: 8, 9  
Floor Pan Plug: 14  
Floor Pans & Components: 11, 12, 13, 14  
Floor Pan Support: 14  
Front Aprons: 9  
Front Molding Rocker Extension: 31  
Front Seat Back Spring: 41  
Front Seat Bottom Spring: 41  
Front Valance: 2  
Fuel Senders & Components: 26, 27  
Fuel Sending Unit Gasket: 27  
Fuel Sending Unit Locking Ring: 27  
Fuel Tank Braces: 27  
Fuel Tanks: 25, 26  
Fuel Tank Straps: 27

## G

Glass: 33, 34, 35  
Glove Box: 52  
Grille & Components: 28, 29  
Grille Molding: 29  
Grille Ornament: 28  
Grille Support: 28  
Grille Trim: 29

## H

Header Panel: 2  
Headlamp Bezel: 28  
Headlamp Bucket: 28  
Headlamp Dimmer Switch: 44  
Headlamp Mount Buckets: 28  
Headlamp Retaining Rings: 28  
Headlight Switch: 44  
Headliner Clips: 17  
Heater Box: 35  
Heater & Evaporator Boxes: 35  
Heating/Cooling: 35

Hidden Headlight Switch: 44  
Hood Bumpers: 8  
Hood Hinge: 7, 8  
Hood Hinge Spring: 8  
Hood Latch Assembly: 8  
Hoods & Components: 6, 7, 8  
Hood Scoop: 6  
Hood Scoop Inserts: 6  
Horn Adapter: 37  
Horn Cap Assy.: 37  
Horn Relay: 45  
Horns: 46

## I

Ign. & Door Lock Kits: 51  
Ign., Door & Trunk Kits: 49  
Ignition Locks: 48, 49  
Ignition Switch: 45  
Ignition Switch Bezel Nut: 10  
Ignition Switch Bracket: 10  
Interior Hooks: 39

## L

License Plate Bracket: 25  
License Plate Frames: 25  
License Plate Lamps: 32  
Lighter & Lights Bezels: 10  
Locks: 48, 49  
Lower Radiator Saddle: 4

## M

Magnum Alloy Wheels: 43  
Mirrors, Exterior: 27  
Mirrors, Interior: 39

## N

Nose Panel: 2

## O

Oil Sending Switch: 44

## P

Park Brake Release Handle: 36  
Parking Brake Assembly: 36  
Pedal & Shifter Components: 36  
Power Antenna Adapter: 33  
Power Antenna Switch Kit: 33  
Power Window Motor: 44

## Q

Quarter / Door Frame Assemblies: 16  
Quarter Panels: 21, 22  
Quarter Panel Skin: 22  
Quarter Window Assembly: 35  
Quarter Window Glass: 35

## R

Radiator Bridge Plates: 4  
Radiator Support Bushings: 47  
Radiator Supports: 4  
Ram Air Vent Tube: 37  
Rear Deck Panels & Crossrails: 23, 24  
Rear Filler Panel: 24  
Rear Molding Deck Lid: 29  
Rear Molding Rocker Extension: 31  
Rear Panel: 31  
Rear Seat Floor Pan: 14  
Rear View Mirror: 39  
Reveal Moldings: 30  
Reverb Plate: 33  
Rocker Panel Molding: 30, 31  
Rocker Panels: 14  
Roof Panel & Brackets: 16, 17

## S

Scuff Plates: 39, 40  
Seat Assembly: 40  
Seat Belts: 42  
Seat Floor Pan: 14  
Seats & Components: 40, 41  
Seat Side Support Spring: 41  
Seat Springs: 41  
Seat Track Assembly: 41  
Shoulder Harness Hooks: 39  
Speedometer Cable Grommet: 9  
Sport Wood Steering Wheel Switch: 37  
Sport Wood Wheel Collar: 36  
Sport Wood Wheel Switch Adapter: 37  
Steering Wheels & Components: 36,  
37  
Sun Visor Support Bracket: 39

## T

Tail Lamp Lenses: 32  
Tank Braces/Straps: 27  
Trunk Floor Brace: 15  
Trunk Floor Drop Off: 15  
Trunk Floor Patch Panel: 15  
Trunk & Glove Box Kits: 49, 50  
Trunk Kits: 53  
Trunk Lid: 24  
Trunk Lid Extension Moldings: 31  
Trunk Lid Latch: 24  
Trunk Lid Molding: 31  
Trunk Light Kit: 46  
Trunk Locks: 53  
Trunk Pans & Components: 15  
Turn Signal Switch: 45

## V

Valance, Front: 2  
Valance Molding: 30  
Vent Window Assembly: 35  
Vent Window Crank: 20  
Vent Window Glass: 34  
Vent Window Handle: 20

## W

Wheelhouses: 23  
Wheel Opening Moldings: 32  
Window Crank: 20  
Window Moldings, Rear: 31  
Window Regulator: 19, 20  
Windshield Channels: 5  
Windshield Glass: 33, 34  
Windshield Moldings: 29  
Windshield Washer Nozzle: 6  
Windshield Wiper Switch: 43  
Wiper Motor Transmission Arm: 29



General Motors Trademarks  
are used under License to  
Dynacorn International Inc.

# GTO & CUTLASS

## Bumpers

**1570**

1966-67 Front Bumper, Premium Quality



**1571A**

1967 Rear Bumper, Premium Quality



**1571B**

1966 Rear Bumper, Premium Quality



**1571**

1967 Tempest, Rear Bumper, Premium Quality



**1572**

1968-69 Front Bumper, "Endura"



**1571D**

1968 Rear Bumper, Premium Quality



**1573**

1970-72 Rear Bumper, Premium Quality



**1860**

1970 Cutlass, Front Bumper, Premium Quality



**1862**

1970 Cutlass, Rear Bumper, Premium Quality



**1861**

1971-72 Cutlass, Rear Bumper, Premium Quality



(NOT a 442; has no cut outs for exhaust)

## Bumper Brackets

### 1570A

1966-67 Front Bumper Brackets, 4 Pcs.



### 1571E

1966 Rear Bumper Brackets, 3 Pcs.



## Bumper Filler

### 1529A

1967 Front Bumper Filler Panels, 7 Pcs.



## Header Panel

### 1527A

1966 Header Panel



## Front Valance

### 1529

1969 Front Valance



## Nose Panel

### 1527

1967 Nose Panel



## Front Fenders

### 1504R

1966-67 Front Inner Fender, RH

### 1504L

1966-67 Front Inner Fender, LH



### 1502

1968-69 Front Inner Fender, RH

### 1503

1968-69 Front Inner Fender, LH



### RPF163 *NEW*

1964-67 Inner Fender to Cowl Seals, Pair



# GTO & CUTLASS

## Front Fenders

### 1501C

1966 Front Fender, RH

### 1501D

1966 Front Fender, LH



### 1501A

1967 Front Fender w/ HL Buckets, RH

### 1501B

1967 Front Fender w/ HL Buckets, LH



### 1500

1968-69 Front Fender, RH

### 1501

1968-69 Front Fender, LH



### 1500E

1970 Front Fender, RH

### 1500F

1970 Front Fender, LH



## Body Shims & Washers

### 1000E

1965-72 Body Shims, 1.6 mm, 10 Pcs.



### GM03

1966-72 Body Washers, 20 Pcs.



### 1000F

1964-72 Body Shims, 6 mm, 10 Pcs.



### 1000D

1967-72 Body Shims, 3 mm, 10 Pcs.

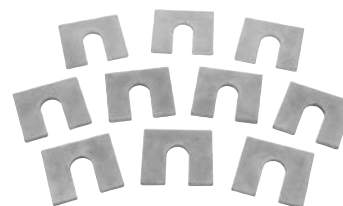

## Radiator Supports

### 1508WT

1966-67 Radiator Support, Weld-Through Primer, w/o A/C, Ram Air or HO Engine



### 1509

1968-70 Radiator Support



### 1875

1970-72 Radiator Support, Cutlass Only



### 1509C

1968-72 Lower Radiator Saddle, w/ Insulator



## Bridge Plates

### 1509A

1968-69 Bridge Plate, Black



### 1509B

1968-69 Bridge Plate, Chrome



## Battery Clamp & Trays

### 1534

1964-67 Battery Tray



### 1535

1968-72 Battery Tray



*Battery Clamp & Trays continued on next page*

# GTO & CUTLASS

## Battery Clamp & Trays

### 1047E

1968-72 Battery Tray Clamp



### 1047EC

1968-72 Battery Tray Clamp, Stainless



## Control Arms

### 1495MD

1964-72 Upper Control Arm, (Tubular Style), RH, w/ Drop  
Use 1495MD w/ 1495PD

### 1495ND

1964-72 Upper Control Arm, (Tubular Style), LH, w/ Drop  
Use 1495ND w/ 1495QD

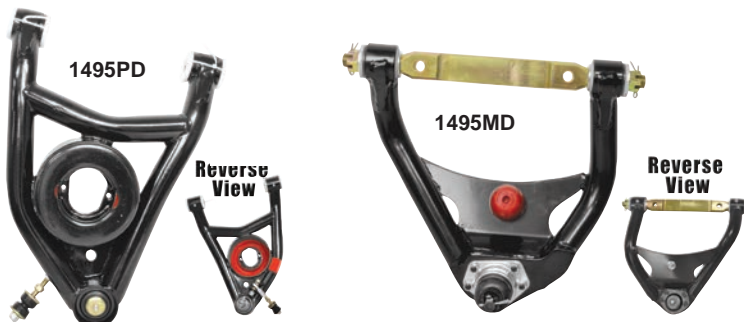

### 1495D

1964-72 Upper Rear Control Arm,  
(A Body) Pair



### 1495PD

1964-72 Lower Control Arm, (Tubular Style) RH w/ Drop  
Use 1495PD w/ 1495MD

### 1495QD

1964-72 Lower Control Arm, (Tubular Style) LH w/ Drop  
Use 1495QD w/ 1495ND



## Windshield Channels

### 1490DWT

1964-67 Windshield Channel,  
Weld-Through Primer



### M1424BWT

1968-72 Windshield Channel,  
Weld-Through Primer





## Windshield Washer Nozzle

### 1507J **NEW**

1964-67 Windshield Washer Nozzle,  
Long



### 1507K **NEW**

1964-67 Windshield Washer Nozzle,  
Short



## Hoods & Components

### 1530

1965-67 Hood Scoop Insert



### 1509Y

1964 Hood Scoop, Chrome, Pair  
**DYNACORN EXCLUSIVE!**



### 1531

1968-70 Hood Scoop Insert, Pair



### 1509X

1964 GTO, Hood

**DYNACORN EXCLUSIVE!**



Hood Shown With 1509Y (Not Included)

### 1510

1965-67 Hood (Also Fits Tempest & Le Mans)



*Hoods continued on next page*

# GTO & CUTLASS

## Hoods & Components

**1512**

1965-67 Hood w/ Scoop



**1511NV**

1968-70 Hood w/ Scoop, No Rear Cowl Vents



**1511**

1968-70 Hood (Except Ram Air)

**DYNACORN EXCLUSIVE!**



**1701A**

1964-67 Hood Hinge, RH,  
(Fits GTO & Cutlass)

**1701B**

1964-67 Hood Hinge, LH,  
(Fits GTO & Cutlass)



**1520**

1968-72 Hood Hinge, RH

**1521**

1968-72 Hood Hinge, LH



## Hoods & Components

### BH30

1964-67 Billet Hood Hinge, Pair



### Heavy-Duty Struts

### 1468F

1964-66 Hood Bumpers, 2 Pcs. Set



### 1069AY

1964-67 Hood Hinge Spring



### 1518

1965-67 Hood Latch Assembly

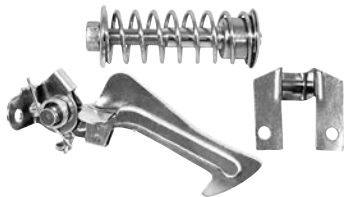

### 1519

1968-70 Hood Latch Assembly

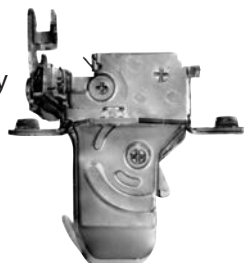

## Air Cleaner Vent Tube

### PYE52 *NEW*

1968-74 Air Cleaner Vent Tube w/o Ram Air



## Firewalls & Components

### 1507D

1964-67 Firewall w/ Heater



### 1507E

1964-67 Firewall, Heater Delete



### 1507A

1968-69 Firewall, Heater Delete



*Firewalls continued on next page*

# GTO & CUTLASS

## Firewalls & Components

**1507B**  
1968-69 Firewall w/ A/C



**1507C**  
1968-69 Firewall w/ Heater



**1509F**  
1968-72 Firewall Brackets, Pair, EDP Coating



## Front Aprons

**1529B**  
1968 Front Lower Apron



## Cowl Panel

**1419A**  
1968-69 Lower Cowl Panel, EDP Coating



## Dash Components

**1403C**  
1964-72 Speedometer Cable Grommet



**PY173S NEW**  
1964-65 Dash/Vent Knob & Shaft

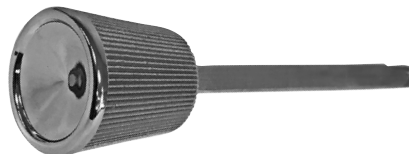

**PY174S NEW**  
1966 Dash/Vent Knob & Shaft



**PY172S NEW**  
1967-72 Dash/Vent Knob & Shaft



## Dash Components

**PY172 NEW**  
1967-72 Dash/Vent Bezel



**LH01G NEW**  
1966-67 Ignition Switch Bezel Nut

Reverse View



**RPI725 NEW**  
1967-68 Dash Bezel Set, 5 Pcs.



**PY171 NEW**  
1969-72 Lighter & Light Bezels



**RPI725W NEW**  
1969-72 Dash Bezel Set, 5 Pcs.



**1516**  
1968 Ignition Switch Bracket



**PY172L NEW**  
1967-72 Lighter

Reverse View



**PY170 NEW**  
1969 Dash Insert Set, 4 Pcs.



# GTO & CUTLASS

## Dash Components

### PY1355A **NEW**

1966-67 Ash Tray



#### Reverse View



### PY1355C **NEW**

1969 Ash Tray



#### Reverse View



### PY1355B **NEW**

1968 Ash Tray



#### Reverse View



### PY1355D **NEW**

1970-72 Ash Tray



#### Reverse View



### PY1350 **NEW**

1968-72 Ash Tray Bracket



#### Reverse View



## Floor Pans & Components

### 1462J

1964-67 Floor Pan Full, RH

### 1462K

1964-67 Floor Pan Full, LH

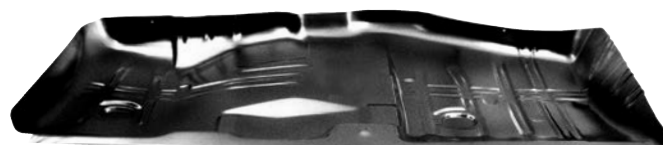

1462J

## Floor Pans & Components

**1462WWT**  
1964-67 "A" Body Full Floor Pan w/ Rear Seat Pan,  
Weld-Through Primer



**1462**  
1968-72 "A" Body Full Floor Pan

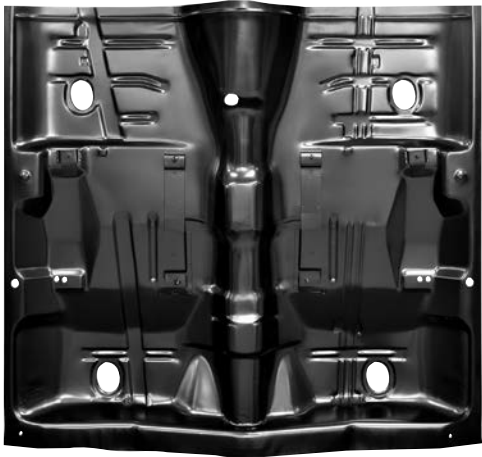

**Underside View**

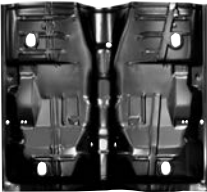

**1462WA**  
1964-67 "A" Body Full Floor Pan W/ Rear Seat Pan,  
Braces & Inner Rockers



**1462Z**  
1968-72 "A" Body Full Floor Pan w/ Rear Seat Pan



*Floor Pans continued on next page*

# GTO & CUTLASS

## Floor Pans & Components

### 1462X

1968-69 "A" Body Complete Floor Pan w/o Rocker Panels  
Includes Front, Center & Rear Under Floor Pan Supports,  
& Rear Seat Floor Pan.

**DYNACORN EXCLUSIVE!**



### 1462YA

1970-72 "A" Body Complete Floor Pan w/ Rocker Panels  
Includes Front, Center & Rear Under Floor Pan Supports,  
Rear Seat Floor Pan And Rocker Panels.



### 1462Y

1968-69 "A" Body Complete Floor Pan w/ Rocker Panels  
Includes Front, Center & Rear Under Floor Pan Supports,  
Rear Seat Floor Pan And Rocker Panels.



### 1462XA

1970-72 "A" Body Complete Floor Pan w/o Rocker Panels  
Includes Front, Center & Rear Under Floor Pan Supports,  
& Rear Seat Floor Pan.



Sales: 866.640.1324

[info@goldenleafautomotive.com](mailto:info@goldenleafautomotive.com)



## Floor Pans & Components

**1047F**

1964-72 Galvanized Floor Pan Plug



**1461Y**

1964-69 Under Floor Pan Support, Front



**1461Z**

1964-69 Under Floor Pan Support, Center



**1461ZA**

1964-67 Under Floor Pan Support, Rear



**1461X**

1968-72 Under Floor Pan Support, Rear



**1461YA**

1970-72 Under Floor Pan Support, Front



**1461ZB**

1970-72 Under Floor Pan Support, Center



## R.Seat Floor Pan

**1462L**

1968-72 Seat Floor Pan, Rear, Coupe

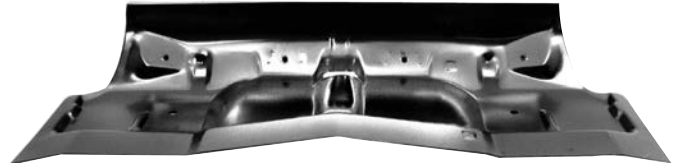

## Rocker Panels

**1489**

1968-72 Outer Rocker Panel, RH

**1489A**

1968-72 Outer Rocker Panel, LH



1489

# GTO & CUTLASS

## Trunk Pans & Components

### 1584WT

1964-67 Complete Trunk Floor Pan, Weld-Through Primer



### 1586

1968-70 Complete Trunk Floor Pan  
(Trim to Fit 1969-70 at Tail Lamp)



### 1489F

1968-72 Trunk Floor Brace RH

### 1489G

1968-72 Trunk Floor Brace, LH



### 1462F

1968-72 Trunk Floor Patch Panel  
for "A" Body, LH



### 1462E

1968-72 Trunk Floor Patch Panel for "A"  
Body, Center



### 1462D

1968-72 Trunk Floor Patch Panel  
for "A" Body, RH



### 1489HWT

1964-67 Body Mount Trunk Brace,  
Weld-Through Primer, RH

### 1489JWT

1964-67 Body Mount Trunk Brace,  
Weld-Through Primer, LH



### 1584AWT

1966-67 Trunk Floor Drop Off,  
Weld-Through Primer, RH

### 1584BWT

1966-67 Trunk Floor Drop Off,  
Weld-Through Primer, LH



### 1584RWT

1968-69 Trunk Floor Drop Off,  
Weld-Through Primer, RH

### 1584LWT

1968-69 Trunk Floor Drop Off,  
Weld-Through Primer, LH



## Quarter / Door Frame Assemblies

**1594**

1968-69 Quarter / Door Assembly, RH

**1595**

1968-69 Quarter / Door Assembly, LH

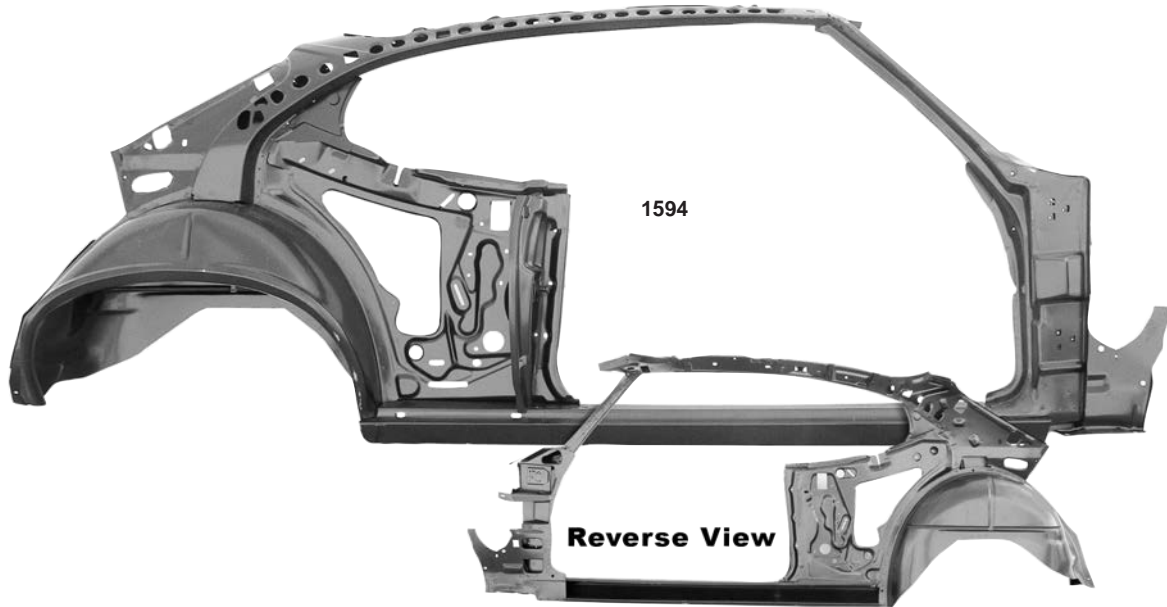

## Roof Panel & Brackets

**1417X**

1966-67 Roof Panel



**1418**

1968-72 Roof Panel



# GTO & CUTLASS

## Roof Panel & Brackets

**1569**

1968-72 Headliner Retainer Kit, 14 Pc. Kit

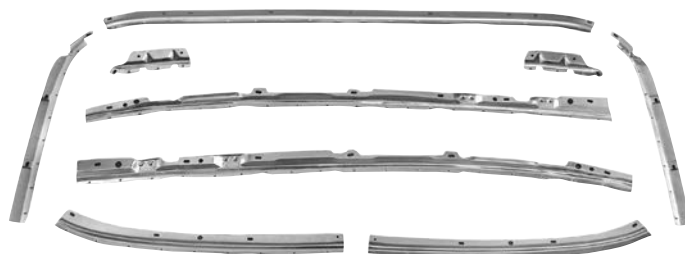
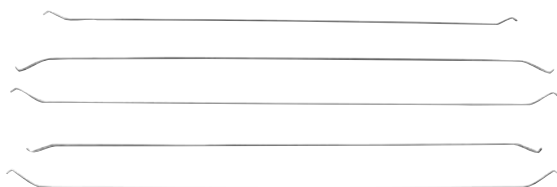

## Headliner Clips

**M1418M**

1968-72 Headliner Clips, 6 Pcs. / Kit, Large



## Convertible Top Components

**1003**

1968-72 Convertible  
Top Latch Hooks & Knuckles



**1539B** *COMING SOON!*

1964-72 Convertible Top Pads



**1538**

1968-72 Convertible  
Top Latch Assembly, Pair



**1539A**

1968-72 Convertible Top Frame Holder, Chrome



**1417Y**

1968-72 Convertible Top Frame Assembly



## Doors & Hardware

**1554R**  
1966-67 Door Shell, RH

**1554L**  
1966-67 Door Shell, LH



1554R

**1554RS**  
1966-67 Door Skin, RH

**1554LS**  
1966-67 Door Skin, LH

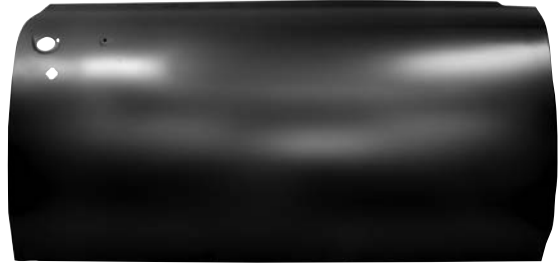

1554RS

**1555R**  
1968 Door Shell, RH

**1555L**  
1968 Door Shell, LH



1555R

**1550**  
1968 Door Skin, RH

**1551**  
1968 Door Skin, LH

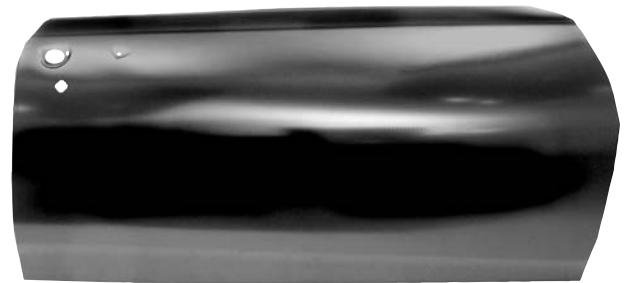

1550

**1556R**  
1969 Door Shell, RH

**1556L**  
1969 Door Shell, LH

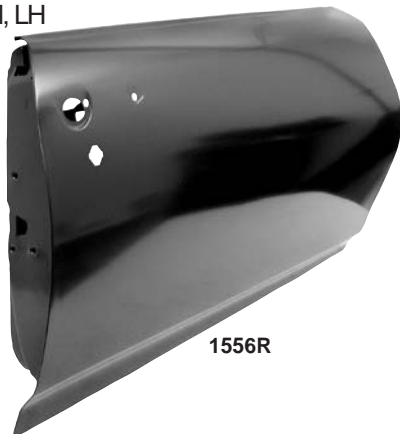

1556R

**1552**  
1969 Door Skin, RH

**1553**  
1969 Door Skin, LH



1552

# GTO & CUTLASS

## Doors & Hardware

### 1556W

1966-67 Door Hinge, Lower, RH

### 1556X

1966-67 Door Hinge, Lower, LH



1556W

### 1556Y

1966-67 Door Hinge, Upper, RH

### 1556Z

1966-67 Door Hinge, Upper, LH



1556Y

### 1556U

1968-72 Door Hinge, Upper, RH=LH

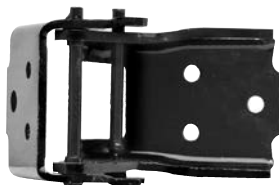

### 1556S

1968-72 Door Hinge, Lower, RH

### 1556T

1968-72 Door Hinge, Lower, LH



1556S

### 1542

1966-67 Door Latch Assembly, RH

### 1543

1966-67 Door Latch Assembly, LH

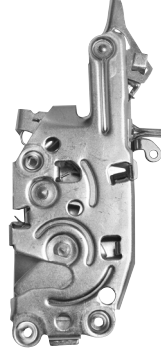

1542

### 1540

1968-69 Door Latch Assembly, RH

### 1541

1968-69 Door Latch Assembly, LH

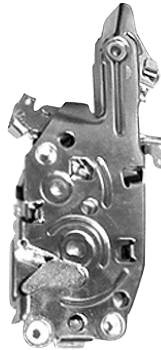

1540

### CH128

1970-72 Chevelle, 1970 Cutlass  
Door Latch Assembly, RH

### CH127

1970-72 Chevelle, 1970 Cutlass  
Door Latch Assembly, LH



CH128

### 1076FE

1965-72 Door Lock Striker



### 1547R

1964-67 Window Regulator, Manual, RH

### 1547L

1964-67 Window Regulator, Manual, LH

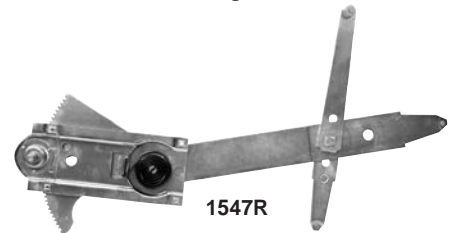

1547R

### 1548R

1968 Window Regulator, Manual, RH

### 1548L

1968 Window Regulator, Manual, LH

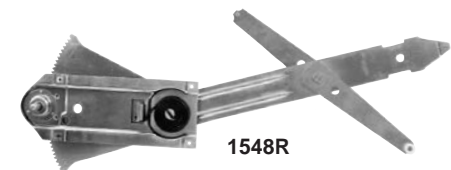

1548R

### 1463

1969 Window Regulator, Manual, RH

### 1463A

1969 Window Regulator, Manual, LH

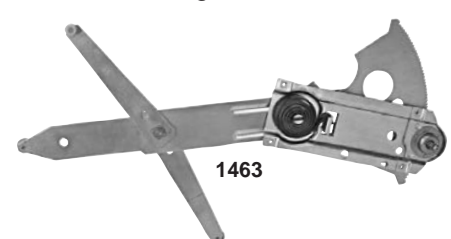

1463

## Doors & Hardware

### 1463D

1970-72 Window Regulator, Manual, RH

### 1463E

1970-72 Window Regulator, Manual, LH

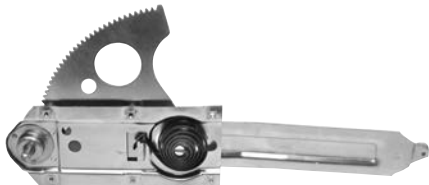

1463E

### 1549R

1968 Quarter Window Regulator, Manual, RH

### 1549L

1968 Quarter Window Regulator, Manual, LH

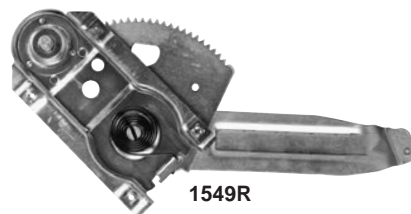

1549R

## Door Accessories

### M1382

1965-66 Window Crank, Chrome Knob



### M1382A

1967 Window Crank, Black Knob



### M1037A

1969-72 Window Crank, Black Knob



### M1037B

1969-72 Window Crank, Clear Knob



### M1392J

1968-72 Vent Window Crank, Clear Knob



### M1392K

1968-72 Vent Window Crank, Black Knob



### M1392I

1966-67 Vent Window Handle, Chrome



### M1390WB

1964-67 Exterior Door Handles w/ Buttons



### M1390

1964-67 Exterior Door Handles w/o Buttons



### M1392

1968-69 Exterior Door Handles w/o Buttons, Pair



### M1037F

1965-67 Interior Door Handle, Standard



### M1037D

1968-72 Interior Door Handle, RH, Standard

### M1037E

1968-72 Interior Door Handle, LH, Standard



M1037D

# GTO & CUTLASS

## Door Accessories

### M1604

1964 Double Arm Interior Door Handle



### M1605

1964 Single Arm Interior Door Handle



### 1076FG

1968-69 Door Handle Relay, RH

### 1076FH

1968-69 Door Handle Relay, LH



### M1037C

1966-67 Door Handle Push Button, Pair



### GFD20A *NEW*

1973 Door Handle Pad



## Quarter Panels

### 1589A

1964-65 Quarter Panel, RH, Coupe

### 1589B

1964-65 Quarter Panel, LH, Coupe



### 1589C

1964-65 Quarter Panel, RH, Convertible

### 1589D

1964-65 Quarter Panel, LH, Convertible



### 1590R *NEW*

1966 Full Quarter Panel, RH, Coupe

*DYNACORN EXCLUSIVE!*

### 1590L *NEW*

1966 Full Quarter Panel, LH, Coupe

*DYNACORN EXCLUSIVE!*





## Quarter Panels

### 1591R

1967 Full Quarter Panel, RH

**DYNACORN EXCLUSIVE!**

### 1591L

1967 Full Quarter Panel, LH

**DYNACORN EXCLUSIVE!**



### 1590C

1970-72 Quarter Panel Skin, RH

### 1590D

1970-72 Quarter Panel Skin, LH



### 1593RWT

1968-69 Full Quarter Panel, RH, Weld-Through Primer

### 1593LWT

1968-69 Full Quarter Panel, LH, Weld-Through Primer



### 1590E COMING SOON!

1966 Quarter Panel, Full, RH, Convertible

**DYNACORN EXCLUSIVE!**

### 1590F COMING SOON!

1966 Quarter Panel, Full, LH, Convertible

**DYNACORN EXCLUSIVE!**



### 1590A

1966-67 Quarter Panel Skin, RH

### 1590B

1966-67 Quarter Panel Skin, LH



### 1590G NEW

1967 Quarter Panel, Full, RH, Convertible

**DYNACORN EXCLUSIVE!**

### 1590H NEW

1967 Quarter Panel, Full, LH, Convertible

**DYNACORN EXCLUSIVE!**



# GTO & CUTLASS

## Wheelhouses

### 1506CWT

1964-67 Inner Wheelhouse,  
Weld-Through Primer, RH

### 1506DWT

1964-67 Inner Wheelhouse,  
Weld-Through Primer, LH



1506CWT

### 1506RWT

1964-67 Outer Wheelhouse,  
EDP Coating, RH

### 1506LWT

1964-67 Outer Wheelhouse,  
EDP Coating, LH



1506RWT

### 1506AWT

1964-67 Complete Wheelhouse  
(Inner & Outer), Weld-Through Primer, RH

### 1506BWT

1964-67 Complete Wheelhouse  
(Inner & Outer), Weld-Through Primer, LH



1506AWT

### 1472W

1968-72 Inner Wheelhouse, RH

### 1472X

1968-72 Inner Wheelhouse, LH



1472W

### 1506W

1968-69 Outer Wheelhouse, RH

### 1506X

1968-69 Outer Wheelhouse, LH



1506W

### 1506S

1968-69 Complete Wheelhouse  
(Inner & Outer), RH

### 1506T

1968-69 Complete Wheelhouse  
(Inner & Outer), LH



1506S

## Rear Deck Panels

### 1544

1965 Rear Crossrail



### 1544B

1968-69 Rear Crossrail / Under Rear Deck Filler



### 1583AWT

1968 Rear Body Panel, Weld-Through Primer



## Rear Deck Panels

### 1545B *NEW*

1966-67 Deck Filler Panel, Convertible

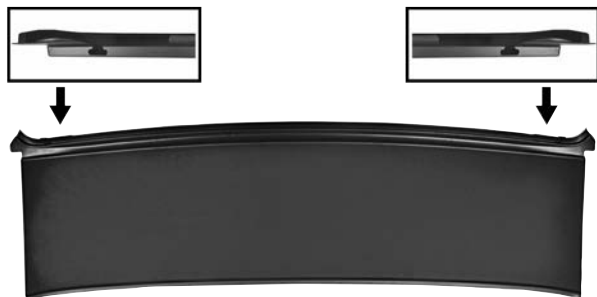

### 1545

1966-67 Rear Deck Filler Panel, Coupe



### 1546

1968-72 Rear Deck Filler Panel, Coupe



## Trunk Lid Latch

### M1019A

1973-74 Trunk Lid Latch



## Trunk Lid

### 1588

1968 Trunk Lid



### 1588A

1969 Trunk Lid w/o Flat Spot Holes



### 1870

1970-72 Cutlass, Trunk Lid, Exc. Supreme



# GTO & CUTLASS

## Lic. Plate Bracket

**1424B**  
1964-72 License Plate Holder Bracket



**PYF24 NEW**  
1965 Front License Bracket



**PYF23 NEW**  
1970 Front License Bracket



## License Plate Frames

**LF64**  
1964 License Plate Frames

**LF71**  
1971 License Plate Frames

**LF72**  
1972 License Plate Frames

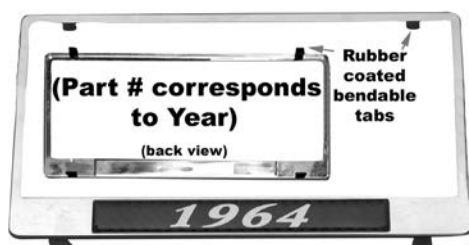

WHILE SUPPLIES LAST!

**T75**  
1965-67 Fuel Tank w/ Neck ( No Vent )



## Fuel Tanks

**T74**  
1964 Fuel Tank w/ Neck  
( No Vent )



**T76**  
1968-70 Fuel Tank w/ 2 Vent Pipes ( No Neck )

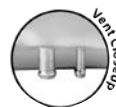
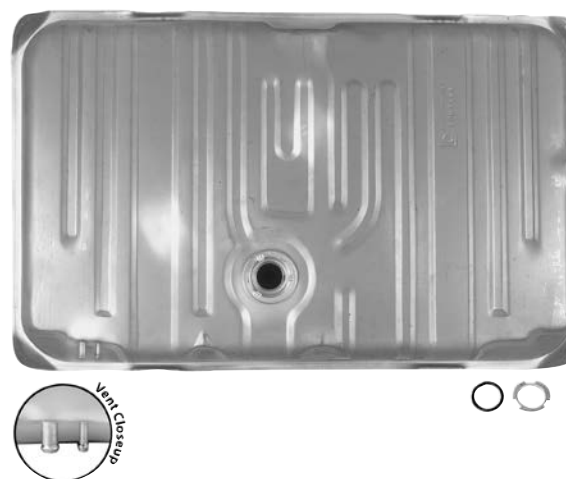

## Fuel Tanks

### T77

1969-70 Fuel Tank w/ 14" Neck & Vent Pipe

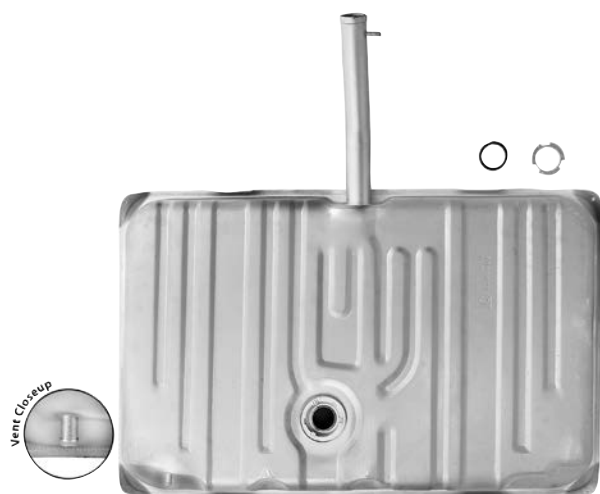

### T79

1971-72 Fuel Tank w/ 15" Neck & 3 Vent Pipes

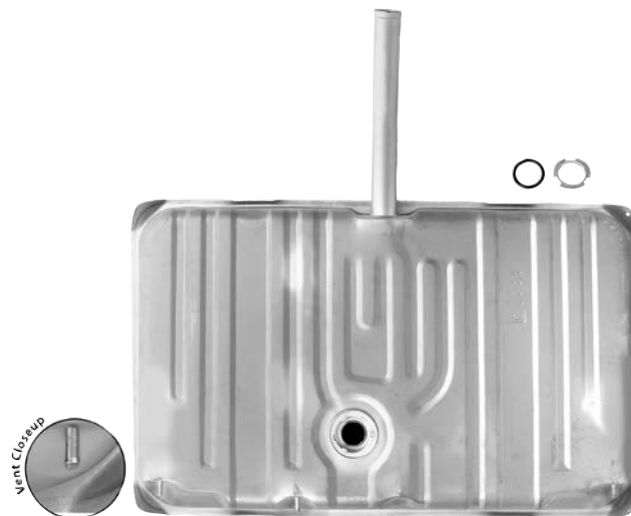

### T78

1970 Fuel Tank w/ 14" Neck & 3 Vent Pipes



### T30B

1976-77 Cutlass, Fuel Tank, 19 Gal.



## Fuel Senders & Components

### T70

1964 Fuel Sender, Fits All Motors



### T72

1968-70 Fuel Sender, For V-8 w/ A/C



### T73

1970 Fuel Sender, For V-8 w/ A/C



# GTO & CUTLASS

## Fuel Senders & Components

**T20**  
1964-72 Fuel Sending Unit Locking Ring



**T21**  
1964-72 Fuel Sending Unit Gasket



## Exterior Mirrors

**1580**  
1964-66 Exterior Mirror (Door Mounted)



**1581**  
1967-68 Exterior Mirror



**1582**  
1969-72 Exterior Mirror



**1583 COMING SOON!**  
1965-68 Mirror Outside, LH, Remote



## Tank Braces/Straps

**1587**  
1966-67 Fuel Tank Mount Brace



**1489K**  
1968-72 Fuel Tank Mount Brace



**1462P**  
1971-72 Cutlass, 1968-72 GTO, Fuel Tank Straps, Pair

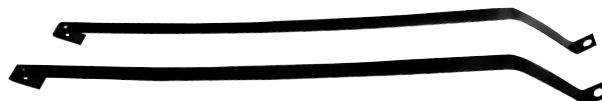

## Grille & Components

**1528**  
1969 Grille, Set of 2



**M1527**  
1969 Grille Ornament



**1509E**  
1968 Grille Support



**LH60**  
1970 Cutlass, Headlamp Bucket, RH

**LH61**  
1970 Cutlass, Headlamp Bucket, LH



**LH30**  
1966-70 Headlamp Mount Buckets w/ Rings, 8 Pcs.



**PYF80 NEW**  
1969 Headlamp Bezel, Pair

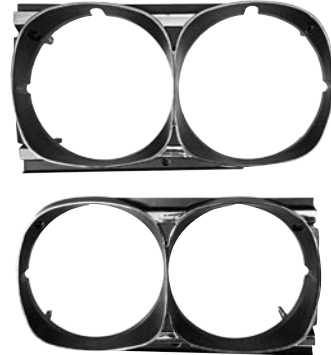

**LH31**  
1967-70 Headlamp Retaining Rings, 4 Pcs.



# GTO & CUTLASS

## Grille & Components

### 1527C *NEW*

1966 Grille Trim, Pair



### 1527B *NEW*

1967 Grille Molding



## Wiper Trans. Arm

### 1507G

1968-69 Wiper Motor Transmission Arm



## Rear Molding Deck Lid

### M1532

1966 Rear Molding Deck Lid, Center w/ 6 Clips



## Windshield Moldings

### M1422

1964-65 Windshield Moldings, 5 Pcs



### M1423

1966-67 Windshield Moldings, 5 Pcs



### M1424

1968-72 Windshield Moldings, 3 Pcs



### M1424A

1968-72 Windshield Molding, Lower, Coupe/Convertible





## Drip Rail Molding

### M1500

1964-65 Drip Rail Moldings, 6 Pcs.



### M1348

1966-67 Drip Rail Moldings, 2 Pcs.



### M1501

1968-72 Drip Rail Moldings, 6 Pcs.



## Reveal Moldings

### M1540

1966-67 Front Door Ledge Reveal Moldings, Convertible



### M1541

1966-67 Quarter Ledge Reveal Moldings, Convertible



## Valance Molding

### RPF10M *NEW*

1968 Valance Molding, Pair



## Rocker Panel Molding

### M1510

1964-65 Rocker Molding, No Clips, RH

### M1511

1964-65 Rocker Molding, No Clips, LH



M1510

### M1514

1967 Rocker Molding, RH (Also Fits 1967 Le Mans)

### M1515

1967 Rocker Molding, LH (Also Fits 1967 Le Mans)



M1514

### M1512

1970-72 Rocker Molding, RH

### M1513

1970-72 Rocker Molding, LH



M1512

# GTO & CUTLASS

## Rocker Panel Molding

### M1516A **NEW**

1966 Rear Molding Rocker Extension, Pair



### M1516

1966 Front Molding Rocker Extension, Pair



#### Hardware Close-up



## Rear Window Moldings

### M1424Y

1964-65 Rear Window Moldings, 5 pcs.  
(Buick, Olds & Pontiac Hard Tops)



### M1425

1966-67 Rear Window Moldings, 4 Pcs.



## Vinyl Top Molding

### RPR45 **NEW**

1968-69 Vinyl Top Molding, Pair

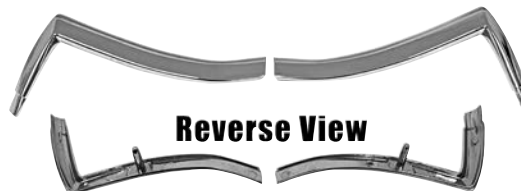

#### Reverse View

## Trunk Lid Mldg.

### M1533 **NEW**

1966 Trunk Lid Extension Moldings, Pair, w/ 8 Nuts



#### Accessory Close-Up



### M1531

1967 Trunk Lid Extension Moldings

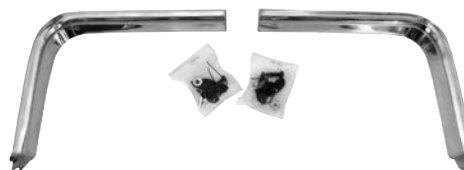

### M1530

1967 Trunk Lid Molding



## Rear Panel

### 1598 **NEW**

1965 GTO/Le Mans, Rear Panel, Chrome



## Wheel Opening Moldings

### M1560

1964-65 Wheel Opening Moldings, 4 Pcs.



### M1562

1968-69 Wheel Opening Moldings w/ Mounting Screws, 4 Pcs.



### M1561

1966-67 Wheel Opening Moldings, 4 Pcs.



### M1563

1970-72 Wheel Opening Moldings, 4 Pcs.



## Convertible Top Well Moldings

### M1550

1966-67 Convertible Top Well Moldings, Tempest Only



### M1551

1966-67 Convertible Top Well Moldings, GTO / Le Mans



## Exterior Electrical

### M1618

1966-72 Rear License Plate Lamp, GTO



### L1009A

1970 Cutlass, License Plate Lamp



### 1596

1969 Tail Lamp Lenses



### PYF54 *NEW*

1964-69 Antenna Nut



**Reverse View**

# GTO & CUTLASS

## Exterior Electrical

### PYF50 **NEW**

1964 Antenna Adapter, Manual



**Reverse View**

### PYR12A **NEW**

1966-67 Power Antenna Adapter



**Reverse View**

### PYI20 **NEW**

1966-67 Power Antenna Switch Kit



### PYF51 **NEW**

1965 Antenna Adapter, Manual



**Reverse View**

### PYR12 **NEW**

1968-69 Power Antenna Adapter



**Reverse View**

### PYI10 **COMING SOON!**

1964-65 Reverb Chrome Plate w/ Handle



### PYR10 **NEW**

1964-65 Power Antenna Adapter

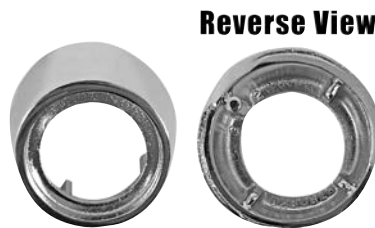

**Reverse View**

### PYI18 **NEW**

1964-65 Power Antenna Switch Kit



### PYI12 **NEW**

1966-67 Reverb Plate w/ Handle



## Glass

### 1400PA

1966-67 Windshield Glass, Coupe / Convertible, Clear



Clear Glass

### 1400PD

1966-67 Windshield Glass, Coupe / Convertible, Green Tinted

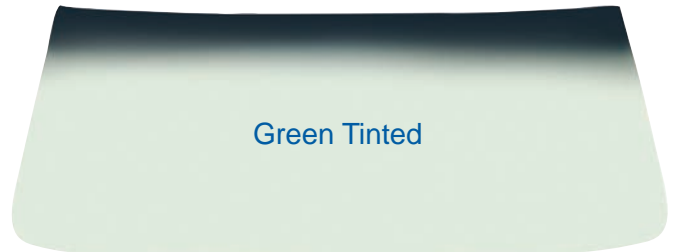

Green Tinted

## Glass

### 1400PC

1968-72 Windshield Glass, Green Tinted

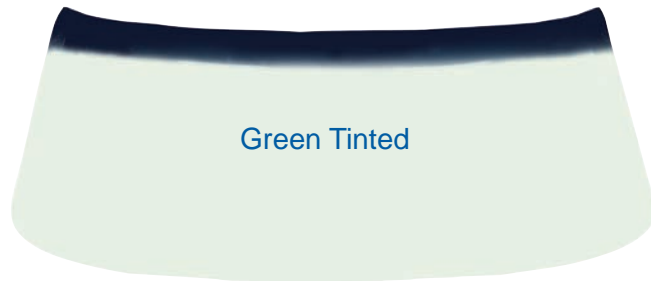

### 1555

1966-67 Door Glass Assembly, RH, Clear, Coupe / Convertible

### 1556

1966-67 Door Glass Assembly, LH, Clear, Coupe / Convertible



### 1485TB

1968 Door Glass Assembly, RH, Clear, Hard Top / Coupe / Convertible

### 1485UB

1968 Door Glass Assembly, LH, Clear, Hard Top / Coupe / Convertible

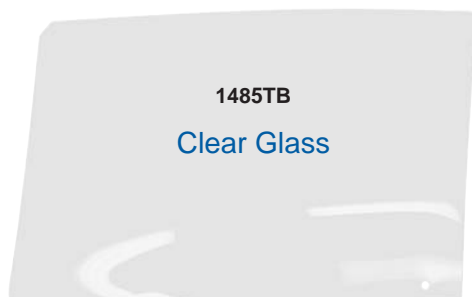

### 1485TC

1969 Door Glass Assembly, RH, Clear, Hard Top / Coupe / Convertible

### 1485UC

1969 Door Glass Assembly, LH, Clear, Hard Top / Coupe / Convertible



### 1485MA

1970-72 Door Glass Assembly, RH, Clear, Hard Top / Convertible

### 1485MB

1970-72 Door Glass Assembly, LH, Clear, Hard Top / Convertible



### 1485JA

1966-67 Vent Window Glass, RH, Clear, Hard Top / Convertible

### 1485JB

1966-67 Vent Window Glass, LH, Clear, Hard Top / Convertible



# GTO & CUTLASS

## Glass

### 1485J

1966-67 Vent Window Assembly, RH, Clear, Hard Top/ Convertible

### 1485K

1966-67 Vent Window Assembly, LH, Clear, Hard Top/ Convertible



### 1485KE

1966-67 Quarter Window Glass, RH, Clear, Hard Top

### 1485KF

1966-67 Quarter Window Glass, LH, Clear, Hard Top



### 1597

1968-72 Quarter Window Glass, RH, Clear, Hard Top

### 1597A

1968-72 Quarter Window Glass, LH, Clear, Hard Top



### 1558

1968-69 Quarter Window Assembly w/ Track, RH, Clear

### 1559

1968-69 Quarter Window Assembly w/ Track, LH, Clear



## Heating/Cooling

### 1536

1966-67 Heater Box - Standard Non-Air

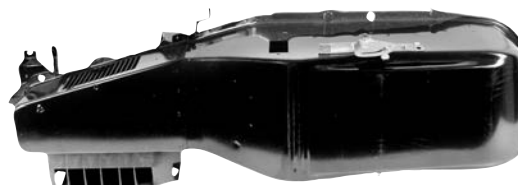

### 1400

1968-72 Evaporator Box



### RPE69 *NEW*

1968 Fan Shroud, Fiberglass



## Pedal & Shifter Components

**1525**  
1965-67 Parking Brake Assembly



**1526**  
1968-72 Parking Brake Assembly



**1499**  
1968-69 Accelerator Pedal Assembly



**1499A**  
1970-72 Accelerator Pedal Assembly



**PYI201K NEW**  
1969-73 Console Shift Indicator Assy.



**PYI100 NEW**  
1964-72 Emergency Brake Switch



**1525A NEW**  
1964-72 Park Brake Release Handle



**1006PC NEW**  
1964-73 Brake & Clutch Pedal Pivot Retainer

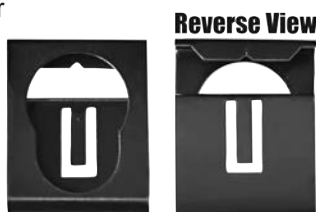

## Steering Wheels & Components

**PYI39C NEW**  
1969-72 Formula Steering Wheel



**PYI38F NEW**  
1971-74 Steering Wheel, Custom Sport



**PYI39CL NEW**  
1969-72 Formula Steering Wheel Collar



TTTTTT

**PYI64 NEW**  
1969-72 Sport Wood Wheel Collar

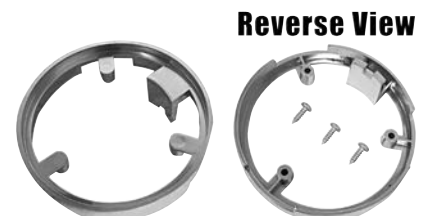

# GTO & CUTLASS

## Steering Wheels & Components

**GMI124 NEW**  
1965-73 Sport Wood  
Steering Wheel Switch



Reverse View

**PYI66 NEW**  
1969-72 Sport Wood Wheel  
Switch Adapter



Reverse View

**RPI47 NEW**  
1967 Horn Cap Assy.



**RPI47A NEW**  
1968 Horn Cap Assy.



**GMI123 NEW**  
1970-72 Horn Adapter,  
Formula Steering Wheel



**PYE50 NEW**  
1969-70 Ram Air Vent Tube



## Door Trims & Arm Rests

**M1770**  
1964-66 Door Lock Knob, Black, Pair



**M1771**  
1964-66 Door Lock Knob, Chrome, Pair



**M1772**  
1967 Door Lock Knob, Black, Pair



**M1773**  
1967 Door Lock Knob, Chrome, Pair



**M1777**  
1968-69 Door Lock Knob, Black, Pair



**M1774**  
1968-69 Door Lock Knob, Chrome, Pair



**M1775**  
1970-72 Door Lock Knob, Chrome, Pair



**M1602**  
1964-67 Arm Rest Bases, Chrome, Pair



**M1715**  
1965-67 Cutlass Arm Rest Bases,  
Chrome, Pair

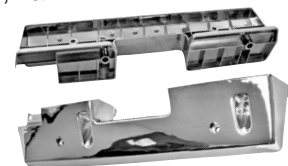



## Door Trims & Arm Rests

### M1040

1968-72 Arm Rest Base, Black, RH, Pair

### M1040A

1968-72 Arm Rest Base, Black, LH, Pair



M1040A

M1040

### M1040B

1968-72 Arm Rest Base, Red, Pair



### M1040C

1968-72 Arm Rest Base, Medium Blue, Pair



### M1040D

1968-72 Arm Rest Base, Ivy Gold, Pair



### M1040E

1968-72 Arm Rest Base, White, Pair



### M1040F

1968-72 Arm Rest Base, Dark Blue, Pair



### M1040G

1968-72 Arm Rest Base, Dark Green, Pair



### M1040L

1966-67 Rear Arm Rest, Ash Tray & Pad, Pair

**DYNACORN EXCLUSIVE!**



### M1040J

1968-69 Rear Arm Rest (No Trim), Ash Tray & Pad, Pair

**DYNACORN EXCLUSIVE!**



### M1040K

1968-72 Rear Arm Rest w/ Chrome Trim, Ash Tray & Pad, Pair



# GTO & CUTLASS

## Door Trims & Arm Rests

### 1485G

1968-72 Door Bumpers,  
2 Pcs. Set



### 1485H

1970-72 Door Jamb Vent Grille



## Int. Mirrors, Visor Brkt.

### 911366

1968 Rear View Mirror 10"



### M1035A

1969-71 Rear View Mirror 12"



### M1338

1964-72 Sun Visor Support Bracket



Now includes  
bushing and  
screws!

## Interior Hooks

### GM01

1966-70 Clothes Hanger Hooks, 2 Pcs. Set



### GM02

1966-70 Shoulder Harness Hooks, 2 Pcs. Set

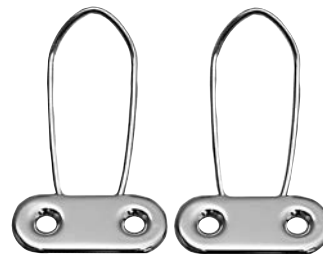

## Scuff Plates

### M1340

1964-67 Scuff Plate w/o Ribs



### M1340A

1964-67 Scuff Plates, Stainless w/o Ribs, Pair



## Scuff Plates

### M1341

1964-67 Scuff Plate w/ Ribs



### M1341A

1964-67 Scuff Plates, Stainless w/ Ribs, Pair



### M1342

1968-72 Scuff Plate, RH

### M1343

1968-72 Scuff Plate, LH



M1342

### M1342A

1968-72 Scuff Plates, Stainless



## Seats & Components

### 1401

1966-68 Seat Frame Assembly, RH

**DYNACORN EXCLUSIVE!**

### 1402

1966-68 Seat Frame Assembly, LH

**DYNACORN EXCLUSIVE!**

### 1402A

1969-72 Seat Frame Assembly, RH=LH

**DYNACORN EXCLUSIVE!**

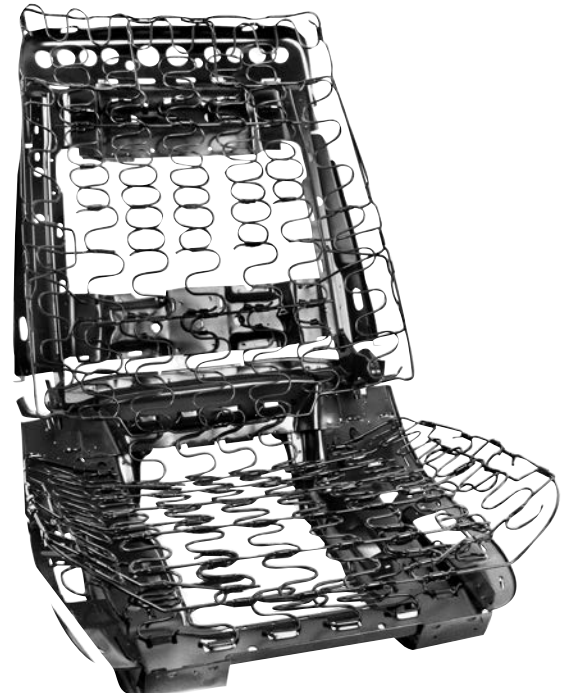
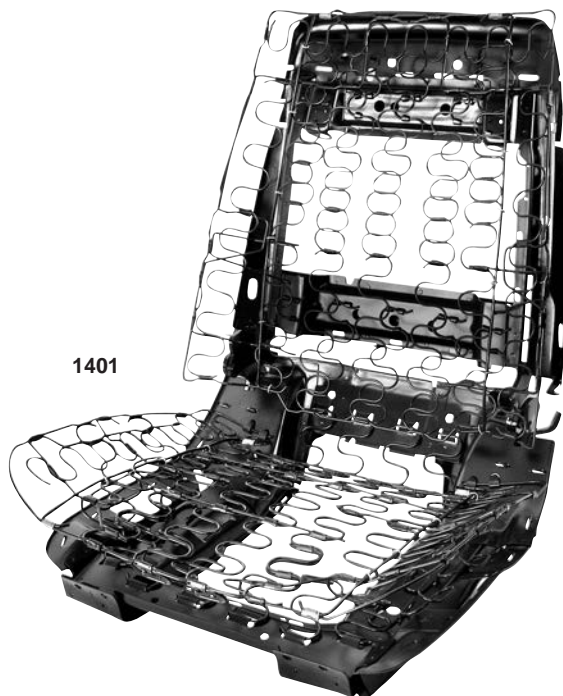

# GTO & CUTLASS

## Seats & Components

**1402L**

1966-72 Front Seat Back Spring, RH=LH

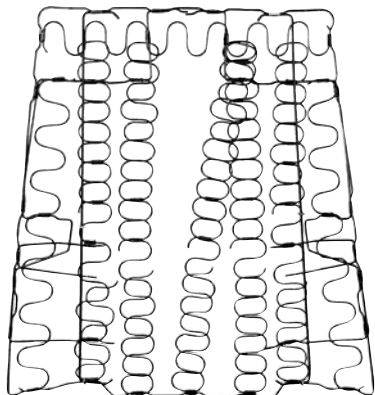

**1402K**

1966-72 Front Seat Bottom Spring, RH=LH

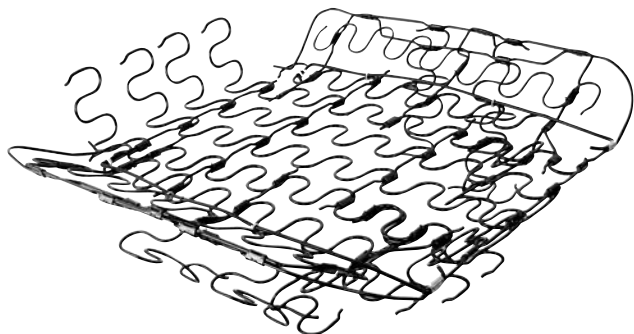

**1402P**

1966-72 Seat Side Support Spring, 4 Pc. + 8 Clips

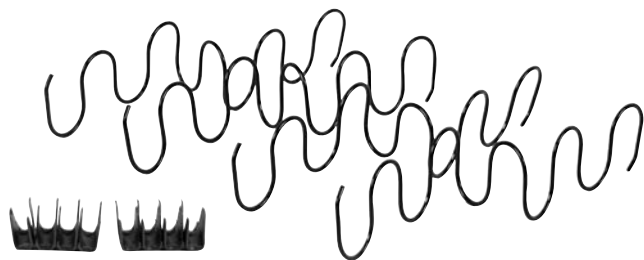

**M1392P**

1967-68 Bucket Seat Release Button



**1560**

1966-72 GTO, 1968-72 Cutlass  
Seat Track Assembly, RH, 2 Pcs.

**1561**

1966-72 GTO, 1968-72 Cutlass  
Seat Track Assembly, LH, 2 Pcs.



1561

## Seat Belts

### Seat Belts with Push Button: 6 colors to choose from

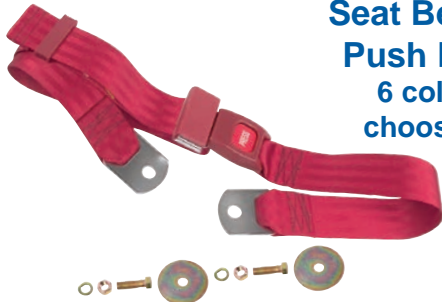

#### 60 Inch Belts

SB-N2PB	Seat Belt with Push Button	<b>Black</b>
SB-N2PG	Seat Belt with Push Button	<b>Grey</b>
SB-N2PT	Seat Belt with Push Button	<b>Tan</b>
SB-N2PN	Seat Belt with Push Button	<b>Navy Blue</b>
SB-N2PR	Seat Belt with Push Button	<b>Red</b>
SB-N2PM	Seat Belt with Push Button	<b>Maroon</b>



#### Retractable with 12 " Sleeve & 7" Boot

SB-R2PB	Seat Belt with Push Button	<b>Black</b>
SB-R2PG	Seat Belt with Push Button	<b>Grey</b>
SB-R2PT	Seat Belt with Push Button	<b>Tan</b>
SB-R2PN	Seat Belt with Push Button	<b>Navy Blue</b>
SB-R2PR	Seat Belt with Push Button	<b>Red</b>
SB-R2PM	Seat Belt with Push Button	<b>Maroon</b>



SB-90BR

SB-20FLP	20" Webbing Chrome Push Buckle Black. (Chevy Pu Bench Seat)	<b>Black</b>
SB-90BR	90 Degree End Bracket	

### Seat Belts with Lift Latch: 10 colors to choose from



#### 60 Inch Belts

SB-N2LB	Seat Belt with Lift Latch	<b>Black</b>
SB-N2LG	Seat Belt with Lift Latch	<b>Grey</b>
SB-N2LM	Seat Belt with Lift Latch	<b>Maroon</b>
SB-N2LN	Seat Belt with Lift Latch	<b>Navy Blue</b>
SB-N2LR	Seat Belt with Lift Latch	<b>Red</b>
SB-N2LT	Seat Belt with Lift Latch	<b>Tan</b>

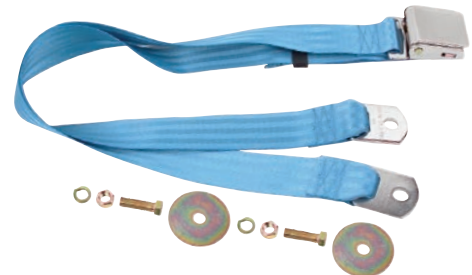

#### Retractable with 12 " Sleeve & 7" Boot

SB-R2LB	Seat Belt with Lift Latch	<b>Black</b>
SB-R2LG	Seat Belt with Lift Latch	<b>Grey</b>
SB-R2LM	Seat Belt with Lift Latch	<b>Maroon</b>
SB-R2LN	Seat Belt with Lift Latch	<b>Navy Blue</b>
SB-R2LR	Seat Belt with Lift Latch	<b>Red</b>
SB-R2LT	Seat Belt with Lift Latch	<b>Tan</b>

### 3 Points Retractable Shoulder Belt



SB-R3LB	Retractable 3 Point Seat Belt with Chrome Latch	<b>Black</b>
SB-R3PB	Retractable 3 Point Seat Belt with Push Button	<b>Black</b>
SB-R3PG	Retractable 3 Point Seat Belt with Push Button	<b>Grey</b>
SB-R3PT	Retractable 3 Point Seat Belt with Push Button	<b>Tan</b>
SB-R3PN	Retractable 3 Point Seat Belt with Push Button	<b>Navy Blue</b>
SB-R3PR	Retractable 3 Point Seat Belt with Push Button	<b>Red</b>

# GTO & CUTLASS

## Magnum Alloy Wheels

### CAPS or CAPT

Magnum Alloy Wheel Cap w/ Decal, Short Style or Tall Style  
(Fits FW & GW Series Wheels)



### GW157P NEW

Magnum Alloy Wheel 15"x7" New Design w/ Center Cap,  
4" Backspace *Improved Tooling & Finish*

### 4.3/4" Bolt Pattern

Tall-Style  
Wheel Cap  
included with  
all 15" Rims



### GW158P NEW

Magnum Alloy Wheel 15"x8" New Design w/ Cap,  
4." Backspace

### 4.3/4" Bolt Pattern

Tall-Style  
Wheel Cap  
included with  
all 15" Rims



## Interior Electrical

### LH40

1964-65 Windshield Wiper Switch,  
(Single Speed w/ Washer)

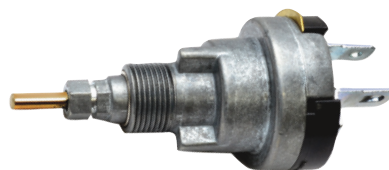

### LH41

1964-66 Windshield Wiper Switch, 2 Speed



### LH48

1967 Windshield Wiper Switch, 2 Speed

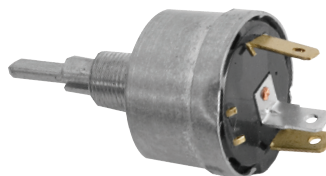

## Interior Electrical

**1463JM**

1965-68 Power Window Motor, RH, Cutlass

**1463KM**

1965-68 Power Window Motor, LH, Cutlass



**LH01**

1966-70 Headlamp Dimmer Switch



**GME41 NEW**

1964-65 Oil Sending Switch



**LH01C NEW**

1968-74 Headlight Switch w/o Parking Light

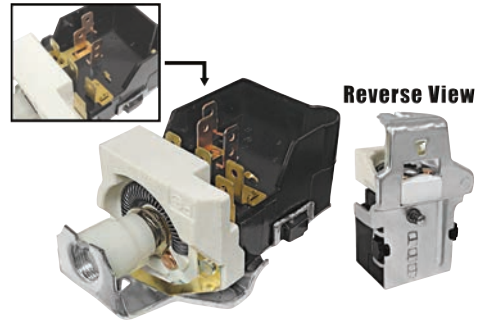

**7033244**

1967-72 Cigarette Lighter



**PY168 NEW**

1968-69 Hidden Headlamp Switch

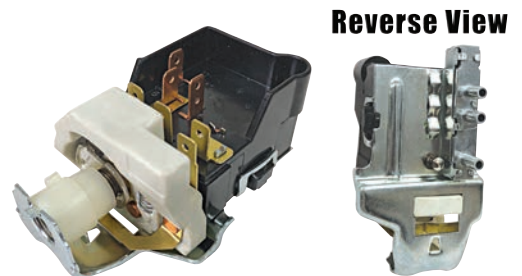

# GTO & CUTLASS

## Interior Electrical

**GME59A NEW**  
1968-71 Horn Relay



**GME59B NEW**  
1972-74 Horn Relay



**GMI311 NEW**  
1969-74 Turn Signal Switch w/o Corner Lamp

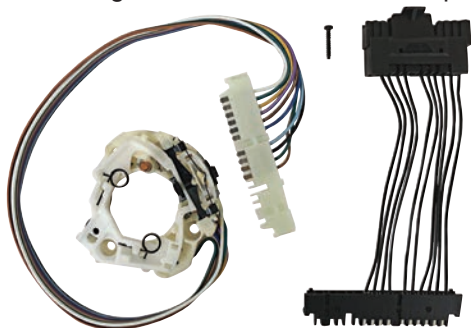

**RPI771 NEW**  
1968 Ignition Switch



**RPI774 NEW**  
1969-70 Ignition Switch w/o Tilt

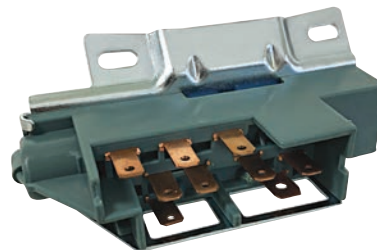

**RPI774T NEW**  
1969-70 Ignition Switch w/ Tilt

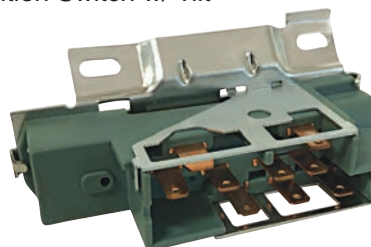

**GF1085 NEW**  
1969-83 Ignition Switch w/o Tilt

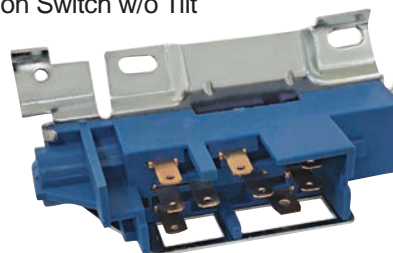

**GF1086 NEW**  
1969-83 Ignition Switch w/ Tilt

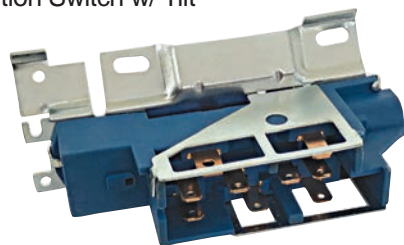



## Interior Electrical

### RPT127 *NEW*

1964-68 Trunk Light Kit



### 1010L

1964-72 Horn-Low Note w/ Mounting Brackets



1010L

### 1010H

1964-72 Horn-High Note w/ Mounting Brackets



1010H

### 1010HC

1964-72 Horn High + Low Note Chrome Plate w/ Mounting Bracket & Hardware



### 1010U

1964-74 Horn Set w/ Universal Brackets, 6 Pcs.



# GTO & CUTLASS

## Door Sill Decal

**FL01**

"Body by Fisher" Decal



## Bushings

**M1450**

1965-67 Radiator Support Bushings



**M1451**

1968-72 Radiator Support Bushings



**M1452**

1964-67 Body Bushings, 10 Pcs., Coupe/Sedan



**M1453**

1968-72 Body Bushings, 12 Pcs., Coupe/Sedan



**M1452A**

1964-67 Body Bushings, 14 Pcs., Convertible



**M1454**

1968-72 Body Bushings, 14 Pcs., Convertible



## Brake Backing Plate

### 1006G

1968-72 Front Disc Brake Backing Plate



## Ignition Locks

### 158

1964-65 Octagon Head Key



### 158A

1964-65 Original, Octagon Head Key



### 100

1966-67 Later, Square Head Key



### 100A

1967 Original, Octagon Head Key



### 101

1968 Later, Square Head Key

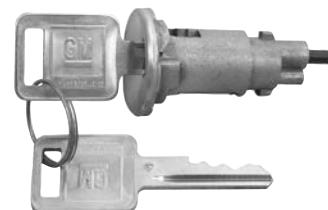

# GTO & CUTLASS

## Ignition Locks

**101A**

1968 Original, Octagon Head Key



**102**

1969-78 Later, Square Head Key



**267**

1963-65 Cutlass, 1964-65 GTO, Original

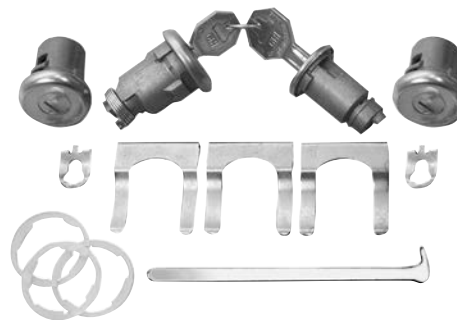

**276**

1966-67 Original

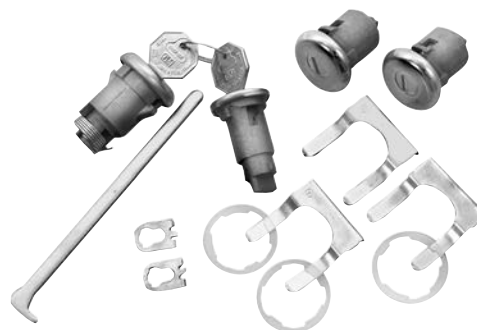

## Ign., Door & Trunk Kits

**269**

1962 Original



## Trunk & Glove Box Kits

**195**

1962 Later



## Trunk & Glove Box Kits

**195A**  
1962 Original

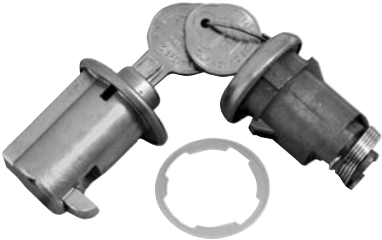

**196**  
1996-67 Later



**172**  
1964-65 Later, Round Head Key

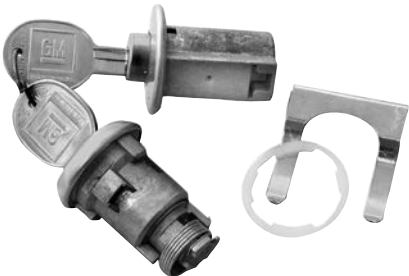

**196A**  
1966-67 Original



**172A**  
1964-65 Original, Pear Head Key

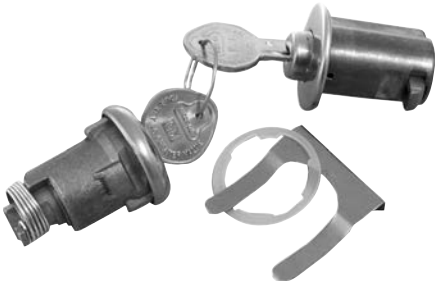

**198**  
1970-75 Later



# GTO & CUTLASS

## Ign. & Door Lock Kits

**143A**

1964-65 Original, Octagon Head Key



**105**

1968 Later, Square Head Key

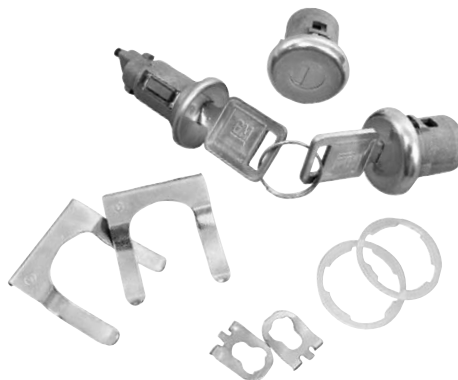

**104**

1966-67 Later, Square Head Key

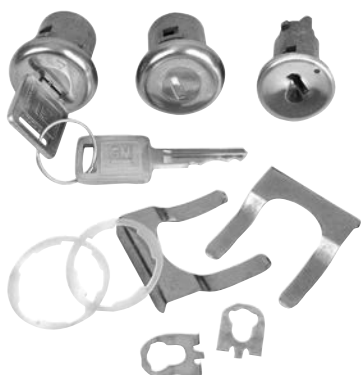

**105A**

1968 Original, Octagon Head Key



**104A**

1966-67 Original, Octagon Head Key



**106**

1969-78 Later, Square Head Key

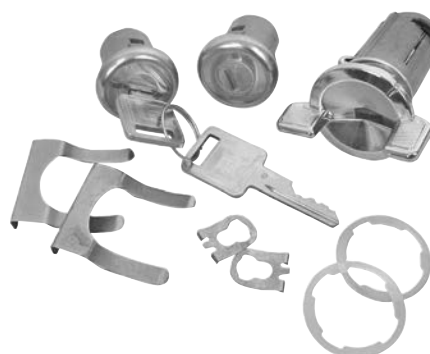

## Glove Box

**CL-955**  
1964-72 Key-less



**169A**  
1964-67 Original, Pear Head Key



**CL-960**  
1964-72 Key-less, Brushed Stainless



**146**  
1968-69 Later, Round Head Key



**169**  
1964-67 Later, Round Head Key

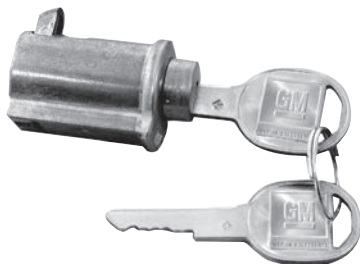

**183**  
1970-75 Later



# GTO & CUTLASS

## Trunk Locks

**112**  
1963-65, 1968-82 Later, Round Head Key



**112A**  
1963-65, 1966-68 Original, Pear Head Key



**113**  
1966-67 Later, Round Head Key



## Trunk Kits

**113A**  
1966-67 Original, Pear Head Key



**1575**  
1964-65, 1968-81 Later, Round Head Key

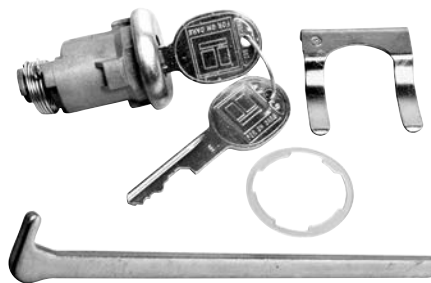

**1576**  
1962, 1966-67 Later, Round Head Key

