

*Golden Leaf  
Automotive*

**FALCON  
FAIRLANE  
RANCHERO**

**2025**



# Falcon / Fairlane/ Ranchero Index

## A

Arm Rest: 14

## B

Battery Trays: 3  
Bed Rail Molding: 14  
Brake Pedal Pad: 13  
Brake Pedal Trim: 14  
Bumpers: 1

## C

Control Arms: 3, 4  
Coolant Filter: 3, 4  
Cowl Cover Panel Upper: 7  
Cowl & Pillar Panels: 7  
Crossmember, Front: 7

## D

Dash Panels & Components: 7  
Decals: 15  
Deck Lid Filler Panel: 11  
Disc Brake Pedal Pad: 13, 14  
Door Handle: 9  
Door Hardware & Accessories: 8, 9, 10  
Door Hinge Bushing: 9  
Door Latch: 9  
Door Locks: 16  
Door Sill Decal: 15  
Door Striker: 10  
Door Striker Set: 10  
Drip Rail Moldings: 14  
Drum Brake Pedal Pad: 13

## E

Export Braces: 5  
Exterior Mirrors: 10

## F

Fender Apron: 6  
Floor Pans & Components: 6, 7  
Front Fenders: 4  
Front Frame Rail: 5  
Front Stone Deflector: 1  
Fuel Sending Unit: 12  
Fuel Tank & Straps: 11, 12

## G

Grille: 1  
Grille Kit: 1  
Grille Trim Kit: 1

## H

Headlamp Switch: 15  
Heater Blower Motor: 12

Heater Box: 13  
Heater Control: 12  
Heater Plenum: 13  
Heater Resistor: 13  
Heating/Cooling Components: 12, 13  
Hood: 6  
Horn Set: 15

## I

Ignition & Door Lock Kits: 16  
Ignition Locks: 15  
Interior Door Handle: 9  
Interior Electrical: 15

## L

Locks: 16  
Lower Control Arm: 4

## M

Mirrors, Exterior: 10

## O

Outer Door Handle: 9

## P

Parking Brake Handle: 13  
Pedal Components: 13, 14

## Q

Quarter Panels: 10

## R

Radiator: 2, 3  
Radiator Support: 2  
Rear Bumper License Plate: 1

## S

Shock Tower Brace Kit: 5  
Shock Tower & Comp: 5, 6  
Spring Saddle: 4  
Steering Wheels: 14  
Stone Deflectors: 1  
Suspension & Steering: 3, 4

## T

Tail Lamp & Components: 11  
Tail Lamp Mounting Rings: 11  
Trunk Pans & Components: 7  
Turn Signal Switch: 7

## U

Upper Control Arm: 3  
Upper Control Arm Shaft Kit: 4

## V

Vent Window Handles: 8

## W

Wheelhouses: 10  
Window Crank Knob Kit: 8  
Windshield Moldings: 14  
Wiper Motor Bracket: 4



Ford Oval and Mustang are registered trademarks owned by Ford Motor Company.

# FALCON / FAIRLANE / RANCHERO

## Bumpers

**3400**

1964-65 **Falcon**, Front Bumper, Chrome

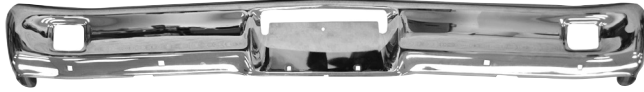

**3900**

1966-67 **Fairlane**, Front Bumper, Chrome



**3901**

1970-71 **Fairlane**, Front Bumper, Chrome



**3904**

1966-67 **Fairlane**, Rear Bumper, Chrome



**3905**

1970-71 **Fairlane**, Rear Bumper, Chrome



**3906**

1966-67 **Fairlane**, Rear Bumper License Plate

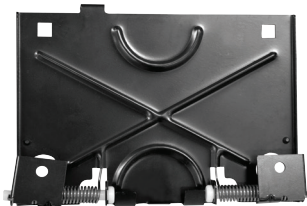

## Stone Deflectors

**3401**

1964-65 **Falcon**, Front Stone Deflector



## Grille

**3910** *COMING SOON!*

1966 **Fairlane**, Grille Assy w/ Trim & Bracket



**3911** *COMING SOON!*

1966 **Fairlane**, Grille Trim Kit, Upper & Lower



**3912**

1956 **Fairlane**, Grille w/ Hardware, 3 Pcs.



**3913**

1955 **Fairlane**, Grille Kit, 5 Pcs.



# FALCON / FAIRLANE / RANCHERO

## Radiator Support

**3415**  
1964-65 Falcon / Ranchero, Radiator Support  
**DYNACORN EXCLUSIVE!**



**3640J NEW**  
1970-71 Fairlane, Radiator Support

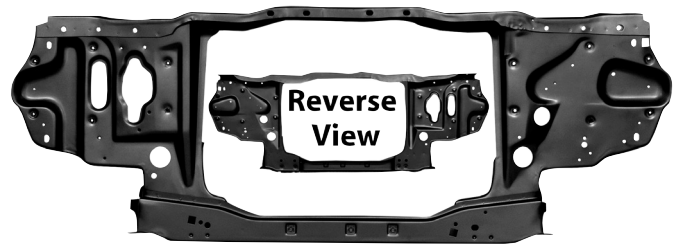

## Radiator

**FM-ER201**  
1963-65 Falcon / Ranchero, Radiator Aluminum 2-row  
V-8, (259)



**FM-ER309**  
1963-65 Falcon, Radiator Aluminum 3-row, (Fox 302),  
(259N)



**FM-ER301**  
1963-65 Falcon / Ranchero, Radiator Aluminum 3-row,  
V-8, (259)



**FM-ER202**  
1963-65 Falcon / Ranchero, Radiator Aluminum 2-row,  
I-6, (251)



# FALCON / FAIRLANE / RANCHERO

## Radiator

### FM-ER209

1964-65 **Falcon**, Radiator Aluminum 2-row, (Fox 302), (259N)



### M3534C

1972-79 **Ranchero**, Battery Tray



## Battery Trays

### M3534B

1963-65 **Falcon**, Battery Tray w/ "J" Bolts,

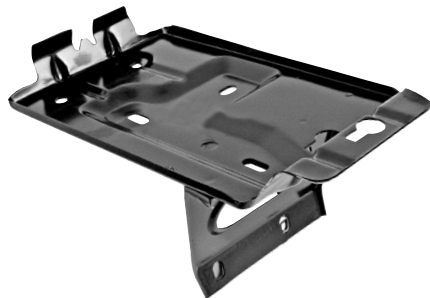

### M3534D

1963-65 **Falcon**, Battery Tray w/ "J" Bolts (Top Clamp Style)



## Suspension & Steering

### 3631HD

1964-65 **Falcon**,  
Upper Control Arm  
w/ Upgraded Rubber Bushings, Heavy Duty Shaft



### 3631J *NEW*

1966-71 **Fairlane**, 67-70 **Falcon**,  
Upper Control Arm



### 3631JL *NEW*

1966-71 **Fairlane**, 67-70 **Falcon**,  
Upper Control Arm w/ Upgraded Rubber  
Bushings, Heavy Duty Shaft



# FALCON / FAIRLANE / RANCHERO

## Suspension & Steering

**3632FHD**

1964-65 Falcon,  
Lower Control Arm w/ HD Reinforce



*Reverse View  
Showing HD  
Reinforcement*

**3631JA NEW**

1966-67 Falcon / Fairlane,  
Lower Control Arm



**3631JD NEW**

1966-70 Falcon, 66-71 Fairlane, Upper Control Arm Shaft Kit



**3631JN NEW**

1966-70 Falcon, 66-71 Fairlane, Upper Control Arm Shaft Kit

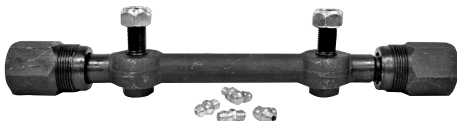

**3631G NEW**

1965-67 Falcon, 66-71 Fairlane, Spring Saddle



**M33885**

1965 Falcon, Wiper Motor Bracket, 1 Speed



## Front Fenders

**3420A**

1964-65 Falcon / Ranchero,  
Front Fender, RH, w/o Molding or Antenna Holes  
**DYNACORN EXCLUSIVE!**

**3421A**

1964-65 Falcon / Ranchero,  
Front Fender, LH, w/o Molding or Antenna Holes  
**DYNACORN EXCLUSIVE!**



# FALCON / FAIRLANE / RANCHERO

## Export Braces

**3635N**

1960-65 Falcon / Ranchero, Export Brace, Painted Black



**3635NC**

1960-65 Falcon / Ranchero, Export Brace, Chrome



## Shock Tower & Components

**3402**

1964-65 Falcon / Ranchero, Shock Tower Assembly, RH  
**DYNACORN EXCLUSIVE!**

**3403**

1964-65 Falcon / Ranchero, Shock Tower Assembly, LH  
**DYNACORN EXCLUSIVE!**



**3402B NEW**

1964-65 Front Frame Rail, RH  
**DYNACORN EXCLUSIVE!**



**3403B NEW**

1964-65 Front Frame Rail, LH  
**DYNACORN EXCLUSIVE!**



**3403A**

1964-65 Falcon / Ranchero, Shock Tower Kit, LH  
**DYNACORN EXCLUSIVE!**



**3402C NEW**

1964-65 Shock Tower Brace Kit, RH  
**DYNACORN EXCLUSIVE!**

**3403C NEW**

1964-65 Shock Tower Brace Kit, LH  
**DYNACORN EXCLUSIVE!**



# FALCON / FAIRLANE / RANCHERO

## Shock Tower & Components

### 3402E NEW

1964-65 Fender Apron, Front / Rear, RH  
**DYNACORN EXCLUSIVE!**

### 3403E NEW

1964-65 Fender Apron, Front / Rear, LH  
**DYNACORN EXCLUSIVE!**



### 3402D NEW

1964-65 Shock Tower Brace, Outer, RH  
**DYNACORN EXCLUSIVE!**

### 3403D NEW

1964-65 Shock Tower Brace, Outer, LH  
**DYNACORN EXCLUSIVE!**



## Hood

### 3410A

1964-65 Falcon / Ranchero, Hood w/o Emblem Holes  
**DYNACORN EXCLUSIVE!**

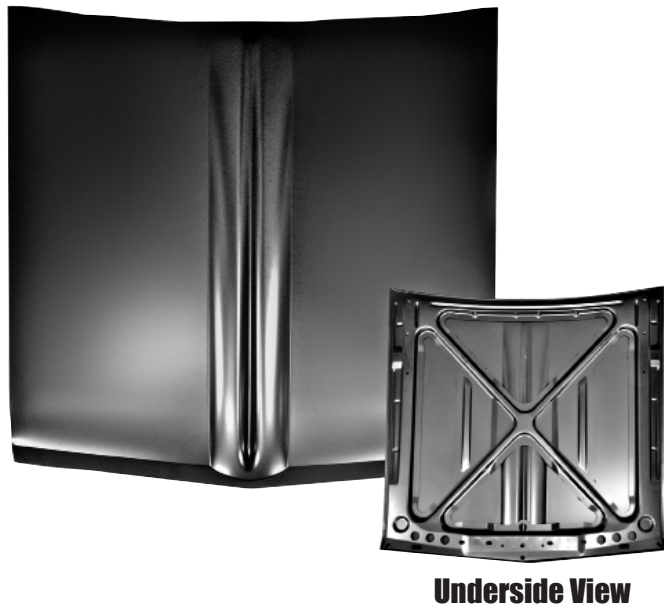

## Floor Pans & Components

### 3430

1964-65 Falcon / Ranchero, Floor Panel Complete,  
**DYNACORN EXCLUSIVE!**

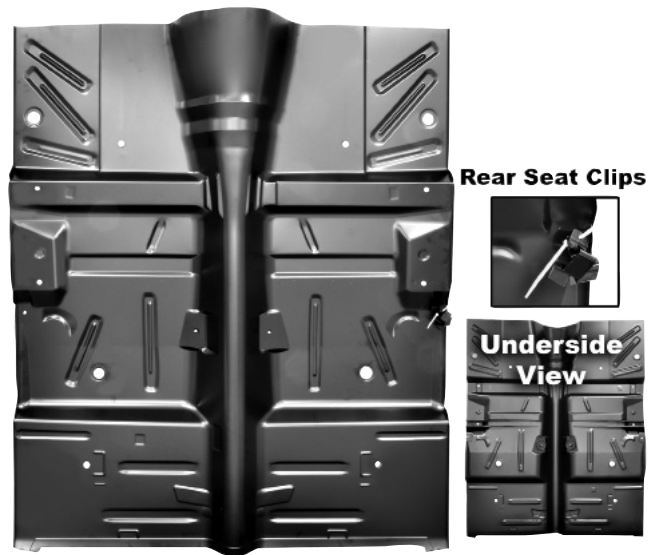



# FALCON / FAIRLANE / RANCHERO

## Floor Pans & Components

### 3648NG **NEW**

1970-71 **Fairlane**, Crossmember, Front, w/ Strut Rod Mounts



### 3601L **NEW**

1970-71 **Fairlane**, Crossmember, (Under Engine)



## Cowl & Pillar Panels

### 3405

1964-65 **Falcon / Ranchero**, Cowl Cover Panel Upper w/ Vents  
**DYNACORN EXCLUSIVE!**



### 3406

1964-65 **Falcon / Ranchero**, Cowl Vent Panel Upper w/o Vents  
**DYNACORN EXCLUSIVE!**



## Dash Panels & Components

### L3071

1965 **Falcon**, Turn Signal Switch w/ Cruise Control

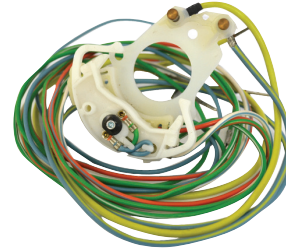

## Trunk Pan Components

### 3450

1964-65 **Falcon**, Trunk Floor Pan Complete  
**DYNACORN EXCLUSIVE!**



**Underside View**

# FALCON / FAIRLANE / RANCHERO

## Door Hardware & Accessories

**3641G**

1964-65 **Falcon**, Vent Window Handle,



**M3529C NEW**

1966-67 **Fairlane / Falcon**, Vent Window Handles



**M3529D NEW**

1968-70 **Falcon**, 68-71 **Fairlane**, Vent Window Handles



**M3528 NEW**

1968-70 **Falcon**, 68-69 **Fairlane / Ranchero**  
Window Crank, w/o Knob



**M3526A**

1964-65 **Falcon**, Window Crank, Early Clip Style



**M3525A NEW**

1968-70 **Falcon**, 68-69 **Fairlane / Ranchero**  
Window Crank Knob Kit, Black, 3 Pcs.



**M3525B NEW**

1968-70 **Falcon**, 68-69 **Fairlane / Ranchero**  
Window Crank Knob Kit, Clear, 3 Pcs.

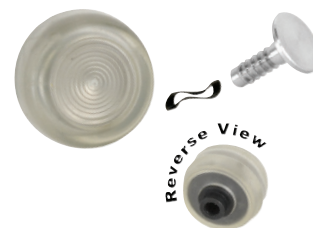

# FALCON / FAIRLANE / RANCHERO

## Door Hardware & Accessories

### M3526

1964-65 **Falcon**, Interior Door Handle, Clip Style, RH=LH



### M3616

1964-65 **Falcon**, Outer Door Handle, Pair



### 3640QB **NEW**

1967-70 **Falcon**, 67-71 **Fairlane**,  
Door Hinge Bushing (2 Per Hinge)



### M3616G

1962-64 **Fairlane**, 64-65 **Falcon**, Door Latch, RH

### M3616H

1962-64 **Fairlane**, 64-65 **Falcon**, Door Latch, LH



M3616G

### M3616C **NEW**

1967-68 **Fairlane / Falcon**, Door Latch, RH

### M3616D **NEW**

1967-68 **Fairlane / Falcon**, Door Latch, LH

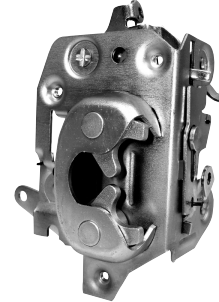

M3616C

### M3616E **NEW**

1969-70 **Fairlane / Falcon**, Door Latch, RH

### M3616F **NEW**

1969-70 **Fairlane / Falcon**, Door Latch, LH



M3616E

### M3616J **NEW**

1971 **Fairlane**, Door Latch, RH

### M3616K **NEW**

1971 **Fairlane**, Door Latch, LH

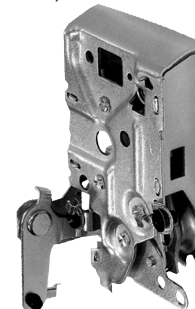

M3616J

# FALCON / FAIRLANE / RANCHERO

## Door Hardware & Accessories

**3641NA**  
1964-65 **Falcon**, Door Striker



**M3546 NEW**  
1966-70 **Falcon**, 66-71 **Fairlane**,  
Door Striker Set, Zinc Plated w/ Shim



## Exterior Mirrors

**M3524B**  
1963-66 **Falcon**, Standard Exterior Mirror



**M3524EC NEW**  
1967-70 **Falcon**, 67-71 **Fairlane**,  
Outside Mirror, Std w/ Convex Glass



**M3524F NEW**  
1967-70 **Falcon**, 67-71 **Fairlane**,  
Outside Mirror Gasket Kit



## Quarter Panels

**3470**  
1964-65 **Falcon**, Quarter Panel, RH, Coupe & Convertible  
**DYNACORN EXCLUSIVE!**

**3471**  
1964-65 **Falcon**, Quarter Panel, LH, Coupe & Convertible  
**DYNACORN EXCLUSIVE!**

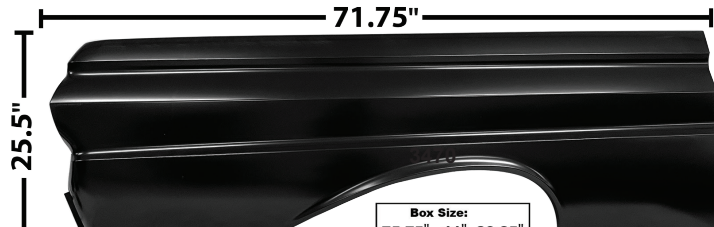

**3472**  
1964-65 **Falcon**, Quarter Panel, RH, Sedan  
**DYNACORN EXCLUSIVE!**

**3473**  
1964-65 **Falcon**, Quarter Panel, LH, Sedan  
**DYNACORN EXCLUSIVE!**



## Wheelhouses

**3480**  
1964-65 **Falcon**, Wheelhouse Inner, RH  
**DYNACORN EXCLUSIVE!**

**3481**  
1964-65 **Falcon**, Wheelhouse Inner, LH  
**DYNACORN EXCLUSIVE!**



**3482**  
1964-65 **Falcon**, Wheelhouse Outer, RH  
**DYNACORN EXCLUSIVE!**

**3483**  
1964-65 **Falcon**, Wheelhouse Outer, LH  
**DYNACORN EXCLUSIVE!**



# FALCON / FAIRLANE / RANCHERO

## Deck Lid Filler Panel

### 3440 **NEW**

1964-65 **Falcon** Deck Lid Filler Panel, Coupe  
**DYNACORN EXCLUSIVE!**



## Tail Lamp & Components

### 3446

1964-65 **Falcon**, Quarter to Tail Lamp Extension, RH  
**DYNACORN EXCLUSIVE!**

### 3447

1964-65 **Falcon**, Quarter to Tail Lamp Extension, LH  
**DYNACORN EXCLUSIVE!**



### 3448

1964-65 **Falcon**, Tail Panel Corner, RH  
**DYNACORN EXCLUSIVE!**

### 3449

1964-65 **Falcon**, Tail Panel Corner, LH  
**DYNACORN EXCLUSIVE!**



### 3444 **COMING SOON!**

1964-65 **Falcon**, Tail Lamp Mounting Rings  
**DYNACORN EXCLUSIVE!**



### 3445

1964-65 **Falcon**, Tail Lamp Panel w/ Tail Lamp Mounting Plates  
**DYNACORN EXCLUSIVE!**



## Fuel Tank & Straps

### T07

1960-65 **Falcon**, Fuel Tank w/ Drain Plug, 16 Gallon



*Gas Tank & Straps continued in next page*

# FALCON / FAIRLANE / RANCHERO

## Fuel Tank & Straps

**T09**  
1962-65 Fairlane, Fuel Tank

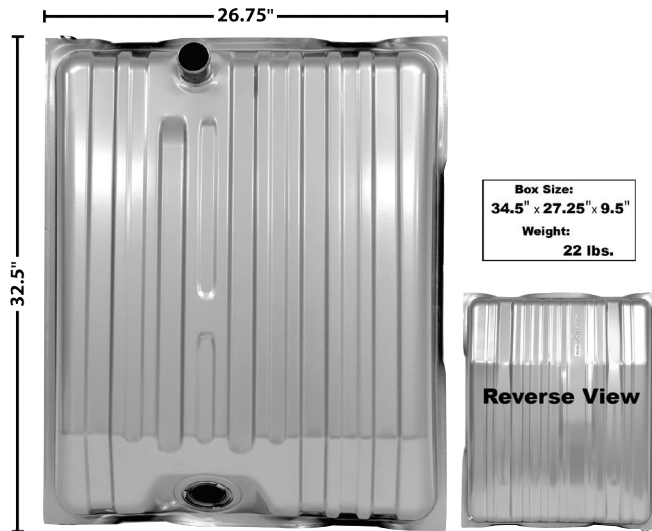

**T08**  
1964-65 Falcon / Ranchero / Wagon, Fuel Tank Straps, 2 Pcs.



**T3900**  
1966-67 Fairlane, Fuel Sending Unit, 3/8"

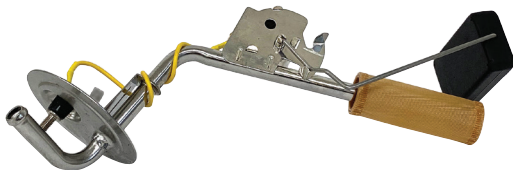

**T3901**  
1966-67 Fairlane, Fuel Sending Unit, 5/16"

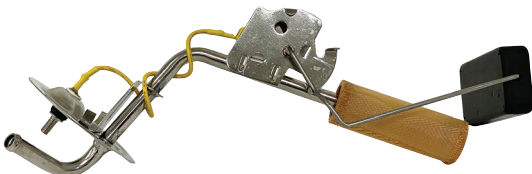

## Fuel Sending Unit

**T03B**  
1957-76 Fairlane, 64-67 Falcon, 66-79 Ranchero,  
Fuel Sending Unit Float

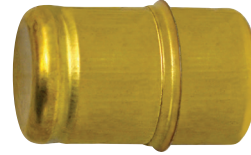

## Heating/Cooling Components

**M33882**  
1964-65 Falcon, Heater Blower Motor, 3-Speed, (After 4/1/65)



**M33883**  
1964-65 Falcon, Heater Blower Motor Assembly, 3-Speed  
(After 4/1/65)

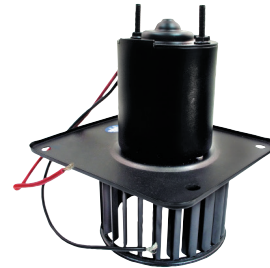

**3626D**  
1964-65 Falcon, Heater Control Assembly w/ Knobs,  
Switch & Hardware, 3-Speed.

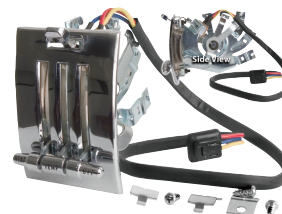

# FALCON / FAIRLANE / RANCHERO

## Heating/Cooling Components

**3626EA**

1964-65 **Falcon**, Heater Resistor, 3-Speed

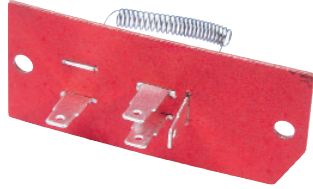

**M3515**

1964-Early 65 **Falcon**, Heater Box Assembly, No Hole for Resistor, 2-Speed

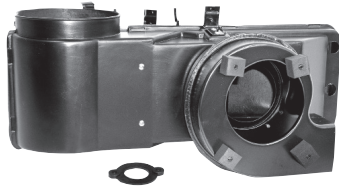

**M3516**

1964-65 **Falcon**, Heater Box w/ Gaskets & Clips, w/ Resistor Cut-Out, 3-Speed

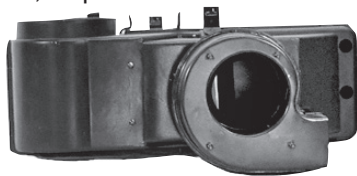

**M3518**

1964-65 **Falcon**, Heater Plenum

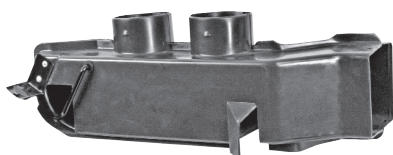

## Pedal Components

**3641SH**

1964-65 **Falcon**, Parking Brake Handle



**M3591 NEW**

1968-70 **Falcon**, 68-71 **Fairlane**, Disc Brake Pedal Pad, Standard

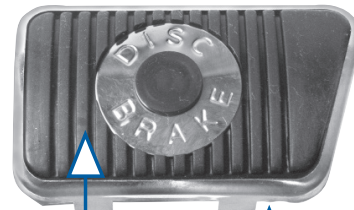

M3591 & M3599A

**M3593 NEW**

1966-70 **Falcon**, 66-71 **Fairlane**, Brake Pedal Pad, Standard

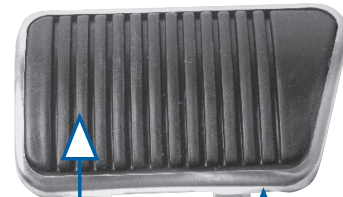

M3593 & M3599A

**M3594 NEW**

1966-70 **Falcon**, 70-71 **Fairlane**, Drum Brake Pedal Pad, Automatic Transmission



M3594 & M3599B

# FALCON / FAIRLANE / RANCHERO

## Pedal Components

### M3595 **NEW**

1967-71 Fairlane, 68-70 Falcon, Disc Brake Pedal Pad



M3595 & M3599B

### M3599A **NEW**

1968-71 Fairlane, 68-70 Falcon, Brake Pedal Trim, Standard

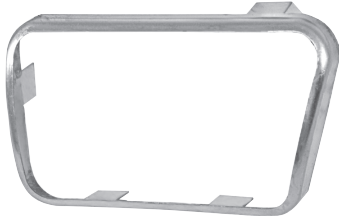

### M3599B **NEW**

1967-71 Fairlane, 68-70 Falcon, Brake Pedal Trim, Automatic Transmission

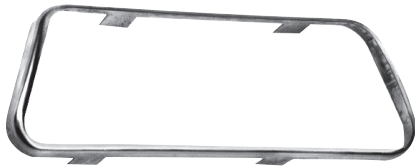

## Steering Wheels

### SW53

1961-63 Falcon, Steering Wheel, Black



## Bed Rail Molding

### M3351

1972-79 Ranchero, Bed Rail Molding, Pair  
**DYNACORN EXCLUSIVE!**

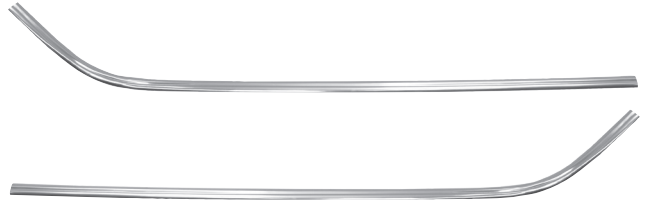

## Windshield Moldings

### M3471 **COMING SOON!**

1964-65 Falcon, Windshield Molding Set, Stainless Steel, 6 Pcs., Coupe

**DYNACORN EXCLUSIVE!**



## Drip Rail Moldings

### M3460 **NEW**

1964-65 Falcon, Drip Rail Molding, Pair  
**DYNACORN EXCLUSIVE!**

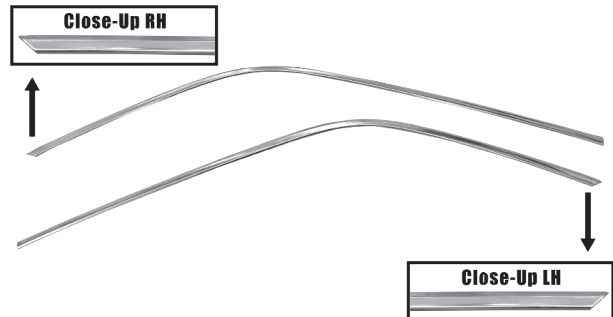

## Arm Rest

### 3115M

1968-69 Falcon / Ranchero, Arm Rest, Black, RH

### 3115N

1968-69 Falcon / Ranchero, Arm Rest, Black, LH



3115M



# FALCON / FAIRLANE / RANCHERO

## Decals

**ML01**

1960-66 **Falcon**, "Ford" Door Sill Decal, Black



## Interior Electrical

**M33900**

1960-70 **Falcon**, Horn Set w/ Brackets



**LH75 NEW**

1960-67 Fairlane/Falcon Ignition Switch w/ Small Ignition

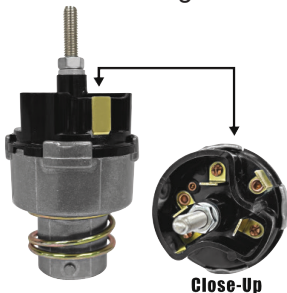

**LH71 NEW**

1962-70 Fairlane, Headlamp Switch



**LH75A NEW**

1966-67 Ignition Switch



**LH75B NEW**

1968-69 Ignition Switch w/ Large Ignition



## Ignition Locks

**CL-1400 NEW**

1952-59 Ignition Lock



**CL-364 NEW**

1960-63 Ignition Lock



**CL-1401**

1960-65 **Falcon**, Ignition Lock

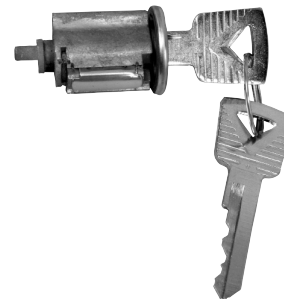

**CL-1402**

1966-69 **Falcon**, Ignition Lock



**CL-1404**

1970-73 **Falcon**, Ignition Lock, Before 5/13/73

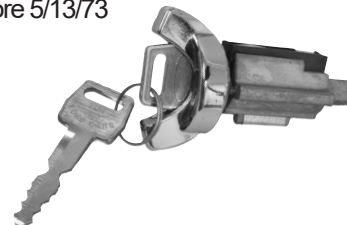

**CL-367**

1960-63 **Falcon**, Lock Kit Ignition and Door Ford Keys and Flip-cap Door Locks



# FALCON / FAIRLANE / RANCHERO

## Door Locks

### CL-300

1962-65 Fairlane, 64-65 Falcon,  
Door Locks



### CL-1550

1966-70 Fairlane, 66-73 Falcon,  
Door Locks



### CL-1555

1966-69 Falcon, Ignition & Door Locks



### CL-1556

1970-73 Falcon, Ignition & Door Locks,  
Before 5/13/73



## Ignition & Door Lock Kits

### CL-4877

1962-65 Fairlane, Lock Kit Ignition and  
Door, Standard Keys



### CL-363 *NEW*

1952-60 Fairlane, 52-58 Falcon, Lock  
Ignition & Door



### CL-1552 *NEW*

1966-70 Fairlane, 65-73 Falcon,  
Lock Ignition & Door

