

*Golden Leaf
Automotive*

BRONCO

2025



Ford Bronco Index

A

Accelerator Pedal Assembly: 32
Air Vent Assembly: 31
“A” Pillar: 19
Arm Rest: 35

B

Battery “J” Bolt Kit: 3
Battery Monitor: 37
Battery Trays & Hold Downs: 3
Bed Floor Molding: 28
Bedside Panels: 23
Bedside Upper Wheel Arch: 23
Bed Stake Corner: 24
Blower Motor/Fan Assembly: 3
Body Molding: 27, 28
“B” Pillar: 19
Braces: 5
Brake/Clutch Pedal Assembly: 32
Bumpers: 1, 2
Bumpers & Components: 1, 2

C

Cab Components: 11
Cowl Extension Plate: 9
Cowl Panels & Components: 9

D

Dash Pad: 9
Dash Panel: 9
Decals: 31
Door Accessories: 20, 21
Door Glass Run Channel: 22
Door Handle Relay: 21
Door Hinge: 17
Door Hinge Bushing: 18
Door Inner Panel: 17
Door Inside Handle: 21
Door Latch: 18
Door Molding with Clips: 27
Door Outer Handle: 20
Door Post ‘B’ Pillars: 19
Doors & Hardware: 16, 17, 18, 19, 20
Door Shell: 16, 17
Door Skin: 17
Door Striker: 18
Doors Window Frames: 22
Door Window Components: 22
Door Window Crank: 21
Door Window Frame: 22
Door Window Guide: 22

E

Engine Compartment: 3, 4
Exterior Door Handles: 20
Exterior Electrical & Components: 24, 25
Exterior & Interior Mirrors: 30, 31
Exterior Mirrors: 30, 31

F

Fender Flare Kit: 25
Fenders: 5

Fender Aprons: 4
Fender to Radiator Braces: 5
Firewall/ Cowl Assy: 6, 7
Floor Pan Brace: 10
Floor Pans & Components: 10, 11
Floor Pan Support Braces: 11
Fresh Air Vent Assembly: 31
Front Fender Flare: 25
Front Fender Molding: 27
Front Inner Fenders: 4, 5
Front Wheel Opening: 29
Fuel Tank Strap, & Senders: 26, 27

G

Gas Tank & Components: 32
Gas Tank Filler Neck: 32
Glove Box Door: 9
Grille: 27

H

Half-Cab Panels: 12
Head Lamp & Components: 2, 3
Heater Box: 31
Heater Intake Plenum: 31
Heating/ Cooling: 31
Hood Adjuster Bumpers: 8
Hood Hinge: 8
Hood Latch Support: 8
Hoods & Components: 7, 8
Horn Set: 36

I

Interior Electrical: 36
Interior Pieces: 28
Interior Trim: 28

L

License Plate Bracket: 2
Locks: 36

M

Molding Clips: 28

O

Oil Pan: 3, 4

P

Parking Brake Cable: 32
Park Lamp: 25
Park Lamp Lens & Housing: 25
Pedal Assemblies: 32

Q

Quarter Panels: 23
Quarter Window Molding: 30

R

Radiator Fan Shroud: 6
Radiator Support: 6
Radios: 37
Rear Floor Crossrail: 11

Rear Quarter Molding: 28
Rear Seat Arm Rest: 35
Rear Wheel Opening: 29
Rear Window Props: 15
Rocker Panel Moldings: 27
Rocker Panels: 12, 13
Roof Headliner Trim: 28
Roof Panel & Braces: 14, 15
Roof Support Bow: 14
Roof Surround Drip Molding: 30

S

Seat Back Spring: 36
Seat Belts: 33
Seat Bottom Spring: 36
Seat Components: 34, 35
Seat Frame Assembly: 36
Seat Frame Bottom: 35
Seat Side Molding: 35
Seat Track Assembly: 35
Sill Trim: 28

T

Tail Gate: 14
Tail Gate & Components: 13, 14
Tail Gate Handle: 13
Tail Gate Hinge: 13
Tail Gate Molding: 28
Tail Gate Seal Retainer: 28
Tail Gate Supports: 13
Tail Gate Trim: 28
Tail Lamp Bezel: 24
Tail Lamp Lens: 24
Tail Lamp Panel: 24
Tank Filler Guard: 23
Top Side Window Panel: 15

V

Vent Window Assemblies: 22
Vent Window Handles: 21

W

Wheelhouse: 26
Wheelhouse Fill Plate: 26
Wheel Opening Moldings: 29
Window Crank Knob Kit: 21
Window Frame Molding Kit: 30
Window Frames: 15
Window Molding: 29, 30
Window Panel: 15
Window Props: 15
Window Regulator: 20
Window Rollers & Clips: 19
Windshield Frame: 15
Windshield Frame Hinge: 15
Windshield Molding Kit: 30
Windshield Mount Cowl: 9
Windshield Wiper Motor: 4
Windshield Wiper Transmission Arm: 9
Wiper Arm: 9
Wiper Motor: 4

Ford Oval and Mustang are registered trademarks owned by Ford Motor Company.



Bumpers & Components

3700

1966-77 Front or Rear Bumper, Chrome



3701

1966-77 Front or Rear Bumper, Painted



3009 NEW

1980-86 Front Bumper, Chrome w/o Impact Strip Holes



3009C NEW

1987-91 Front Bumper, Chrome w/o Impact Strip Holes



3009D NEW

1987-91 Front Bumper, Chrome w/ Impact Strip Holes

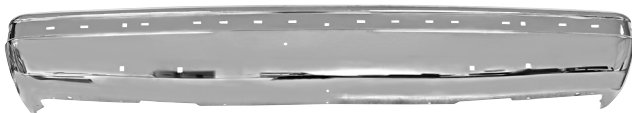

3009E NEW

1987-91 Front Bumper, Chrome w/o Impact Strip Holes



3009F NEW

1992-96 Front Bumper Chrome, w/o Impact Strip Hole Gas Engine



3009G NEW

1992-96 Front Bumper Chrome, w/ Impact Strip Hole Gas Engine



3009H NEW

1992-96 Front Bumper Painted, w/o Impact Strip Hole Gas Engine



3009EA NEW

1987-91 Front Bumper Pad

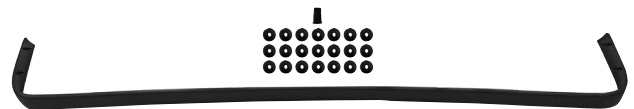

Bumpers & Components

3046C **NEW**

1987-91 Front Bumper Spoiler, Plastic

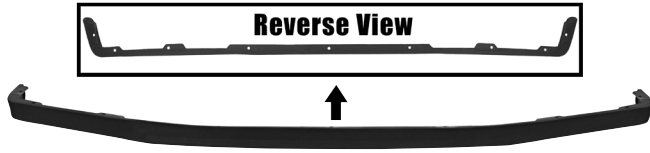

3009K **NEW**

1992-98 Front Bumper Center Pad, XLT/Eddie Bauer



3046A **NEW**

1980-86 Front Bumper Filler



3046D **NEW**

1992-96 Bumper Filler



3705 **COMING SOON!**

1966-77 License Plate Bracket, Stainless



3009N **NEW**

1992-96 Bumper License Bracket



3025E **NEW**

1992-96 Bumper Mounting Arm, RH

3025F **NEW**

1992-96 Bumper Mounting Arm, LH



3025E

3636B

1965-68 Bumper Bolt Kit



Head Lamp & Components

3038L **NEW**

1992-96 Headlamp Door, RH, Chrome / Gray

3038M **NEW**

1992-96 Headlamp Door, LH, Chrome / Gray

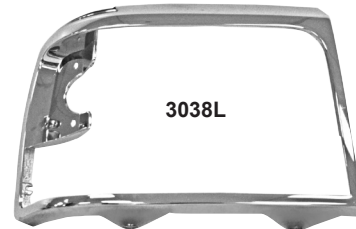

3038L

3038J **NEW**

1992-96 Head Lamp Door, RH, Argent

3038K **NEW**

1992-96 Head Lamp Door, LH, Argent



3038J

Head Lamp & Components

X3694
1966-77 Head Lamp Retaining Ring



L3700
1966-70 Headlamp Bezel, Chrome



L3702
1966-70 Headlamp Bezel, Black



L3701
1971-77 Head Lamp Bezel, Chrome



L3703
1971-77 Head Lamp Bezel, Black



Engine Compartment

M3537
1966-77 Battery Hold-Down



3095B NEW
1978-79 Battery Hold Down



M3537A
1966-89 Battery "J" Bolt Kit



3704
1966-77 Battery Tray Bottom



3094 NEW
1978-79 Battery Tray



3097 NEW
1987-96 Battery Tray, RH,
Gas Engine

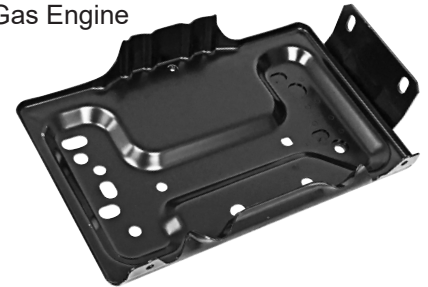

M33884
1966-77 Blower Motor /
Fan Assembly

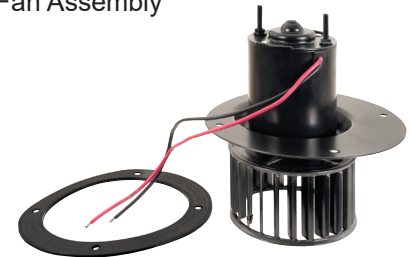

3059G NEW
1983-96 Oil Pan, I6, 4.9L



3059F NEW
1980-82 Oil Pan, V6, 4.9L



Engine Compartment

3059E *NEW*

1988-96 Oil Pan, V8, 5.8L



3059D *NEW*

1981-87 Oil Pan, V8, 5.8L



3733A

1966-77 Wiper Motor, Plastic Cover, White
DYNACORN EXCLUSIVE!



3733B

1966-77 Wiper Motor, Plastic Cover, Black
DYNACORN EXCLUSIVE!



M33889

1969-77 Windshield Wiper Motor

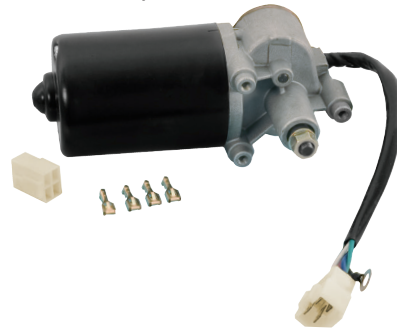

Fender Aprons

3699S

1966-77 Fender Apron, RH

3699T

1966-77 Fender Apron, LH

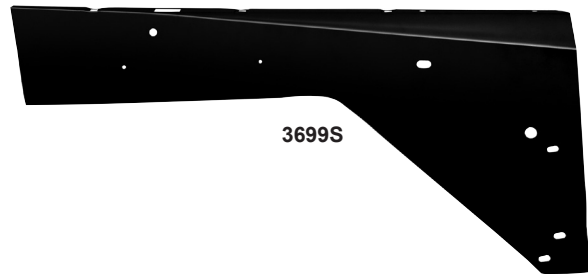

3699S

Front Inner Fenders

3699Q

1966-77 Front Inner Fender, RH

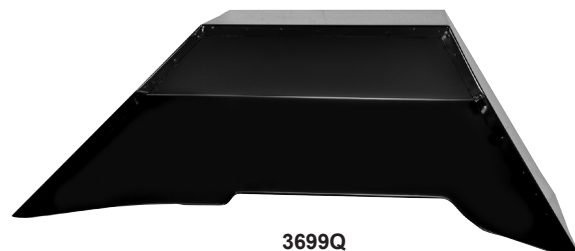

3699Q

Front Inner Fenders

3699R
1966-77 Front Inner Fender, EDP, LH



3071C NEW
1987-91 Fender, RH

3071D NEW
1987-91 Fender, LH



Fenders

3699N
1966-77 Front Fender, RH
New Tooling

3699P
1966-77 Front Fender, LH
New Tooling



3071E NEW
1992-96 Fender, RH

3071F NEW
1992-96 Fender, LH



3071A NEW
1980-86 Fender, RH

3071B NEW
1980-86 Fender, LH



Braces

3709AWT
1966-77 Fender-to-Radiator Braces,
Weld Through Primer, 3 Pcs.



Radiator Fan Shroud

3139 NEW
1980-91 Radiator Fan Shroud, 8 Cyl., Gas Engine



3139C NEW
1992-96 Radiator Fan Shroud, V6 A/T

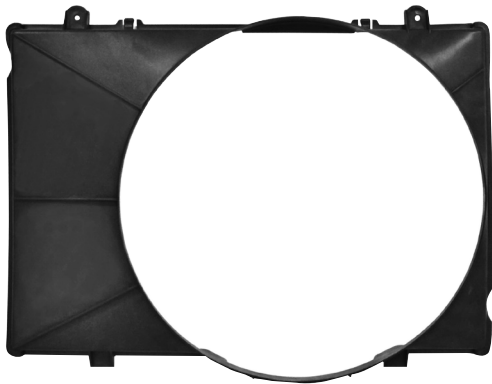

3139D NEW
1992-96 Radiator Fan Shroud, V6, M/T

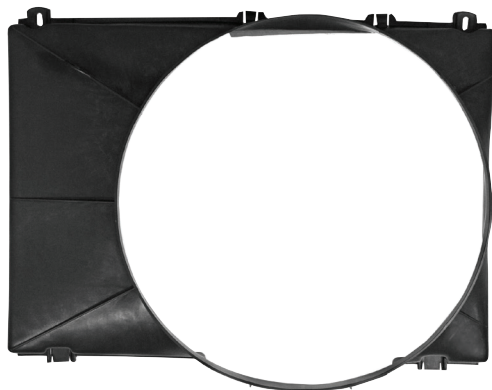

Radiator Support

3709WT
1966-77 Radiator Support, Weld Through Primer

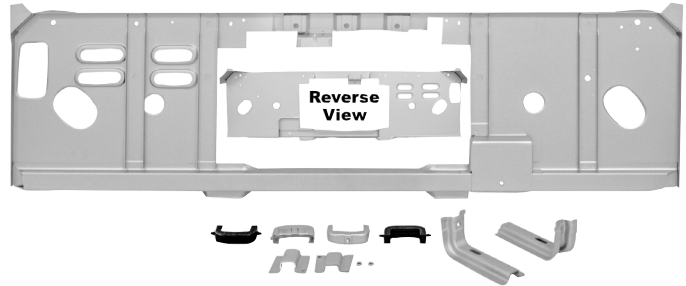

3136 NEW
1978-79 Radiator Support, 2 Mount Support



3135 NEW
1978-79 Radiator Support, 4 Mount Support



Firewall / Cowl Assy

SW49 COMING SOON!
1966-77 Steering Column to Firewall Bracket



Firewall / Cowl Assy

3744WT

1966-77 Firewall/Cowl Assembly, Weld Through Primer, Not Welded Together

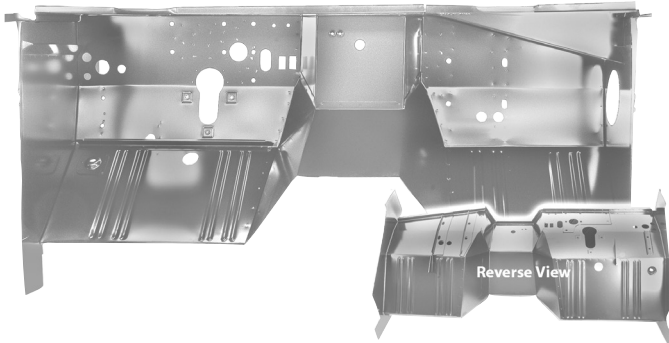

3750A NEW

1966-77 Hood w/ 2" Cowl w/ Vents

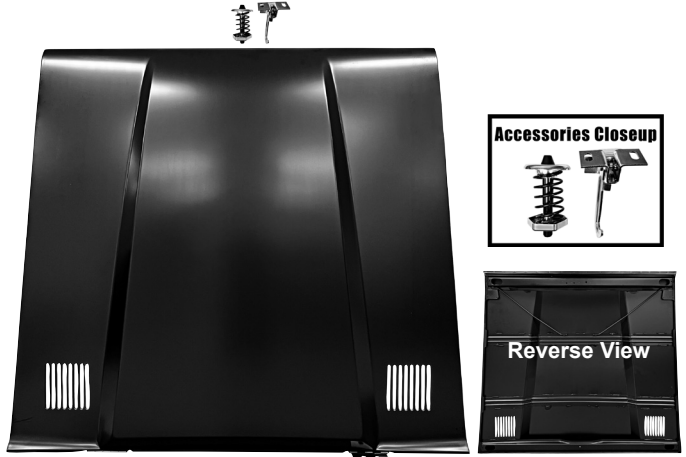

Hoods & Components

3750

1966-77 Hood w/o Windshield Hook Hole



3750B NEW

1966-77 Hood w/ 2" Cowl w/o Vents

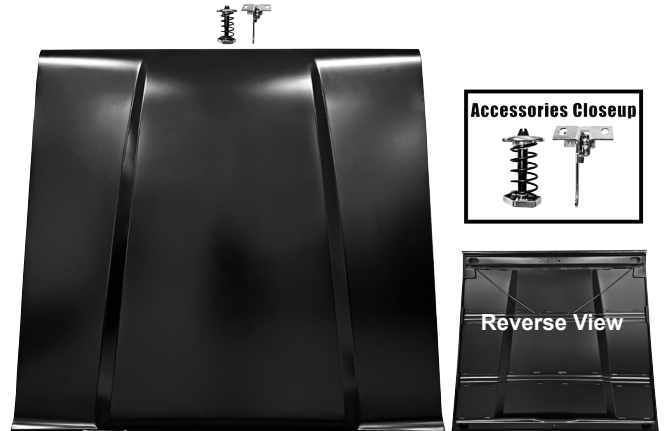

3750NV

1966-77 Custom Hood w/o Vent Holes or Window Hook Holes



3751

1966-69 Hood w/ Windshield Hook Holes



Hoods & Components

3050A NEW
1980-86 Hood

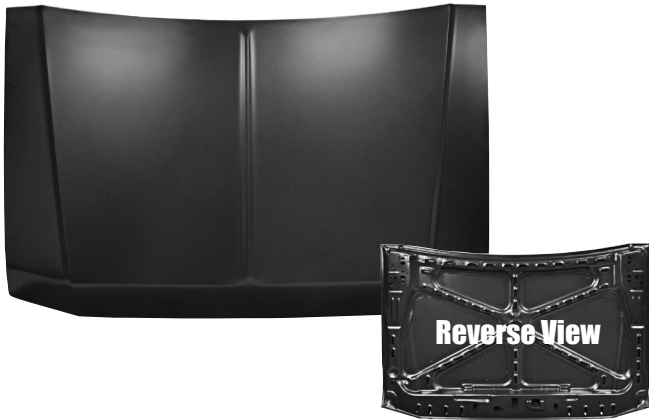

3050B NEW
1987-91 Hood



3050C NEW
1992-96 Hood



3708
1966-77 Hood Latch Support

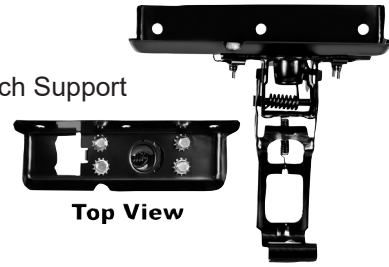

3055A NEW
1992-96 Hood Hinge, RH
3055B NEW
1992-96 Hood Hinge, LH



3050D NEW
1987-96 Hood Latch

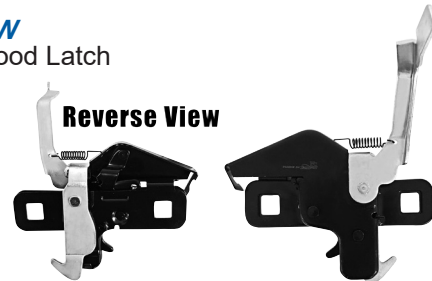

3751A COMING SOON!
1966-77 Hood Prop Rod



M3510
1968-77 Hood Adjuster Bumpers
(On Radiator)



Cowl Panels & Components

3734WT
1966-67 Lower Cowl Panel, Weld Through Primer



3735WT
1968-77 Lower Cowl Panel, Weld Through Primer



3732WT
1966-67 Windshield Cowl Mount, Weld Through Primer

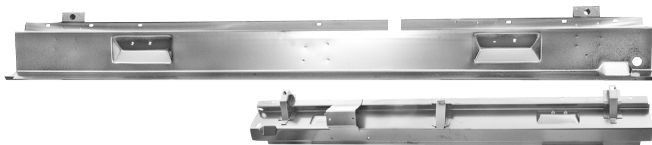

3732AWT
1968-77 Windshield Cowl Mount, Weld Through Primer

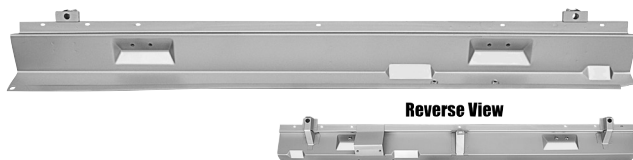

3738
1966-77 Cowl Side Panel, RH

3739
1966-77 Cowl Side Panel, LH



3730A
1966-77 Cowl Extension Plate Set, 4 Pcs.

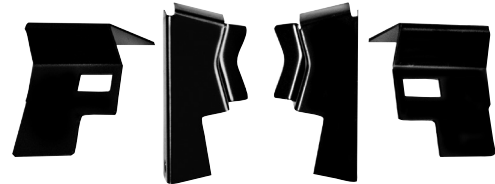

Wiper Arm

3733
1969-77 Windshield Wiper Transmission Arm



3117Q NEW
1978-79 Wiper Arm, RH=LH

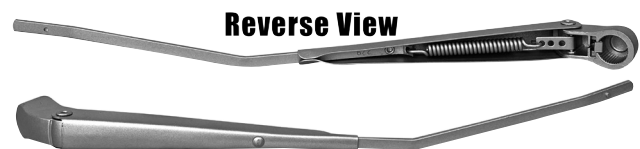

Dash Panel

3724
1968-77 Dash Panel Assembly, Weld Through Primer



3724A
1968-77 Dash Pad



3724E NEW
1966-77 Glove Box Door w/ Hinge



Floor Pans & Components

3741WT

1966-67 Front Floor Pan, Weld Through Primer

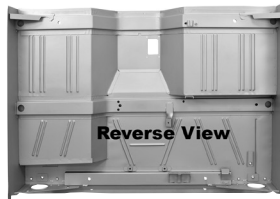
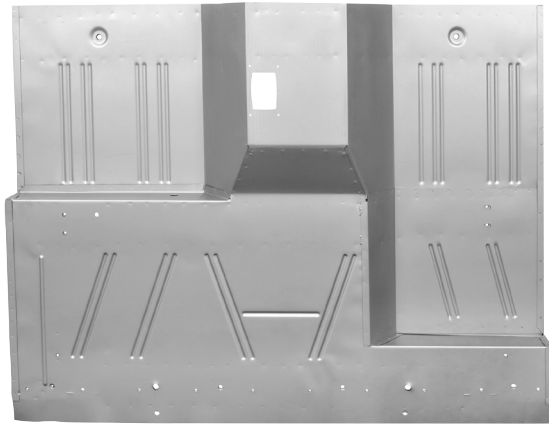

3743WT

1968-77 Front Floor Pan, Weld Through Primer

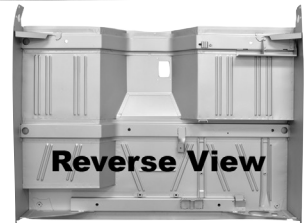
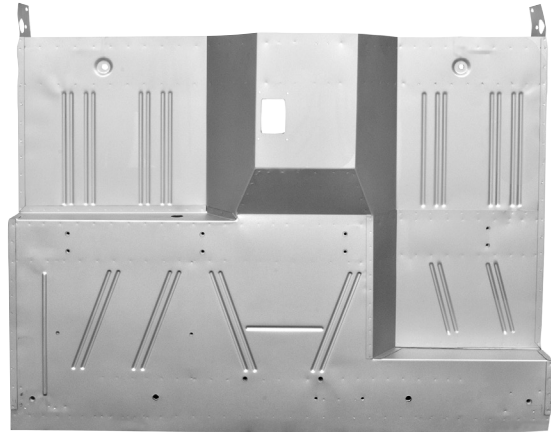

3740

1966-77 Rear Floor Pan



3745A

1966-67 Floor Pan Brace, Front



3745B

1966-67 Floor Pan Brace, Center



3746A

1968-77 Floor Pan Brace, Front



3746B

1968-77 Floor Pan Brace, Center



Floor Pans & Components

3745CWT

1966-67 Floor Pan Brace, Rear, Weld Through Primer



3746CWT

1968-77 Floor Pan Brace, Rear, Weld Through Primer



3742

1966-77 Rear Floor Crossrail



3746E

1966-67 Floor Pan Support Braces, Rear, Pair

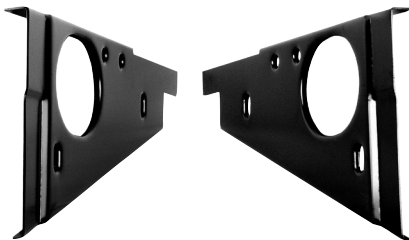

3746F

1968-77 Floor Pan Support Braces, Rear, Pair



3746D

1966-77 Floor Pan Support Braces, Front, Pair



Cab Components

3155J *NEW*

1980-96 Cab Floor Footwell Section



3155L *NEW*

1980-96 Cab Floor Front Section, LH



3155M *NEW*

1980-96 Cab Mount Panel, RH

3155N *NEW*

1980-96 Cab Mount Panel, LH



Reverse View



3155M

Half-Cab Panels

3756WT

1966-77 Half-Cab Panel Set, 5 Pcs.,
Weld Through Primer
DYNACORN EXCLUSIVE!



3752BWT

1966-77 Half-Cab Roof Drip Rail
Set, 7 Pcs., Weld Through Primer
DYNACORN EXCLUSIVE!



Rocker Panels

3760WT

1966-77 Outer Rocker Panel, RH=LH,
Weld Through Primer

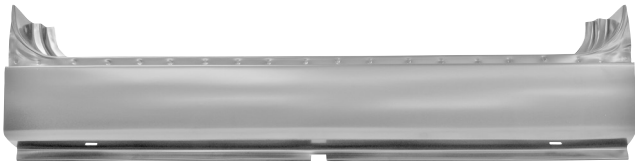

3760AWT

1966-67 Inner Rocker Panel, RH, Weld Through Primer

3760BWT

1966-67 Inner Rocker Panel, LH, Weld Through Primer



3760CWT

1968-77 Inner Rocker Panel, RH, Weld Through Primer

3760DWT

1968-77 Inner Rocker Panel, LH, Weld Through Primer



3114AC **NEW**

1980-96 Rocker Panel, RH, OE Type

3114AD **NEW**

1980-96 Rocker Panel, LH, OE Type

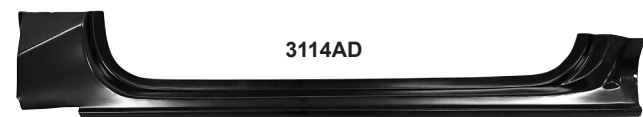

Rocker Panels

3114AE NEW
1980-86 Rocker Panel, RH

3114AF NEW
1980-86 Rocker Panel, LH



3114AG NEW
1987-96 Rocker Panel, RH

3114AH NEW
1987-96 Rocker Panel, LH



3791AS
1966-77 Tail Gate, Supports, Stainless, Pair

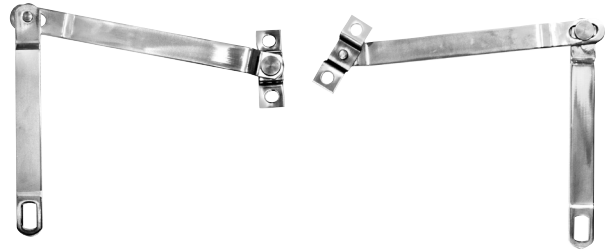

3790A COMING SOON!
1966-77 Tail Gate Handle



Tail Gate & Components

3791S
1966-77 Tail Gate Hinge, Pair, Stainless



3791
1966-77 Tail Gate Hinge, Pair, Black

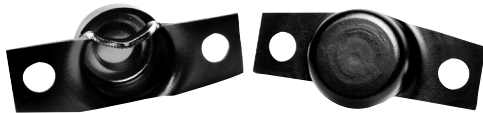

3791A
1966-77 Tail Gate, Hinge Trunnions, Pair, Black



3790B COMING SOON!
1966-77 Tail Gate Handle Mount



3304R NEW
1980-96 Tailgate Release Handle

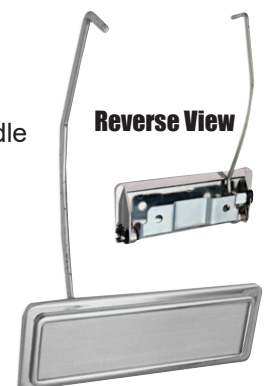

Tail Gate & Components

3790
1966-77 Tail Gate, w/o Logo



3304P NEW
1978-82 Tail Gate



3304Q NEW
1983-96 Tail Gate



Roof Panel & Braces

3752C
1966-77 Roof Support Bow, Full Top



3752WT
1966-77 Roof Panel,
Weld Through Primer



3753WT
1966-77 Roof Panel Assembly w/ Braces,
Weld Through Primer



Roof Panel & Braces

3752AWT

1966-77 Roof Inner Braces, 7 Pcs., Weld Through Primer



Window Frames

3736

1966-77 Rear Window Props, Pair



3731

1966-77 Windshield Frame Hinge

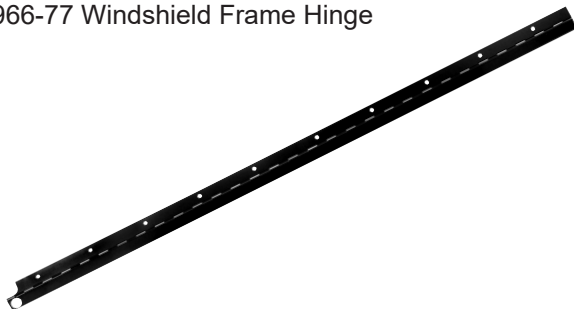

3730

1966-77 Windshield Frame



3737

1966-77 Rear Window Frame

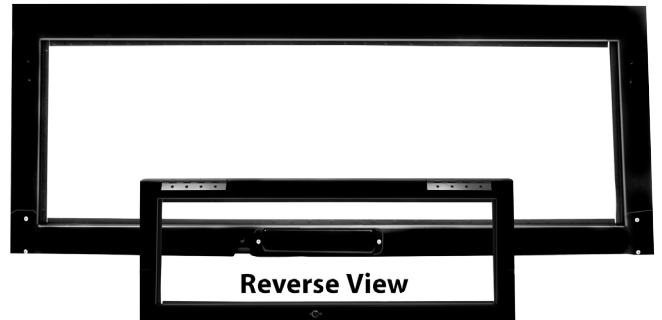

3754

1966-77 Top Side Window Panel, RH
(Includes Mounting Bracket & Gusset)

3755

1966-77 Top Side Window Panel, LH
(Includes Mounting Bracket & Gusset)

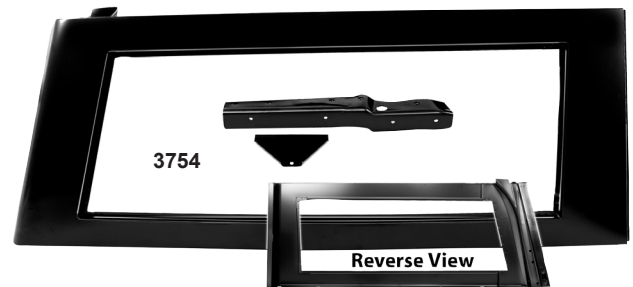

Doors & Hardware

3710
1966-67 Door Shell, RH
3711
1966-67 Door Shell, LH



3113A NEW
1980-86 Door Shell, RH
3113B NEW
1980-86 Door Shell, LH



3718
1968-77 Door Shell, RH
3719
1968-77 Door Shell, LH



3113C NEW
1987-91 Door Shell, RH w/ Paddle
Design Mirror
3113D NEW
1987-91 Door Shell, LH w/ Paddle
Design Mirror



Doors & Hardware

3711A
1966 Door Skin, RH

3711B
1966 Door Skin, LH, No Key Hole



3719A
1968-77 Door Skin, RH

3719B
1968-77 Door Skin, LH



3719D
1966-77 Door Inner Panel, RH

3719E
1966-77 Door Inner Panel, LH

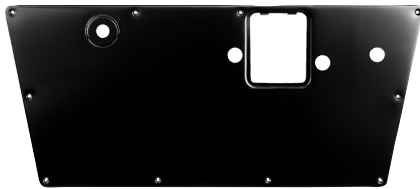

3716A
1968-77 Door Latch Rod Kit, RH

3716B
1968-77 Door Latch Rod Kit, LH

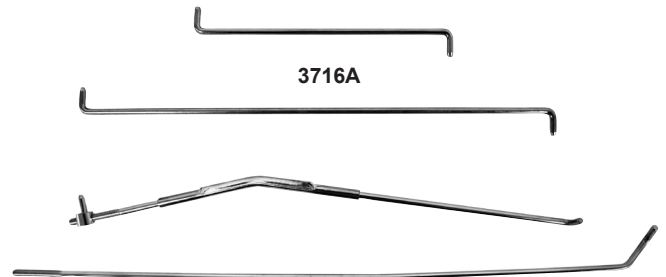

3715A
1966-77 Door Hinge, RH

3715B
1966-77 Door Hinge, LH



3116G NEW
1980-96 Door Lower Hinge, RH=LH



3116J
1980-96 Door Upper Hinge, RH

3116K
1980-96 Door Upper Hinge, LH

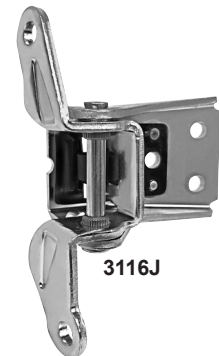

Doors & Hardware

3640QB NEW
1978-79 Door Hinge Bushing,
2 Needed Per Hinge



3641NA
1966-67 Door Striker

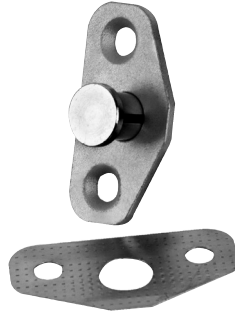

3113F COMING SOON!
1973-80 Door Striker Kit



3714
1968-77 Door Latch, RH

3715
1968-77 Door Latch, LH



3714

M3546A
1968-77 Door Striker Set, Stainless

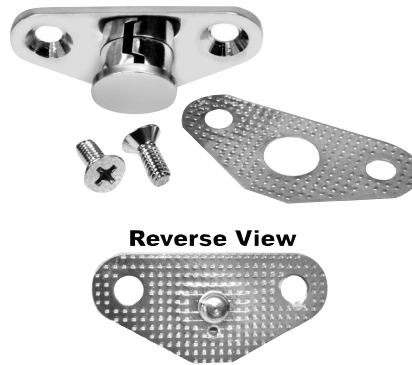

3113E NEW
1980-96 Door Striker Kit



M3616G
1966-67 Door Latch, RH

M3616H
1966-67 Door Latch, LH



M3616G

M3546
1968-77 Door Striker Set, Zinc Plated



3113G NEW
1984-90 Door Striker Kit, Bronco II



Doors & Hardware

3719FWT

1966-67, "A" Pillar, RH,
Weld Through Primer

3719GWT

1966-67, "A" Pillar, LH,
Weld Through Primer



3719CWT

1968-77 "B" Pillars (4 Pcs.),
Weld Through Primer



3719LWT

1966-77 "B" Pillar Reinforcement, RH,
Weld Through Primer

3719MWT

1966-77 "B" Pillar Reinforcement, LH,
Weld Through Primer



3719JWT

1968-77 "A" Pillar, 2 Pcs., RH,
Weld Through Primer

3719KWT

1968-77 "A" Pillar, 2 Pcs., LH,
Weld Through Primer



3716WT

1966-67 "B" Pillar, RH
(Includes Latch Striker),
Weld Through Primer

3717WT

1966-67 "B" Pillar, LH
(Includes Latch Striker),
Weld Through Primer



M3692B

1966-77 Window Rollers & Clips,
50 Ct. bag

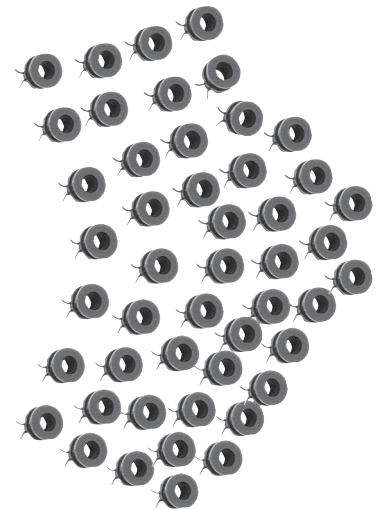

Doors & Hardware

3124A **NEW**

1973-79 Window Regulator, 1/4" Screw Hole, RH

3124B **NEW**

1973-79 Window Regulator, 1/4" Screw Hole, LH

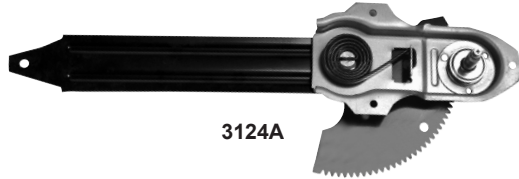

3124A

3124E **NEW**

1980-96 Window Power Regulator, RH w/ Motor

3124F **NEW**

1980-96 Window Power Regulator, LH w/ Motor

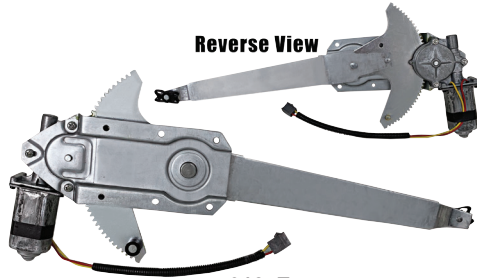

Reverse View

3124E

3124C **NEW**

1980-86 Window Regulator, RH, Manual

3124D **NEW**

1980-86 Window Regulator, LH, Manual

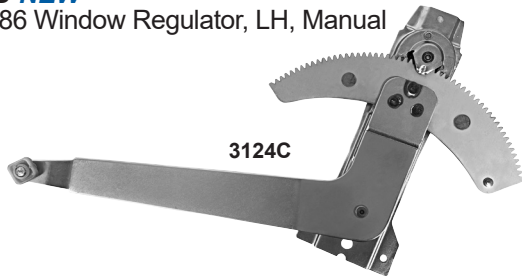

3124C

3124G **NEW**

1992-96 Window Regulator, RH, Manual

3124H **NEW**

1992-96 Window Regulator, LH, Manual



3124G

Door Accessories

M3616

1966-67 Exterior Door Handles



(Reuse internal mechanism)

3719P

1968-77 Door Outer Handle, RH

3719Q

1968-77 Door Outer Handle, LH

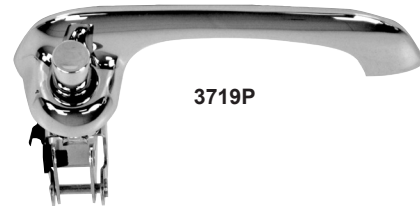

3719P

3115P **NEW**

1980-96 Door Outside Handle, RH, Chrome

3115Q **NEW**

1980-96 Door Outside Handle, LH, Chrome



Reverse View

3115P

3115PA **NEW**

1980-96 Door Outside Handle, RH, Black

3115QA **NEW**

1980-96 Door Outside Handle, LH, Black



Reverse View

3115PA

Door Accessories

3115RA **NEW**

1980-96 Door Inside Handle, RH, Chrome

3115SA **NEW**

1980-96 Door Inside Handle, LH, Chrome



3115SA

3115R **NEW**

1980-96 Door Inside Handle, RH, Black

3115S **NEW**

1980-96 Door Inside Handle, LH, Black



Reverse View



3115R

M3529C

1966-67 Vent Window Handles



M3529D

1968 Vent Window Handles, w/o Nylon Wear Tab



M3529E

1968-77 Vent Window Handles, w/ Nylon Wear Tab



D3616

1966-67 Door Handle Relay, RH

D3617

1966-67 Door Handle Relay, LH

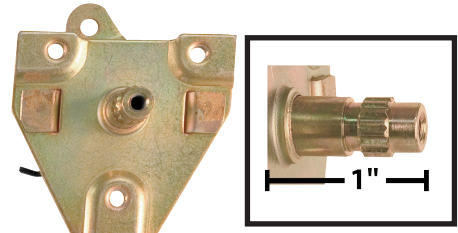

D3616

M3528

1968-77 Door Window Crank (No Knob)



M3525A

1968-77 Window Crank Knob Kit, Black, 3 Pcs.



M3525B

1968-77 Window Crank Knob Kit, Clear, 3 Pcs.



Door Window Components

3719X
1966-77 Door Glass Run Channel, Pair

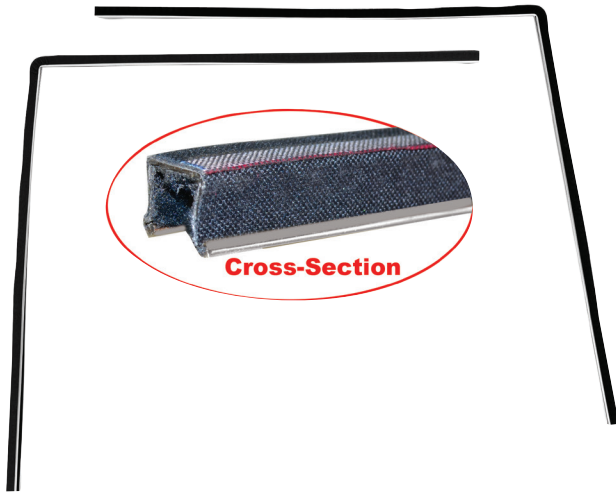

3712
1966-77 Door Window Frame,
Bolt In Frames, RH

3713
1966-77 Door Window Frame,
Bolt In Frames, LH

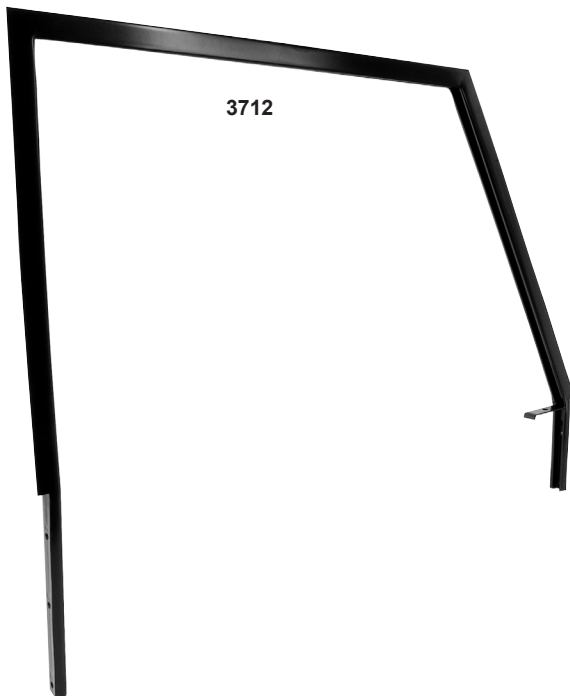

3713D
1966-77 Door Window Guide, 4 Pcs.

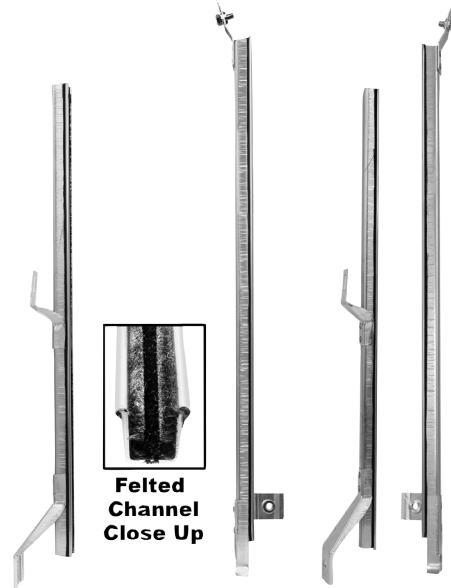

Vent Window Assemblies

3722
1966-77 Vent Window Assembly, RH

3723
1966-77 Vent Window Assembly, LH



Clear Glass

Tank Filler Guard

3782WT
1968-77 Tank Filler Guard

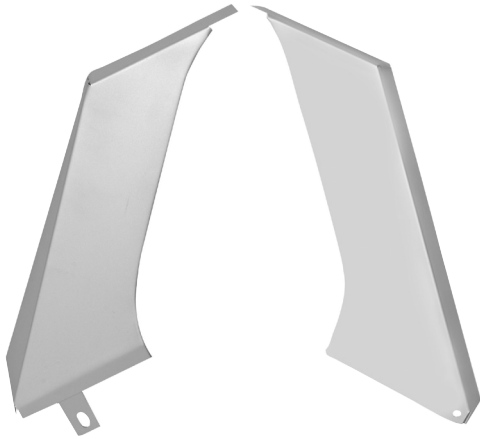

Quarter Panels

3792
1966-77 Quarter / Bed Panel, RH

3793
1966-76 Quarter / Bed Panel, LH



3791AWT
1966-77 Lower Quarter Panel Skin, RH,
Weld Through Primer

3791BWT
1966-76 Lower Quarter Panel Skin, LH,
Weld Through Primer



Bedside Panels

3267L NEW
1978-79 Bedside Panel, RH

3267M NEW
1978-79 Bedside Panel, LH



3269G NEW
1980-86 Bedside Upper Wheel Arch, RH

3269H NEW
1980-86 Bedside Upper Wheel Arch, LH



3269M NEW
1987-96 Bedside Upper Wheel Arch, RH

3269N NEW
1987-96 Bedside Upper Wheel Arch, LH

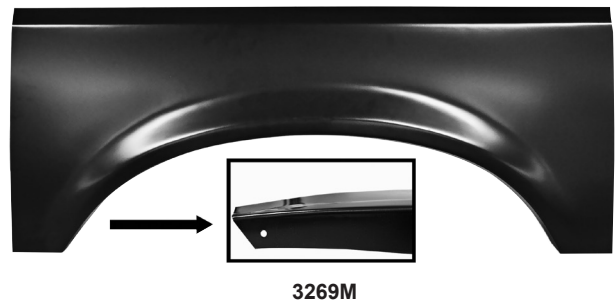

Bed Stake Corner

3797WT

1966-77 Bed Stake Corner, RH,
Weld Through Primer

3798WT

1966-77 Bed Stake Corner, LH,
Weld Through Primer



**Shown behind
Part # 3794
Right Hand Tailgate
Corner Panel**

3794

1966-77 Tail Lamp Panel, RH

3795

1966-77 Tail Lamp Panel, LH



L3710

1966-77 Tail Lamp Lens, RH

L3710A

1966-77 Tail Lamp Lens, LH



L3220 *NEW*

1987-91 Tail Lamp Lens & Housing,
RH

L3221 *NEW*

1987-91 Tail Lamp Lens & Housing,
LH



Exterior Electrical & Components

L3711

1966-77 Tail Lamp Bezel, Pair



L3222 *NEW*

1992-96 Tail Lamp Assembly, RH

L3223 *NEW*

1992-96 Tail Lamp Assembly, LH



Exterior Electrical & Components

L3200 **NEW**

1987-91 Head Lamp Assembly, RH

L3201 **NEW**

1987-91 Head Lamp Assembly, LH



L3200

L3202 **NEW**

1992-96 Head Lamp Assembly, RH

L3203 **NEW**

1992-96 Head Lamp Assembly, LH



L3202

L3210 **NEW**

1987-91 Park Lamp Lens & Housing, RH

L3211 **NEW**

1987-91 Park Lamp Lens & Housing, LH



L3210

L3212 **NEW**

1992-96 Park Lamp, RH, Amber

L3213 **NEW**

1992-96 Park Lamp, LH, Amber



L3212

Fender Flare Kits

3699W

1966-77 Fender Flare Kit, Front, Pair



3699WA

1966-77 Front Fender Flare Welting Kit, Does 2 Flares



Wheelhouse

3780AWT

1966-77 Wheelhouse Fill Plate, Weld Through Primer, RH

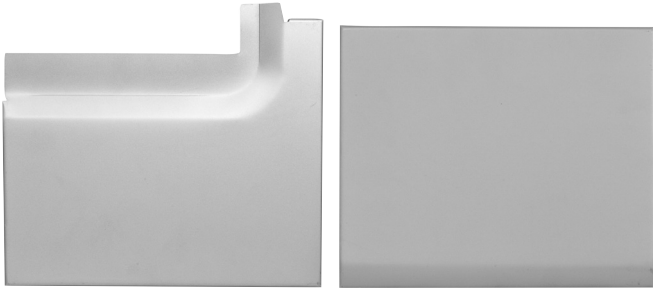

3781AWT

1966-77 Wheelhouse Fill Plate, Weld Through Primer, LH

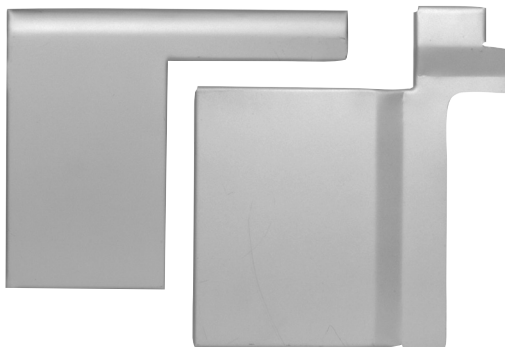

3780

1966-77 Rear Wheelhouse, RH

3781

1966-77 Rear Wheelhouse, LH



3780

3172 NEW

1980-86 Wheelhouse Inner, RH, Box Side

3172A NEW

1980-86 Wheelhouse Inner, LH, Box Side



3172

Fuel Tank, Straps, & Senders

T91

1970-72 Fuel Sending Unit, w/ Evap System



T90

1966-69 Fuel Sending Unit, w/o Evap System

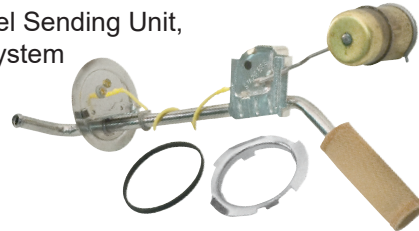

T3241 NEW

1985-86 Fuel Sending Unit

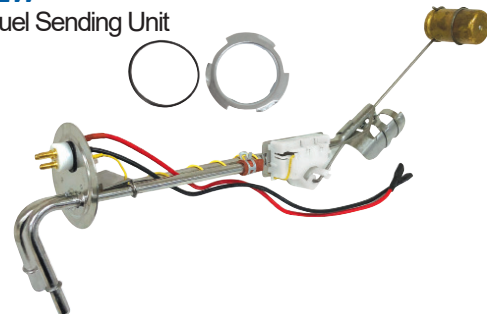

T3240 NEW

1978-79 Fuel Sending Unit, 3/8"

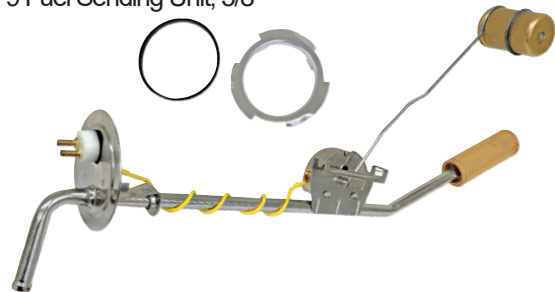

T03B

1966-77 Fuel Sending Unit Float



Fuel Tank, Straps, & Senders

T100A

1966-76 Gas Tank Strap for Rear Fuel Tank



T3011 *NEW*

1973-79 Gas Tank Strap, Rear Mount, Lower, 2 Pcs.



T3011A *NEW*

1973-79 Gas Tank Strap, Upper, 2 Pcs.



Grilles

3725

1966-68 Grille, w/o Logo, Painted

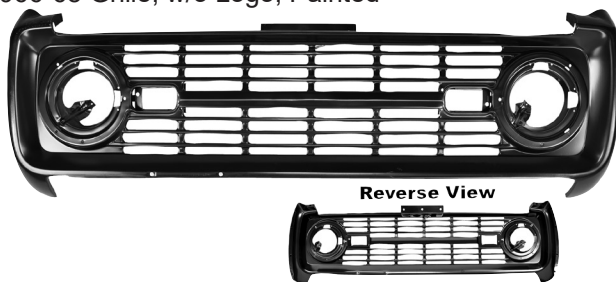

3725B

1969-77 Grille, w/o Logo, Painted

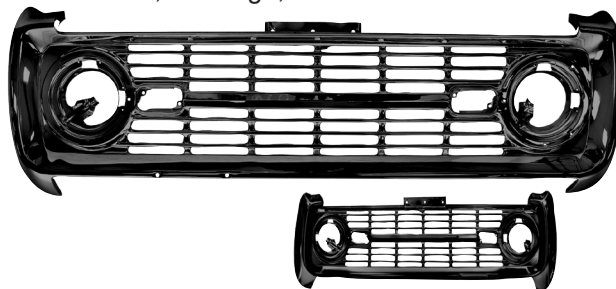

3725C

1966-68 Grille, w/o Logo, Chrome

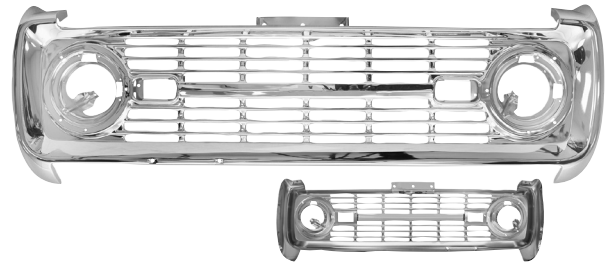

3725D

1969-77 Grille, w/o Logo, Chrome



3050E *NEW*

1992-96 Grille Opening Header Panel, Plastic



Body Molding

M3730

1966-77 Front Fender Molding w/ Clips, RH=LH



M3735

1966-77 Door Molding w/ Clips, RH=LH



M3766

1969-77 Rocker Panel Moldings w/ Clips, Stainless

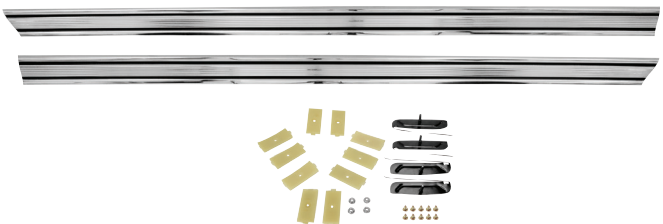

Body Molding

M3740
1966-77 Rear Quarter Molding w/ Clips
(w/Spare Tire Rack), RH



M3741
1966-77 Rear Quarter Molding w/ Clips
(No Spare Tire Rack), RH

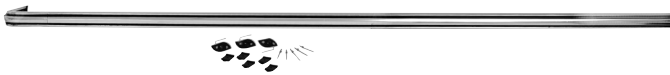

M3742
1966-77 Rear Quarter Molding w/ Clips, LH



M3750
1966-77 Tailgate Molding w/ Clips



M3200 *COMING SOON!*
1978-79 Tailgate Upper Molding w/ Clips



M3201 *NEW*
1978-79 Tailgate Lower Molding w/ Clips



M3760
1966-77 Molding Clips,
48 Pc. Set

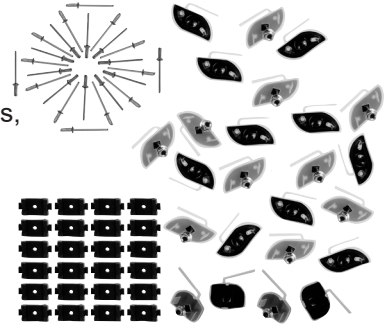

Interior Trim

M3765
1966-77 Bed Floor Trim, 2 Pcs., Stainless



M3751
1966-77 Tailgate Trim, 3 Pcs., Stainless



M3752
1966-77 Tailgate Seal Retainer, Stainless



M3767
1966-77 Sill Trim Set, 2 Pcs., w/ Screws, Stainless

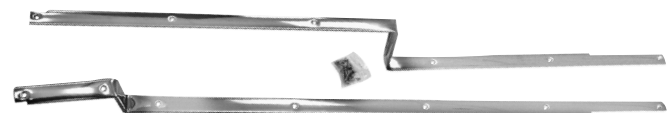

M3771
1966-77 Roof Headliner Trim, Stainless



Wheel Opening Moldings

M3700

1973-79 Front Wheel Opening Molding, RH

M3701

1973-79 Front Wheel Opening Molding, LH



M3700

M3702

1973-79 Rear Wheel Opening Molding, RH

M3703

1973-79 Rear Wheel Opening Molding, LH



M3702

M3704

1980-86 Front Wheel Opening Molding, RH

M3705

1980-86 Front Wheel Opening Molding, LH



M3704

M3706

1980-86 Rear Wheel Opening Molding, RH

M3707

1980-86 Rear Wheel Opening Molding, LH

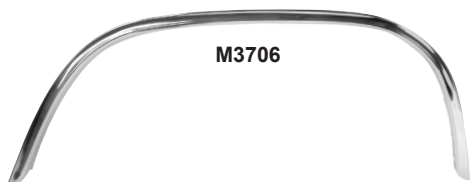

M3706

M3708

1987-96 Front Wheel Opening Molding, RH

M3709

1987-96 Front Wheel Opening Molding, LH



M3708

M3710

1987-96 Rear Wheel Opening Molding, RH

M3711

1987-96 Rear Wheel Opening Molding, LH



M3710

Window Molding

M3720

1980-86 Upper Molding Grille



M3721

1980-86 Lower Molding Grille



Window Molding

M3770

1966-77 Windshield Molding Kit, 5 Pcs.

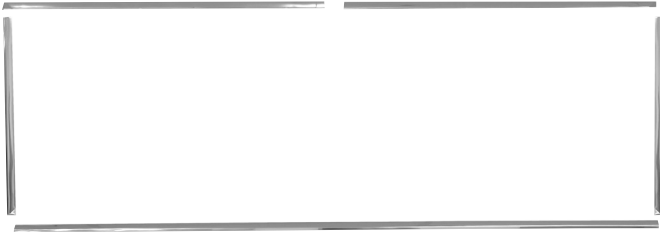

M3778

1966-77 Rear Window Molding Kit, 5 Pcs.



M3772

1966-77 Roof Surround Drip Molding, 4 Pcs., Set



M3774

1966-77 Window Frame Molding Kit, 6 Pcs.

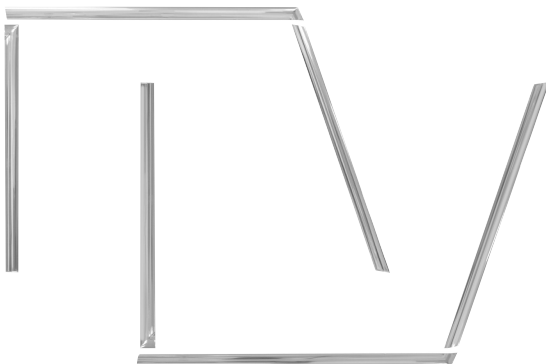

M3776

1966-77 Quarter Window Molding RH, 4 Pcs.

M3777

1966-77 Quarter Window Molding LH, 4 Pcs.



Exterior & Interior Mirrors

M3524B

1966 Exterior Mirror



M3524EC

1967 Exterior Mirror w/ Convex Glass & Gaskets



M3524E

1967 Exterior Mirror w/ Gaskets



Exterior & Interior Mirrors

3117A
1968-77 Exterior Mirror, Chrome



M3524F
1967 Mirror Gasket Kit Outside



M3522B
1966-77 Rear View Mirror



M3524A
1968-69 Rear View Mirror Mounting Bracket



Heating/Cooling

3720
1966-77 Heater Box

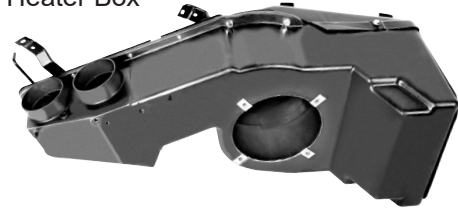

3726
1966-77 Heater Intake Plenum



3727
1966-77 Fresh Air Vent Assembly



Decals

ML01
1966-67 Black Door Sill Scuff Plate Decal



ML02
1967-77 Blue Door Sill Scuff Plate Decal



Pedal Assemblies

3771
1966-77 Manual Brake Pedal Assembly

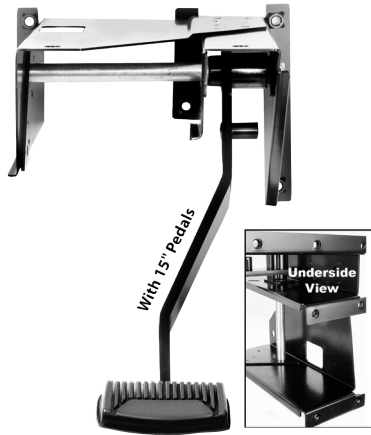

3789
1966-77 Brake/Clutch Pedal Assembly



3770 COMING SOON!
1966-77 Parking Brake Assembly



3721
1966-77 Parking Brake Cable/Floor Mount



3788 COMING SOON!
1966-77 Accelerator Pedal Assembly



Gas Tank & Components

T100
1966-76 Gas Tank



T102
1966-76 Gas Tank Filler Neck



Seat Belts



Seat Belts with Push Button:
6 colors to choose from



60 Inch Belts

SB-N2PB	Seat Belt with Push Button	Black
SB-N2PG	Seat Belt with Push Button	Grey
SB-N2PT	Seat Belt with Push Button	Tan
SB-N2PN	Seat Belt with Push Button	Navy Blue
SB-N2PR	Seat Belt with Push Button	Red
SB-N2PM	Seat Belt with Push Button	Maroon



Retractable with 12 " Sleeve & 7" Boot

SB-R2PB	Seat Belt with Push Button	Black
SB-R2PG	Seat Belt with Push Button	Grey
SB-R2PT	Seat Belt with Push Button	Tan
SB-R2PN	Seat Belt with Push Button	Navy Blue
SB-R2PR	Seat Belt with Push Button	Red
SB-R2PM	Seat Belt with Push Button	Maroon



SB-90BR

SB-90BR	90 Degree End Bracket
---------	-----------------------



Seat Belts with Lift Latch:
10 colors to choose from

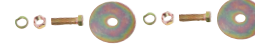

60 Inch Belts

SB-N2LB	Seat Belt with Lift Latch	Black
SB-N2LG	Seat Belt with Lift Latch	Grey
SB-N2LM	Seat Belt with Lift Latch	Maroon
SB-N2LN	Seat Belt with Lift Latch	Navy Blue
SB-N2LR	Seat Belt with Lift Latch	Red
SB-N2LT	Seat Belt with Lift Latch	Tan

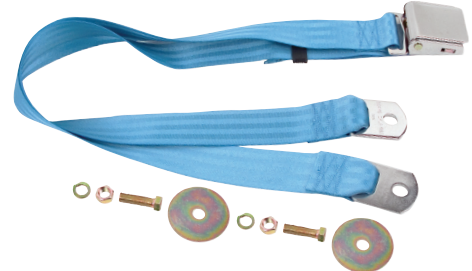

Retractable with 12 " Sleeve & 7" Boot

SB-R2LB	Seat Belt with Lift Latch	Black
SB-R2LG	Seat Belt with Lift Latch	Grey
SB-R2LM	Seat Belt with Lift Latch	Maroon
SB-R2LN	Seat Belt with Lift Latch	Navy Blue
SB-R2LR	Seat Belt with Lift Latch	Red
SB-R2LT	Seat Belt with Lift Latch	Tan

3 Points Retractable Shoulder Belt



SB-R3LB	Retractable 3 Point Seat Belt with Chrome Latch	Black
SB-R3PB	Retractable 3 Point Seat Belt with Push Button	Black
SB-R3PG	Retractable 3 Point Seat Belt with Push Button	Grey
SB-R3PT	Retractable 3 Point Seat Belt with Push Button	Tan
SB-R3PN	Retractable 3 Point Seat Belt with Push Button	Navy Blue
SB-R3PR	Retractable 3 Point Seat Belt with Push Button	Red

Seat Components

3641RN
1966-77 Front Seat Bottom Spring, RH=LH

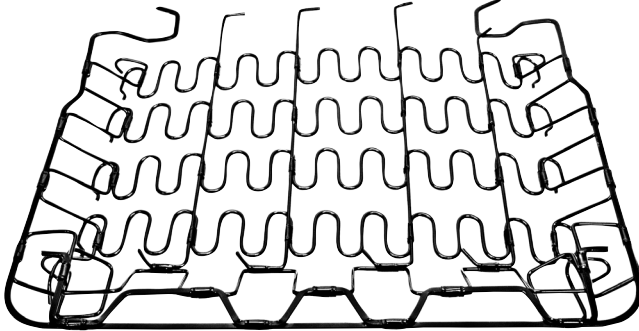

3775
1966-77 Front Seat Back Spring, RH=LH

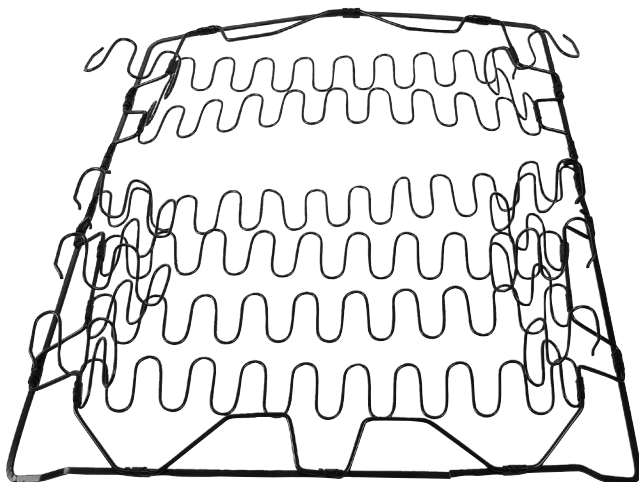

3772
1966-77 Seat Frame Assembly, RH

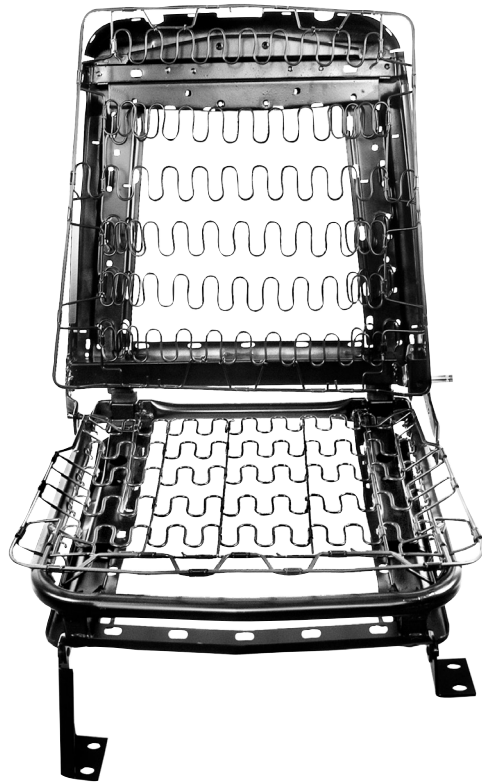

3773
1966-77 Seat Frame Assembly, LH
Left Seat Includes Track / Adjuster Assembly.

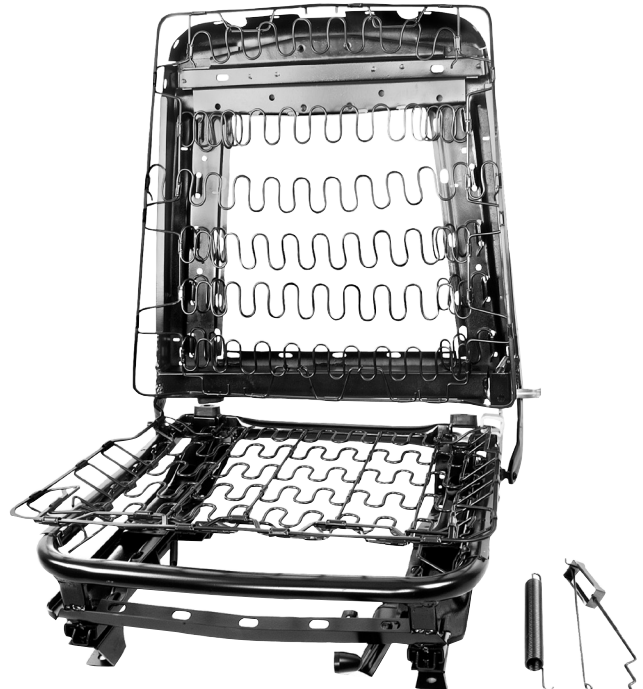

Seat Components

M3638
1966 Seat Side Molding RH
(Modify for 1967-69)

M3639
1966 Seat Side Molding LH
(Modify for 1967-69)



3777A
1966-77 Rear Seat Arm Rest, Pair, Black



3777B COMING SOON!
1966-77 Rear Bench Seat Form, 2 Pcs.



3115M
1968-77 Arm Rest, Black, RH

3115N
1968-77 Arm Rest, Black, LH



3115M

3774
1968-77 Seat Track Assembly, Driver's Side Only

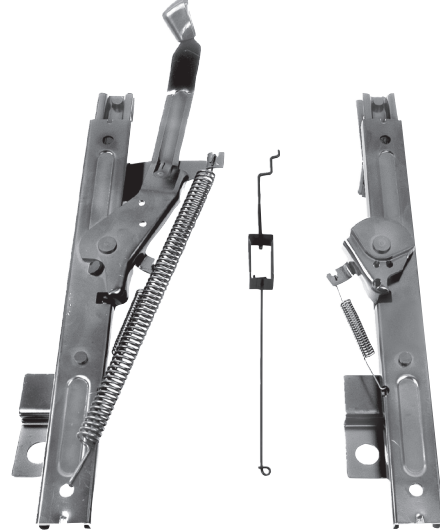

3641RR NEW
1966-67 Seat Frame Bottom, RH



3641R NEW
1966-67 Seat Frame Bottom, LH



Interior Electrical

M33900

1966-77 Horn Set w/ Brackets



Locks

CL-4877

1966-77 Ignition & Door Lock Set,
Standard Ford Head Keys



CL-1401

1966-77 Ignition Lock Set, Small Head Keys

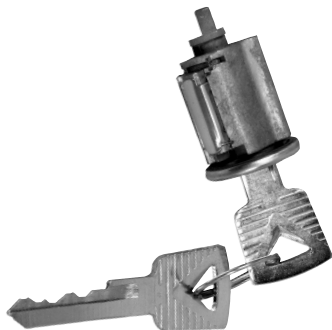

CL-1555

1978-79 Ignition & Door Locks, Large Head Keys



CL-1402

1978-79 Ignition Lock Set, Large Head Keys



CL-1550

1978-80 Door Locks, Large Head Keys



CL-300

1966-77 Door Locks, Small Logo Head Keys

