

*Golden Leaf
Automotive*



2023

EL CAMINO

El Camino Index

A

Accelerator Pedal: 52
Accelerator Pedal Trim: 52
A/C Center Vent: 18
A/C Cowl Vent Actuator: 51
A/C Heater Box Assembly: 51
A/C & Heater Control: 51
A/C Plenum: 51
A/C Vent Ball: 18
Accelerator Bracket: 6
Accelerator Pedal Assembly: 53
A/C Vent Bezel: 18
Alternator & Accelerator Brackets: 6
Antennas: 49
Arm Rest Bases: 57

B

Back Up Lamp Assembly: 48
Backup Lamp Lenses: 48
Back Up Lenses: 48
Battery Tray: 5
Battery Tray Clamp: 5
Bed Floor Pans & Components: 21, 22
Bed Front Lift Panel: 25
Bed Front Lift Panel Support: 25
Bed Moldings: 43, 44
Bed Panels: 25
Bed Rear Cross Bar: 22
Bed Roll Pan: 22
Bed to Quarter Panel Filler: 28
Belt Buckle Covers: 61
Big Block Alternator Bracket: 6
Billet Hood Hinge: 9, 10
Body Shims & Washers: 7
Body Side Mldgs. & Clips: 42, 43
Brake Release Handles: 52
Bucket Seat Release Button: 61
Bumper Filler: 2
Bumpers: 1, 2
Bumper Brackets: 3
Bumper Reflectors: 49
Bumper Reinforcement: 2
Bushings: 64

C

Center Shroud: 54
Cigarette Lighter: 63
Clothes Hanger: 58
Clutch Rod Boot: 54
Column Cover, Lower: 18
Complete Floor Pan: 20
Console Clock Acrylic Lens: 17
Console Door Top Plate: 53
Console Mounted Clock: 17
Console Shift Boot Retainer: 54
Console Trans. Indicator Insert: 53
Control Arm Bumper: 7

Control Arms: 6, 7
Cowl Panels: 17
Cowl Shoulder Assembly: 17

D

Dash Ash Tray: 18
Dash Assembly: 19
Dash Gauge Backing Plate: 17
Dash Panels & Components: 17, 18, 19
Divider Panel: 25
Dome Light Lens: 64
Door Accessories: 33
Door Bumpers: 57
Door Edge Moldings: 56
Door Frame Moldings: 56
Door Frame Weatherstrip: 50
Door Glass Stopper: 31
Door Handles: 31, 32
Door Hinges: 30
Door Inner Handle: 32
Door Jamb Vent Grille: 57
Door Jamb Vent Grille & Bumpers: 57
Door Latches: 30
Door Lock Knobs: 57
Door Lock Striker: 31
Door Outer Handle: 32
Door Scuff Plates: 58
Doors & Hardware: 29, 30, 31, 32
Door Shell: 29
Door Sill Decal: 65
Door Sill Scuff Plates: 58
Door Skin: 29
Door Trims & Arm Rests: 56, 57
Door Window Frame: 31
Door Window Glass: 50
Door Window Guide Plates: 31
Door Window Guide Stabilizers: 31
Drip Rail Molding: 41

E

Emblems: 45, 46
Engine Compartment: 5, 6
Engine Mounts: 5, 6
Evaporator Box: 51
Exterior Electrical & Components: 46, 47, 48, 49
Exterior Mirrors: 40
Eyebrow Moldings: 36

F

Fan: 5
Fender Extension, Front: 9
Fenders, Front: 7, 8
Fenders, Front Inner: 9
Fender Patch Panels: 9
Firewall Brackets: 16
Firewalls Brackets: 16

Firewalls & Components: 16, 17
Firewall Wiper Plate: 17
Floor Pans & Components: 19, 20
Floor Pan Supports: 19
Front Door Glass Channel Support: 31
Front Fenders: 7, 8
Front Inner Fenders: 9
Fuel Cap: 24
Fuel Senders: 23, 24
Fuel Sending Unit, Gasket: 24
Fuel Sending Unit, Locking Ring: 24
Fuel Tank Braces & Straps: 24
Fuel Tanks: 22, 23
Full Floor Pan: 19

G

Galvanized Floor Plug: 19
Gas Filler Door: 24
Gasket: 24
Glass & Weatherstripping: 49, 50
Glove Box Door: 18
Glovebox Locks: 67, 68
Grille Extension Moldings: 36
Grille Extensions: 38
Grille Molding: 36, 37
Grilles & Components: 33, 34, 35, 36, 37, 38

H

Header Molding: 39
Header Panels: 4
Headlamp Bezels: 35
Headlamp Door Bezel: 38
Headlamp Mounting Buckets: 35
Headlamp Retaining Rings: 35
Headlamp Switches: 63
Headliner Clips: 29
Headliner Mldg.: 56
Heater Blower Motor: 51
Heater Box: 51
Heating/Cooling Components: 51
Hood Catch: 12
Hood Hinge: 9, 10
Hood Hinge Spring: 10
Hood Latch Support: 11, 12
Hood Louver Inserts: 12
Hood Louvers: 12
Hood Pins: 12
Hood Pins w/ Hardware: 12
Hoods & Components: 9, 10, 11, 12, 13, 14, 15
Hood Bumpers: 12
Hood Catch & Spring: 12
Hood Latches: 10, 11
Hood Latch Supports: 11, 12
Hood Lip Molding: 39
Hood Moldings & Spears: 39
Horns: 63

I

Ignition, Door & Glovebox Locks: 65, 66
Ignition & Door Lock Kits: 68, 69
Ignition Locks: 66, 67
Ignition Switch Bracket: 18
Inner Quarter Panel: 28
Inner Quarter Panel & Bed Components: 28
Instrument Bezel: 18
Instrument Cluster Lens: 18
Instrument Housing Kits: 18
Interior Door Handle: 32
Interior Electrical: 62, 63, 64
Interior Hooks: 58

K

Kick Panels: 59

L

Lap Cooler: 51
License Plate Bracket, Rear: 24
License Plate Lamp: 49
Locks: 65, 66, 67
Lower Control Arm: 6, 7
Lower Outer Grille Molding: 36

M

Magnum Alloy Wheels: 61
Manual Regulator: 31
Mirror Mounting Kit: 40
Mirrors, Exterior: 40
Mirrors, Interior: 55, 56

O

Outer Grille Extensions: 38

P

Parking Brake Controls: 52
Parking Brake Pad: 52
Parking Brake Pad Trim: 52
Parking Lamp Assembly: 46
Parking Lamp Bezels: 49
Parking Lamp Lenses: 46, 47
Pedal Pads & Trim: 52, 53, 54
Pedal & Shifter Components: 52, 53
Push Button Kit: 31

Q

Quarter Panel Patch, Lower: 27
Quarter Panels: 27
Quarter Window Regulator: 31

R

Radiator Bridge Plate: 5
Radiator Fan Shroud: 5
Radiator Supports & Brackets: 4, 5
Radios & Components: 62
Rear Bed Corners: 44
Rear Cab Panel: 25
Rear Seat Floor Pan: 19
Rear View Mirror Bracket: 56
Rear View Mirror Bracket Boot: 56
Rear Window Shelf Panel: 25
Rocker Mldgs.: 43
Rocker Panels: 22
Roof Inner Brace Kit: 29
Roof Panel & Braces: 29
R. View Mirrors, Visor Supports: 55, 56
R. Window Mldgs.: 43

S

Scuff Plate: 58
Seat Back Spring: 60
Seat Belts: 62
Seat Bottom Spring: 60
Seat Frames & Springs: 59, 60, 61
Seats & Components: 59, 60, 61
Seat Side Support Spring: 60
Seat Track Assembly: 60
Shift Assembly: 53
Shift Base: 53
Shifter Levers: 53
Shoulder Harness Hooks: 58
Sill Decal: 65
Smuggler's Box Panel: 25
Speedometer Cable Grommet: 18
Spindle Kit: 7
Steering Column Clamp Plates: 17
Steering Column Cover: 18
Steering Wheel: 55
Steering Wheel Hubs: 54
Sun Visor Support Bracket: 56
Suspension: 6, 7

T

Tachometer: 17
Tailgate Cables & Springs: 26
Tailgate Handle: 26
Tailgate Hinges: 26
Tailgate Inner Panel Set: 26
Tailgate Latch Set: 26
Tailgate Outer Skin: 25
Tailgates & Components: 25, 26
Tailgate Shell: 25
Tailgate Molding: 44
Tail Lamp Housing: 49
Tail Lamp Mounting Panel: 28
Tail Lamps: 48
Tail Lamp Lenses: 47, 48

Transmission Tunnel Plate: 19, 20
Trim Panels: 58

U

Under Headlamp Molding: 36
Upper Control Arm: 6
Upper Grille Plate: 38
Upper Radiator Plate: 38
Upper Radiator Support Plate: 5

V

Vent Window Actuator: 33
Vent Window Cranks: 33
Vent Window Handles: 33
Vinyl Top Moldings: 43

W

Wheel Center: 42
Wheel Center Retainer: 42
Wheel Center Shroud: 54
Wheelhouses: 27
Wheel Opening Moldings: 41, 42
Window Crank Gaskets: 32
Window Cranks: 32
Window Moldings, Rear: 43
Windshield Channels & Pillars: 15
Windshield Glass: 50
Windshield Moldings: 40, 41
Windshield Pillar/A-Pillar/Rocker Assy.: 22
Windshield Washer Bottle Bracket: 6
Wiper Motor Transmission Arms: 39



General Motors Trademarks
are used under License to
Dynacorn International Inc.

Bumper

1457

1964 Front Bumper, Premium Quality



New Chrome Process

1458

1964 Rear Bumper, Premium Quality



New Chrome Process

1459

1965 Front Bumper, Premium Quality



New Chrome Process

1460

1965 Rear Bumper, Premium Quality



New Chrome Process

1460A

1966 Front Bumper, Premium Quality



New Chrome Process

1460C

1967 Front Bumper, Premium Quality



New Chrome Process

1460E

1968 Front Bumper, Premium Quality



New Chrome Process

1460N

1968-72 Rear Bumper, Premium Quality



New Chrome Process

1460G

1969 Front Bumper, Premium Quality



New Chrome Process

1460R

1970 Front Bumper, (Also Fits Monte Carlo)



New Chrome Process

Bumper

1460L
1971-72 Front Bumper, Premium Quality



New Chrome Process

1460Z
1978-87 Front Bumper, w/o Pad Holes



1460P
1978-87 Rear Bumper, w/o Pad Holes



1460Q
1978-87 Rear Bumper, w/ Pad Holes



Bumper Reinforcement

1490X
1965 Front Bumper Filler Panel



1491A
1966 Bumper Filler



1491
1967 Bumper Filler



1492
1968 Bumper Filler



1492A
1969 Bumper Filler



1493
1970 Bumper Filler



1460ZA
1978-87 Bumper Reinforcement



Bumper Brackets

1408B

1964 Front Bumper Brackets, 4 Pcs.



1411F

1965 Front Bumper Brackets, 4 Pcs.



1408D

1966 Front Bumper Brackets, 4 Pcs.



1408E

1967 Front Bumper Brackets, 4 Pcs.



1408C

1966-67 Rear Bumper Brackets, 4 Pcs.



1411I

1968 Front Bumper Brackets, 4 Pcs.



1410

1968-72 Rear Bumper Brackets, 7 Pcs.



1411J

1969 Front Bumper Brackets, 4 Pcs.



1411K

1970 Front Bumper Brackets, 4 Pcs.



1411R

1971-72 Front Bumper Brackets, 8 Pcs.



Header Panels

1468H
1968-69 Header Panel



1461
1982-87 Header Panel



1488B
1967 Radiator Support



1488C
1968-69 Radiator Support



Radiator Supports & Brackets

1488
1965 Radiator Support



1488E
1970 Radiator Support



1488A
1966 Radiator Support



1488D
1971-72 Radiator Support



Radiator Supports continued on next page

Radiator Supports & Brackets

1488L
1968-72 Radiator Bridge Plate,
Small Block



1488P
1970-72 Upper Radiator Support Plate



Engine Compartment

1488H
1964-65 Battery Tray



1068K
1966 Battery Tray



1488J
1967 Battery Tray



1488K
1968-72 Battery Tray,
(Also Fits Monte Carlo)



M1723
1964-65 Battery Tray Clamp



1047E
1966-77 Battery Tray Clamp



1047EC
1966-72 Battery Tray Clamp, Stainless



1487W
1964-65 Radiator Fan Shroud

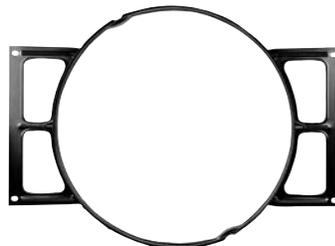

1488W
1966-67 Radiator Fan Shroud, Small Block

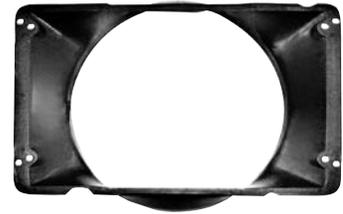

1488X
1966-67 Radiator Fan Shroud, Big Block



1488Y
1968 Radiator Fan Shroud, Big Block

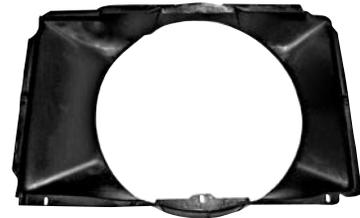

M1017
1968-72 Fan, 7 Blade



1427A
1964-67 Engine Mounts, Small Block



Engine Compartment

1426

1966-67 Engine Mounts, Big Block



1427

1968-72 Engine Mounts, V8



1425

1964-69 Windshield Washer Bottle Bracket



1392

1965-68 Alternator Bracket, Big Block



1047G

1969-72 Accelerator Bracket, Holley Only



Suspension

1495MD

1964-72 Upper Control Arm, (Tubular Style) RH, w/ Drop
Use 1495MD w/ 1495PD

1495ND

1964-72 Upper Control Arm, (Tubular Style) LH, w/ Drop
Use 1495ND w/ 1495QD



1495M

1964-72 Upper Control Arm, RH (Tubular)

1495N

1964-72 Upper Control Arm, LH (Tubular)



1495G

1966-72 Upper Control Arm, RH, (OE)

1495H

1966-72 Upper Control Arm, LH, (OE)



1495PD

1964-72 Lower Control Arm, (Tubular Style) RH, w/ Drop
Use 1495PD w/ 1495MD

1495QD

1964-72 Lower Control Arm, (Tubular Style) LH, w/ Drop
Use 1495QD w/ 1495ND



1495P

1964-72 Lower Control Arm, RH (Tubular)

1495Q

1964-72 Lower Control Arm, LH (Tubular)



1495J

1964-72 Lower Control Arm, RH, (OE)

1495K

1964-72 Lower Control Arm, LH, (OE)



Suspension

1495E
1964-72 Rear Lower Control Arms



1495D
1964-67 Rear Upper Control Arm, (A Body), Pair



1007
1964-72 Upper Control Arm Bumper



1007A
1964-72 Lower Control Arm Bumper



Body Shims

1000E
1964-72 Body Shims, 1.6 mm, 10 Pcs.

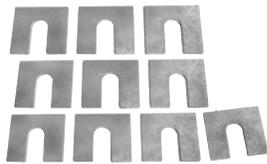

1000D
1967-72 Body Shims, 3 mm, 10 Pcs.



1000F
1964-72 Body Shims, 6 mm, 10 Pcs.



Spindle Kit

1003C
1964-72 Spindle Kit w/ Disc Brake Hardware



Front Fenders

1475W
1965 Front Fender, RH

1475X
1965 Front Fender, LH



Front Fenders

1476
1966 Front Fender, RH

1477
1966 Front Fender, LH



1478
1967 Front Fender, RH

1479
1967 Front Fender, LH



1479A
1968 Front Fender, RH

1479B
1968 Front Fender, LH



1479C
1969 Front Fender, RH

1479D
1969 Front Fender, LH



1483E
1970 Front Fender, RH

1483F
1970 Front Fender, LH



1483G
1971-72 Front Fender, RH

1483H
1971-72 Front Fender, LH



1483A
1978-81 Front Fender, RH

1483B
1978-81 Front Fender, LH



1483C
1982-87 Front Fender, RH

1483D
1982-87 Front Fender, LH



Front Inner Fenders

1471N
1965 Front Inner Fender, RH
1471P
1965 Front Inner Fender, LH



1472B
1967 Front Inner Fender, RH
1472C
1967 Front Inner Fender, LH



1472D
1968-72 Front Inner Fender, RH
1472E
1968-72 Front Inner Fender, LH



1472
1966 Front Inner Fender, RH
1472A
1966 Front Inner Fender, LH



1472T
1968-72 Plastic Front Inner Fender, RH
1472U
1968-72 Plastic Front Inner Fender, LH



Fender Extension

1481A
1970 Fender Extension, RH
1481B
1970 Fender Extension, LH



Fender Patch Panels

1475WA
1964-65 Fender Patch Panel, Lower Rear, RH
1475XA
1964-65 Fender Patch Panel, Lower Rear, LH

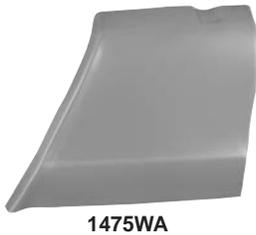

1476A
1966-67 Fender Patch Panel, Lower Rear, RH
1477A
1966-67 Fender Patch Panel, Lower Rear, LH



1479E
1968-69 Fender Patch Panel, Lower Rear, RH
1479F
1968-69 Fender Patch Panel, Lower Rear, LH



Hoods & Components

BH30
1964 Billet Hood Hinge, Pair



BH01
1965-67 Billet Hood Hinge, Pair

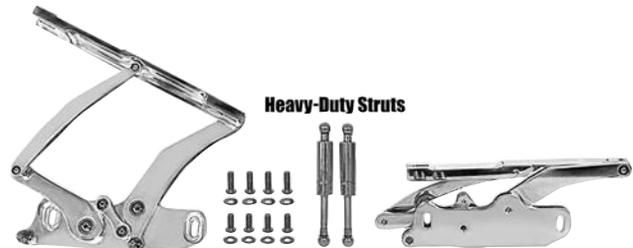

Hoods & Components

BH12

1968 Billet Hood Hinge, Pair

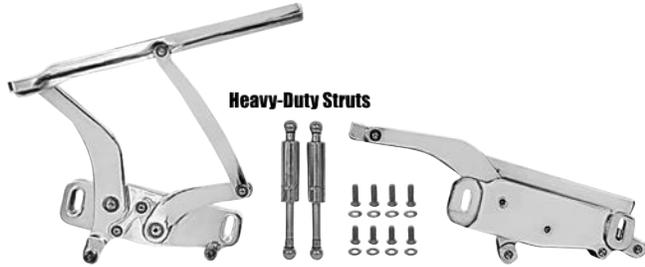

BH13

1969-72 Billet Hood Hinge, Pair



1701A

1964 Hood Hinge, RH

1701B

1964 Hood Hinge, LH



1464Y

1968 Hood Hinge, RH

1464Z

1968 Hood Hinge, LH



1466

1970-72 Hood Hinge, RH

1467

1970-72 Hood Hinge, LH



1068G

1965-67 Hood Hinge, RH

1068H

1965-67 Hood Hinge, LH



1464

1969 Hood Hinge, RH

1465

1969 Hood Hinge, LH



1069AY

1964-72 Hood Hinge Spring



1488UB

1965 Hood Latch



*Hood Latch
continued on next page*

Hoods & Components

1099MG NEW
1978-87 Hood Latch



Reverse View



1488UA
1968 Hood Latch



1488Q
1966 Hood Latch Support



1488ZA
1966 Hood Latch



1488Z
1970-72 Hood Latch



1488R
1967 Hood Latch Support



1488U
1967 Hood Latch



1488QA
1965 Hood Latch Support



1488RA
1968 Hood Latch Support



Hoods & Components

1488S
1969 Hood Latch Support



1488T
1970 Hood Latch Support
(Also fits 1970-72 Monte Carlo)



1488G
1971-72 Hood Latch Support



1488V
1966 Hood Catch



1488F
1970-72 Hood Catch & Spring



1468F
1964-66 Hood Bumpers



1468C
1966 "SS" Hood Louvers



1468D
1966 Hood Louver Inserts

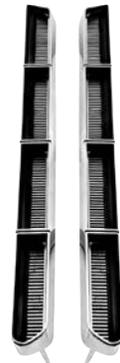

M1379
1969 "SS" Hood Louvers



1470A
1970-72 "SS" Hood Pins w/ Hardware

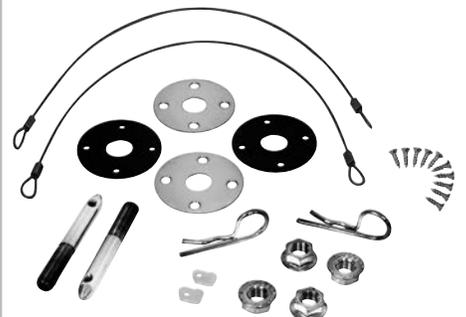

Hoods & Components

1468A
1966 Standard Hood



1468B
1966 "SS" Hood



1468K
1966 Cowl Induction Hood



1468G
1967 Cowl Induction Hood



Hoods & Components

1468
1967 "SS" Hood



1468L
1968-69 Cowl Induction Hood (Use 1969 Hinges)



1469
1968-69 "SS" Hood (Fits 1968 w/ 1969 Hinges)



1471
1970-72 Cowl Induction Hood



Hoods continued on next page

Hoods & Components

1470
1970-72 "SS" Hood



1471A
1978-87 Standard Hood

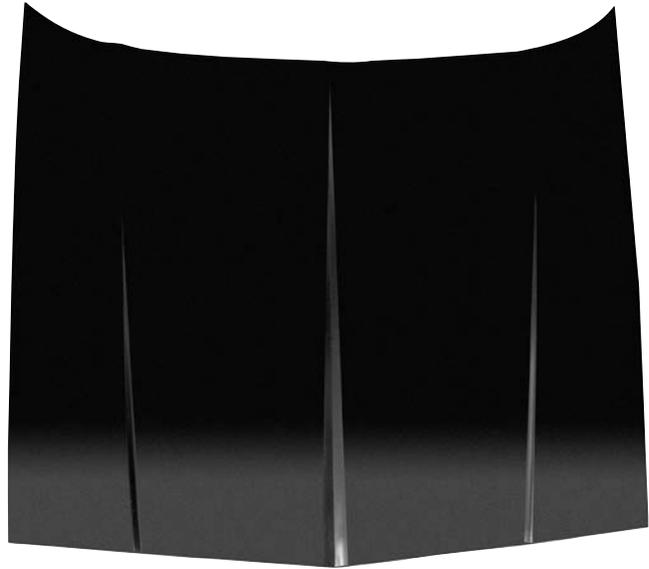

1471D
1978-87 Cowl Induction Hood, 2"



1½" Cowl Closeup



Reverse View

Windshield Channels & Pillars

1490DWT
1964-67 Windshield Channel, Weld-Through Primer



M1424BWT
1968-72 Windshield Channel, Weld-Through Primer



1461J
1966-67 Windshield Pillar Wrap, RH, Coupe

1461K
1966-67 Windshield Pillar Wrap, LH, Coupe



1461K

Firewalls & Components

1461I
1964-67 Firewall w/ Heater



1461IA
1964-67 Firewall, Heater Delete



1461A
1968-72 Firewall w/ A/C, Weld-Through Primer

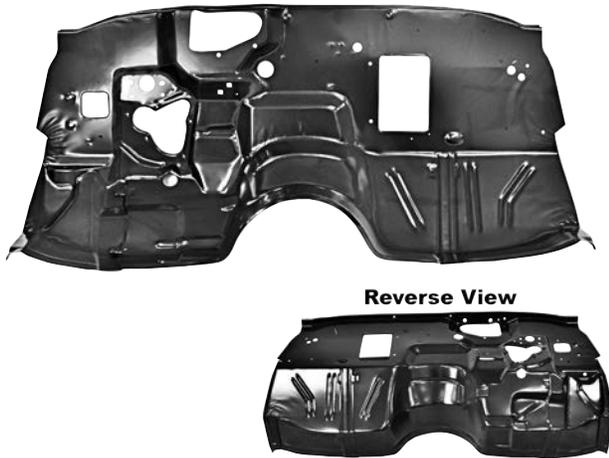

1461C
1968-72 Firewall w/ Heater Delete, Weld-Through Primer

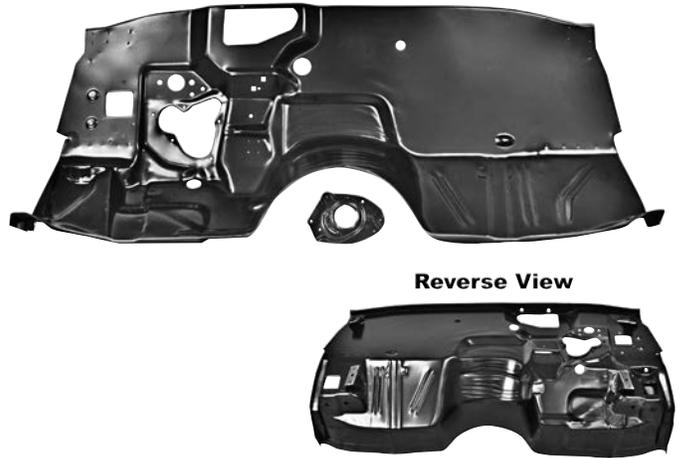

1461B
1968-72 Firewall w/o A/C, Weld-Through Primer

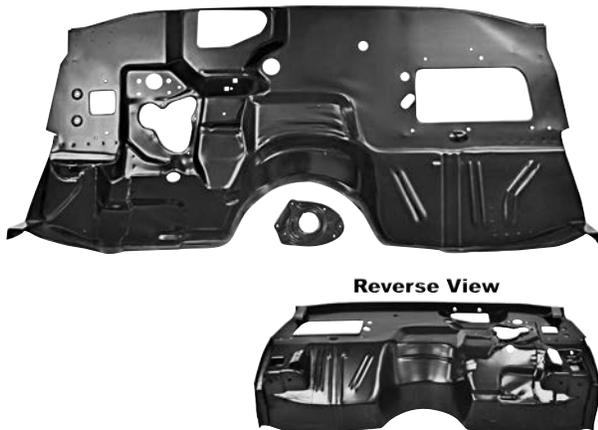

1461F
1968-72 Firewall Brackets, EDP Coating

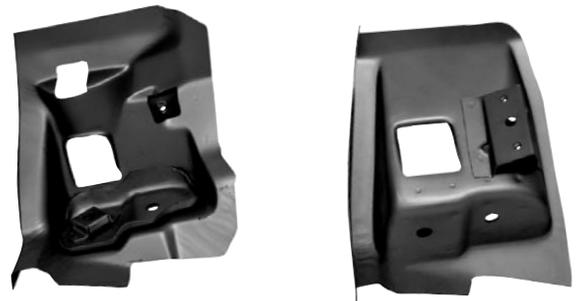

Firewalls & Components

1461G
1968-69 Firewall Wiper Plate



1400L
1968-72 Steering Column Clamp Plates
Automatic Transmission



Cowl Panels

1419A
1968-69 Lower Cowl Panel, EDP Coating



1419EWT
1968-72 Outer Cowl Panel,
Weld Through Primer, RH

1419FWT
1968-72 Outer Cowl Panel,
Weld Through Primer, LH



Dash Panels & Components

1419CWT
1968-72 Cowl Shoulder Assembly,
Weld Through Primer, RH

1419DWT
1968-72 Cowl Shoulder Assembly,
Weld Through Primer, LH



1451X
1964-65 Dash Gauge Backing Plate



1452C
1970-72 Dash Gauge Backing Plate



1400A
1966-67 Console Mounted Clock



1400B
1966-67 Console Clock Acrylic Lens



1400R
1966 Tachometer, Chrome 5600 Red-line



1400S
1966 Tachometer, Chrome 6200 Red-line



1400T
1967 Tachometer, Black 5500 Red-line



1400U
1967 Tachometer, Black 6000 Red-line



Dash Panels & Components

M1359B

1966-67 Instrument Bezel



1452D

1970 Instrument Housing Kit (Green Reverse), "SS", 3 Pcs.



Reverse View

1452E

1971-72 Instrument Housing Kit (Light Blue Reverse), "SS", 3 Pcs.



Reverse View

1452F

1970-72 Instrument Cluster Lens



3856472

1966-67 A/C Vent Ball, Chrome



K851

1966-69 A/C Vent Bezel



1452K

1968-72 A/C Center Vent, Black w/ Trim



1452J

1969-72 A/C Center Vent, Chrome



1403C

1964-72 Speedometer Cable Grommet



1498D

1968-72 Ignition Switch Bracket



1454

1970-72 Glove Box Door



1453

1970-72 Dash Ash Tray



1451D

1969 Steering Column Cover



1451H *COMING SOON!*

1968 Dash Steering Column Cover



1451G

1970-72 Lower Column Cover, "SS" w/ Round Speedometer & Gas Gauge Holes



Dash Panels & Components

1451A

1969 Dash Assembly w/o Astro-Ventilation or A/C Instrument Carrier



1451B

1969 Dash Assembly w/ Astro-Ventilation, w/o A/C Instrument Carrier



1451C

1969 Dash Assembly w/ A/C Instrument Carrier



1452

1970-72 Dash Assembly w/ 3-Vent Register (*SS* Only)



1455

1968 Steel Dash Panel, EDP Coating



D14810 **NEW**

1970-72 Dash Pad w/ Vent



Floor Pans & Components

1461ZA

1964-67 Under Floor Pan Support, Rear



1462L

1968-69 Rear Seat Floor Pan

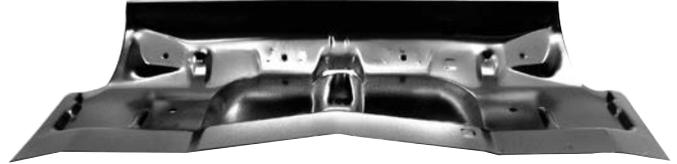

1462J

1968-72 Full Floor Pan, RH

1462K

1968-72 Full Floor Pan, LH

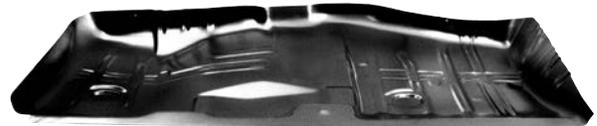

1047F

1964-72 Galvanized Floor Plug



1462WB

1964-67 Transmission Tunnel Plate, w/ Console



1462WC

1964-67 Transmission Tunnel Plate, w/o Console



Floor Pans & Components

1425A

1968-72 Transmission Tunnel Plate, Standard Shift w/o Console



1462WD

1968-72 Transmission Tunnel Plate, w/ Console Manual Transmission



1462WE

1968-72 Transmission Tunnel Plate, w/o Console Manual Transmission



1462ZB

1968-69 Complete Floor Pan



1462WA

1964-67 "A" Body Complete Floor Pan Includes Front, Center & Rear Under Floor Pan Supports, Rear Seat Floor Pan.



1462ZCWT

1968-69 Complete Floor Pan w/ Inner Rocker Panels, Weld Through Primer

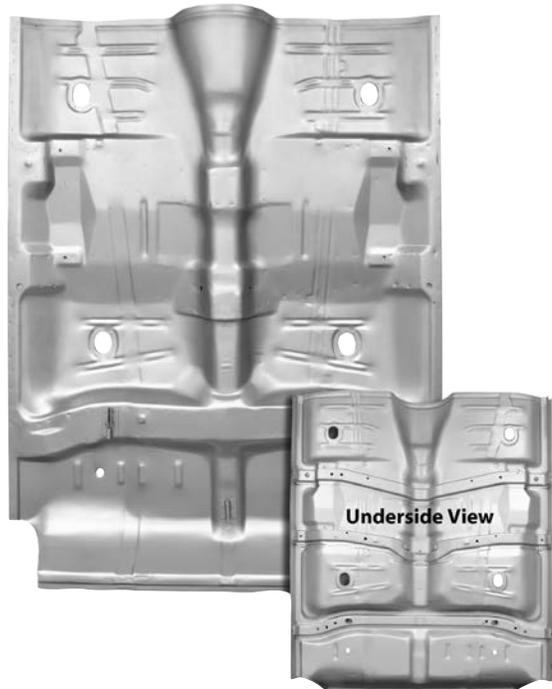

Bed Floor Pans & Components

1428H

1968-72 Complete Bed Floor Pan Including Under Supports

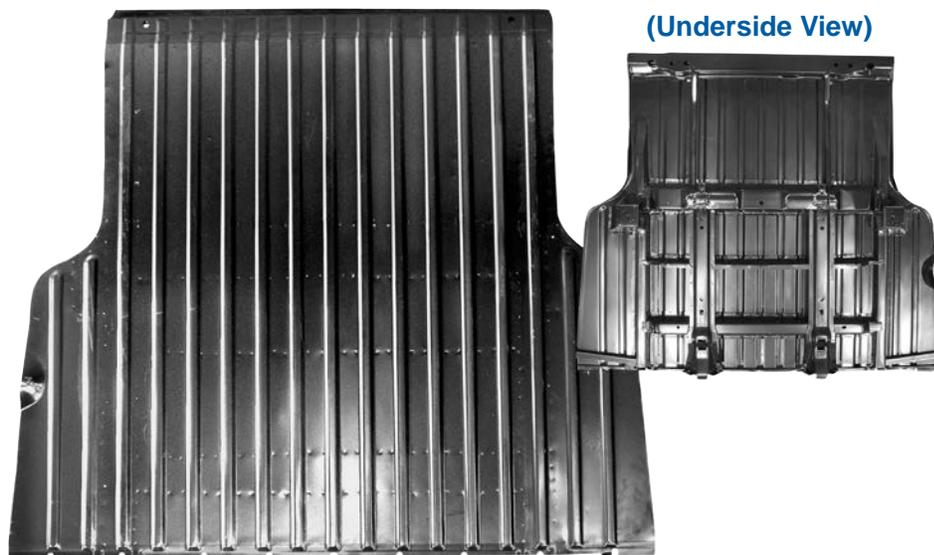

1428L

1968-72 Complete Bed Floor Pan Including Under Supports and Roll Pan



Bed Floor Pans & Components

1428JWT

1968-72 Bed Rear Cross Bar, Weld Through Primer



1428K

1968-72 Bed Roll Pan



Rocker Panels

1489BA

1968-72 Rocker Panel, RH

1489BB

1968-72 Rocker Panel, LH



1489BA

Windshield & A-Pillar/Rocker Assembly

1475GEWT

1968-72 Windshield Pillar / A-Pillar / Rocker Assembly, RH

1475HEWT

1968-72 Windshield Pillar / A-Pillar / Rocker Assembly, LH

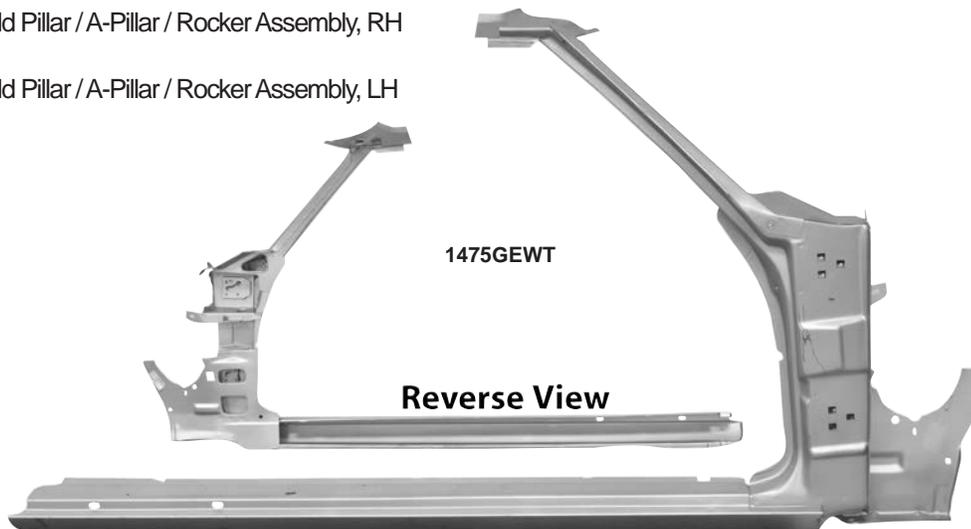

Does Not Qualify For Free Freight Program

Fuel Tanks

T32

1964-67 Galvanized Tank w/o Fuel Cap Flange



T33

1968-70 Galvanized Fuel Tank w/o EEC



Fuel Tanks continued on next page

Fuel Tanks

T35

1970-72 Galvanized Fuel Tank w/ EEC



T35C

1978-87 Galvanized Fuel Tank, 22 Gallon



T35A

1973-74 Galvanized Fuel Tank w/ Neck, 26 Gallon



T35D

1978-87 Galvanized Fuel Tank, 17 Gallon



T35B

1975-77 Galvanized Fuel Tank w/ Neck, 26 Gallon



Fuel Senders

T70

1964 Fuel Sending Unit, 5/16"



T71

1964-67 Fuel Sending Unit, 3/8"



Fuel Senders

T72
1968-70 Fuel Sending Unit,
V-8 350, 400, 454, 396 4bbl w/A/C



T73
1971-72 Fuel Sending Unit,
V-8 350 4bbl w/A/C, 400 2bbl, 454 4bbl



T20
1964-72 Fuel Sending Unit, Locking Ring



T21
1964-72 Fuel Sending Unit, Gasket



Gas Filler Door

1475HT
1964-67 Gas Filler Door



1475L
1968-72 Gas Filler Door



Fuel Tank Braces & Straps

T13M
1964-67 Fuel Tank Straps

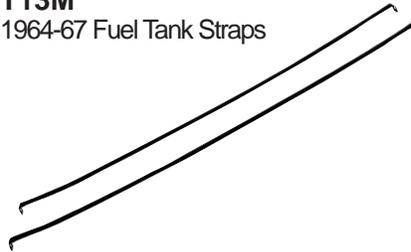

T35E NEW
1978-87 Gas Tank Strap, 2 Pcs.



1462PA
1968-72 Fuel Tank Braces



Fuel Cap

T46
1964-70 Gas Cap Vented



T32A
1964-72 Gas Cap, Not Vented



Lic. Plate Bracket

1424B
1964-72 Rear Bracket
(Also '68-'72 Chevelle)



License Plate Frames

LF64
1964 License Plate Frames

LF71
1971 License Plate Frames

LF72
1972 License Plate Frames

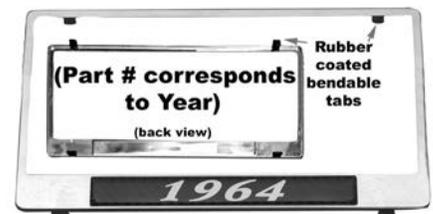

**WHILE
SUPPLIES
LAST!**

Bed Panels

1428FWT

1964-67 Divider Panel w/ Cut-Outs, Weld-Through Primer



1428D

1968-72 Rear Window Shelf Panel



1428B

1968-72 Rear Cab Panel



1428A

1968-72 Smuggler's Box Panel



1428G

1964-67 Bed Front Lift Panel Support



1428C

1968-72 Bed Front Lift Panel



Tailgates & Components

1490

1964-66 Tailgate Outer Skin w/ Holes



1490A

1967 Tailgate Outer Skin w/o Holes



1490B

1968 Tailgate Outer Skin w/ Backup Light



1490C

1969-72 Tailgate Outer Skin w/ Back Up Light



1429D

1964-67 Tailgate Shell



Tailgates & Components

1429E

1964-67 Tailgate Inner Panel Set



1429B

1968-72 Tailgate Inner Panel Set, 9 Pcs.

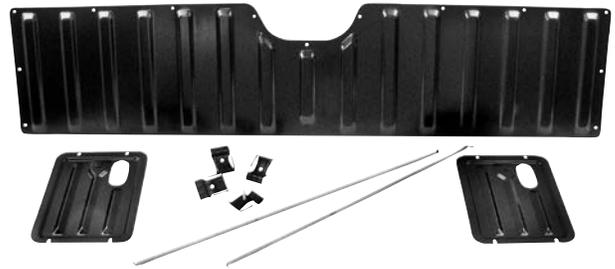

1428

1968 Complete Tailgate w/o Backup Light Holes



1429

1969-72 Complete Tailgate w/ Backup Light Holes



1490E

1964-72 Tailgate Cable Springs



1490F

1973-87 Tailgate Cable Springs



1429C

1968-77 Tailgate Cable Assembly w/ Hardware, Pair



1490H

1968-72 Tailgate Hinges



1490G

1968-72 Tailgate Handle w/ Nylon Washer



1429A

1968-72 Tailgate Latch Set

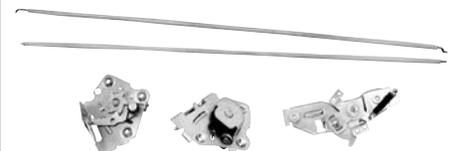

Quarter Panels

1475HM

1964-65 Full Quarter Panel, RH

1475HN

1964-65 Full Quarter Panel, LH



1475HL

1978-87 Full Quarter Panel, LH

WHILE SUPPLIES LAST!



1475GWT

1968-72 Full Quarter Panel, Weld-Through Primer, RH

1475HWT

1968-72 Full Quarter Panel, Weld-Through Primer, LH



1475GE

1968-72 Lower Quarter Panel Patch, RH

1475HE

1968-72 Lower Quarter Panel Patch, LH



Wheelhouses

1472K

1968-72 Rear Outer Wheel House, RH

1472L

1968-72 Rear Outer Wheel House, LH



1475HF

1973-77 Quarter Panel Skin, RH

1475HG

1973-77 Quarter Panel Skin, LH



1472M

1968-72 Complete Wheelhouse, RH, (Inner & Outer)

1472N

1968-72 Complete Wheelhouse, LH, (Inner & Outer)



Inner Quarter Panel & Bed Components

1475GC

1968-72 Complete Inner Quarter Panel, RH

1475HC

1968-72 Complete Inner Quarter Panel, LH



1475GA

1968-72 Inner Quarter Panel, RH

1475HA

1968-72 Inner Quarter Panel, LH



1475GB

1968-72 Front Inner Quarter Panel, RH

1475HB

1968-72 Front Inner Quarter Panel, LH



1475HP

1964-67 Bed to Quarter Panel Filler, RH

1475HQ

1964-67 Bed to Quarter Panel Filler, LH



1462Q

1968-72 Bed to Quarter Panel Filler, RH

1462R

1968-72 Bed to Quarter Panel Filler, LH



Tail Lamp Mounting Panel

1475HR

1964-65 Tail Lamp Mounting Panel, RH

1475HS

1964-65 Tail Lamp Mounting Panel, LH



1423A

1968-72 Tail Lamp Mounting Panel, RH

1423B

1968-72 Tail Lamp Mounting Panel, LH



Roof Panel & Braces

1428EWT

1968-72 Roof Panel, Weld-Through Primer



1428EA

1968-72 Roof Panel Brace, EDP Coating



1418T

1968-72 Roof Inner Brace Kit

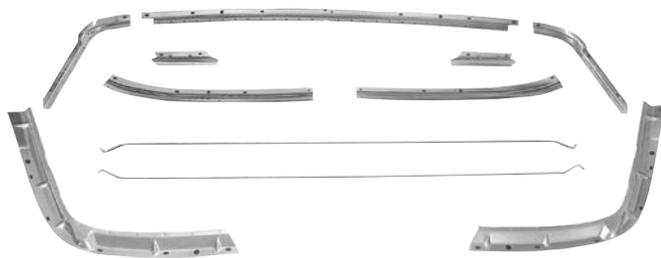

M1418M

1968-72 Headliner Clips, 6 Pcs. / Kit, Large

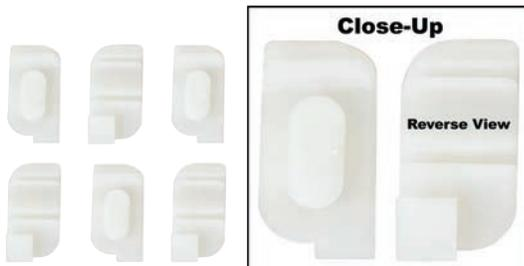

Doors & Hardware

1487A

1964-65 Door Skin, RH

1487B

1964-65 Door Skin, LH

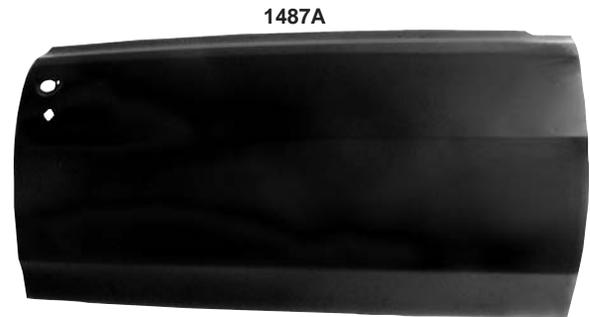

1484

1966-67 Door Skin, RH

1485

1966-67 Door Skin, LH

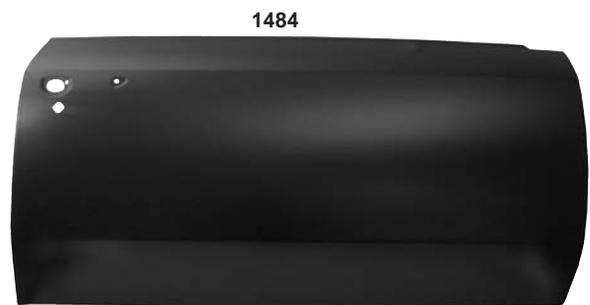

1485A

1966-67 Door Shell, RH

1485B

1966-67 Door Shell, LH



Doors & Hardware

1542
1964-65 Door Latch, RH
1543
1964-65 Door Latch, LH



CH134
1969 Door Latch, RH
CH133
1969 Door Latch, LH



1556Y
1966-67 Door Hinge, Upper, RH
1556Z
1966-67 Door Hinge, Upper, LH



CH130
1966-67 Door Latch, RH
CH129
1966-67 Door Latch, LH



CH128
1970-72 Door Latch, RH
CH127
1970-72 Door Latch, LH



1556S
1968-72 Door Hinge, Lower, RH
1556T
1968-72 Door Hinge, Lower, LH



CH132
1968 Door Latch, RH
CH131
1968 Door Latch, LH



1556W
1966-67 Door Hinge, Lower, RH
1556X
1966-67 Door Hinge, Lower, LH



1556U
1968-72 Door Hinge, Upper, RH=LH



Doors & Hardware

1485Y

1968-72 Door Window Guide Plates

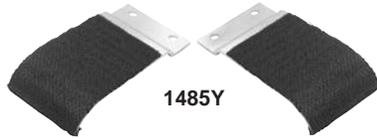

1485Y

1485N

1970-72 Front Door Glass Channel Support



1485N

1485P

1970-72 Door Glass Stopper



1485P

1485Q

1970-72 Door Window Guide Stabilizers



1485Q

1549R

1968 Quarter Window Regulator, Manual, RH

1549L

1968 Quarter Window Regulator, Manual, LH



1549L

1547R

1966-67 Manual Regulator, RH

1547L

1966-67 Manual Regulator, LH



1547R

1548R

1968-72 Manual Regulator, RH

1548L

1968-72 Manual Regulator, LH

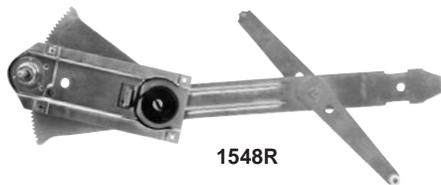

1548R

1485W

1968-72 Door Window Frame, RH

1485X

1968-72 Door Window Frame, LH



1485W

1076FE

1964-72 Door Lock Striker



M1390A

1964-72 Push Button Kit for Exterior Door Handles



M1390WB

1964-67 Exterior Door Handles w/ Button Kit



M1390

1964-67 Exterior Door Handles w/o Button Kit

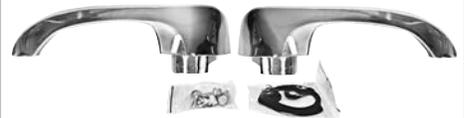

M1391

1968-72 Exterior Door Handles w/o Button, Pair



Doors & Hardware

M1604

1964 Interior Door Handle, Double Arm



M1605

1964 Interior Door Handle, Single Arm



M1037F

1965-67 Interior Door Handle, Standard



1404

1978-87 Door Outer Handle, RH

1405

1978-87 Door Outer Handle, LH



1406

1978-87 Door Inner Handle, RH

1407

1978-87 Door Inner Handle, LH

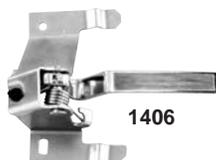

M1037D

1968-72 Interior Door Handle, Standard, RH

M1037E

1968-72 Interior Door Handle, Standard, LH



M1037D

M1392A

1964 Double Arm Window Crank, Black Knob (Malibu & SS)



M1392C

1964 Window Crank, Black Knob



M1392D

1964 Window Crank, Black Knob w/ Chrome Button



M1776

1965 Window Crank, Black Knob



M1382

1966-67 Window Crank, Chrome Knob



M1382A

1967 Window Crank, Black Knob



M1037A

1969-72 Window Crank, Black Knob



M1037B

1969-72 Window Crank, Clear Knob



M1392R

1964-72 Window Crank Gaskets, 4 Pcs.



Door Accessories

M1392J

1968-72 Vent Window Crank, Clear Knob



M1392K

1968-72 Vent Window Crank, Black Knob



M1392I

1966-67 Vent Window Handles



1463Y

1968-72 Vent Window Actuator, RH

1463Z

1968-72 Vent Window Actuator, LH



1463Y

Grilles & Components

M1364

1964 Standard Grille



M1364A

1965 Standard Grille



M1360

1966 Standard Grille



M1361

1966 "SS" Grille



M1362

1967 Standard Grille



Grilles & Components

M1363
1967 "SS" Grille



M1363B
1968 Standard Grille

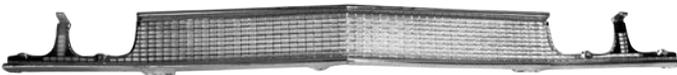

M1363C
1969 Grille w/ Molding Holes



M1363A
1969 Standard Grille w/o Molding Holes



M1365
1970 Standard Grille, Black



M1367
1971 Standard Grille

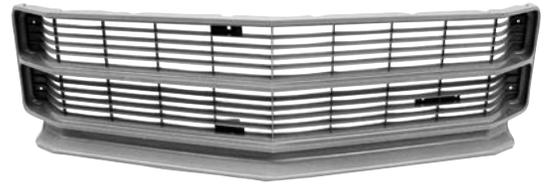

M1368
1972 Standard Grille



1432
1979 Grille Chrome / Argent (Excluding "SS")

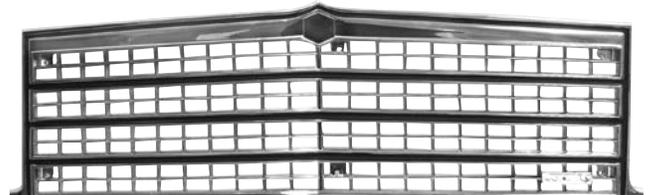

1444
1981 Standard Grille

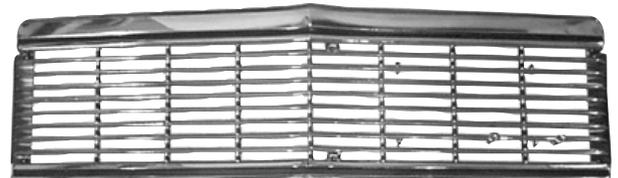

1445
1982-87 Standard Grille

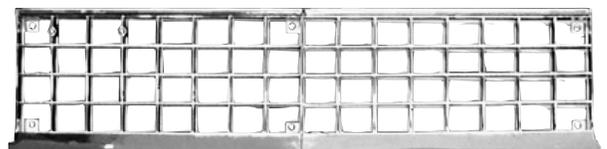

Grilles & Components

LH30

1964-70 Headlamp Mounting Buckets w/ Retaining Rings, 8 Pcs.

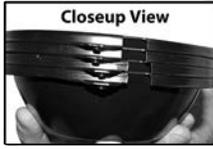

M1016

1971-72 Headlamp Retainer Ring



LH31

1964-70 Headlamp Retaining Rings, 4 Pcs.



M1384

1964 Headlamp Bezels, Pair



M1386

1967 Headlamp Bezels, RH

M1387

1967 Headlamp Bezels, LH



M1386

M1397A

1970 Headlamp Bezels, 4 Pcs.



M1384A

1965 Headlamp Bezels, Pair



M1388

1968 Inner & Outer Headlamp Bezels, RH

M1389

1968 Inner & Outer Headlamp Bezels, LH



M1388

M1398

1971 Chrome Headlamp Bezels, Pair



M1385

1966 Headlamp Bezels, Pair



M1396

1970 Inner & Outer Headlamp Bezels, RH

M1397

1970 Inner & Outer Headlamp Bezels, LH



M1396

M1399

1972 Chrome Headlamp Bezels, Pair



Grilles & Components

M1416X
1964 Eyebrow Moldings



M1416Y
1965 Eyebrow Moldings, 4 Pcs.

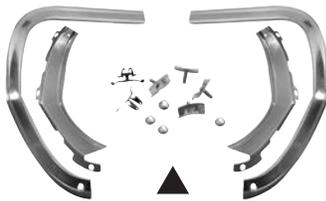

Hardware Close-up



M1416Z
1966 Eyebrow Moldings

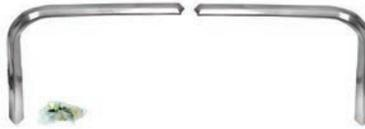

M1417
1968 Eyebrow Moldings



M1419
1969 Eyebrow Moldings, 300 DLX / "SS"
396



M1419A
1969 Eyebrow Moldings, Long



M1418
1965 Under Headlamp Molding



M1362F
1966 Lower Outer Grille Molding



M1366
1964 Grille Molding Upper



M1370
1966 Grille Molding, Lower Center w/ Clips



M1362C
1968 Grille Extension Moldings,
Pair



M1373
1969 Grille Molding, Lower



M1376
1969 Grille Molding, Lower, RH

M1377
1969 Grille Molding, Lower, LH



M1371
1969 Grille Molding, Center w/ Clips



Grille Molding continued on next page

Grilles & Components

M1362G

1969 Grille Molding, Outer
(Between Headlamps)



M1374

1970 Grille Molding, Outer, RH
(2 Per Side)

M1375

1970 Grille Molding, Outer, LH
(2 Per Side)



M1372

1970 Grille Molding, Inner (4 Per Car)



M1372A

1970 Grille Molding Kit for "SS" Grille, 10 Pcs.



M1378

1970 Grille Molding, Center (2 Per Car)



M1412

1971 Grille Molding Outer, RH

M1413

1971 Grille Molding Outer, LH



M1410

1971 Grille Molding Center (3 Per Car)



M1415

1972 Grille Molding Center, (2 Per Car)



M1414

1972 Grille Molding Upper



M1416

1972 Grille Molding, Lower



Grilles & Components

M1362E

1966 Outer Grille Extensions, Pair



M1362A

1967 Outer Grille Extensions, Pair



M1362B

1968 Outer Grille Extensions, Pair



M1362D

1969 Outer Grille Extensions, Pair



1448

1981 H/L Door Bezel, RH

1449

1981 H/L Door Bezel, LH



1450

1982-87 Headlamp Door Bezel, RH

1451

1982-87 Headlamp Door Bezel, LH



1487Z

1965 Upper Grille Plate



1487ZB

1967 Upper Grille Plate



1488P

1970-72 Upper Radiator Plate



Wiper Motor Trans. Arms

1418X
1964-65 Wiper Motor Transmission Arm



1400J
1966-67 Wiper Motor Transmission Arm



1400K
1968-72 Wiper Motor Transmission Arm



Hood Moldings & Spears

M1350
1964 Hood Lip Molding



M1351
1965 Hood Lip Molding



M1352
1966 Hood Lip Molding



M1353
1967 Hood Lip Molding



M1354
1968-69 Header Molding



M1422A
1968-72 Hood Rear Edge Molding, Standard



M1420
1970-72 Hood Cowl Rear Edge Molding



M1421
1970-72 Upper Rear Edge Fender Molding



M1393
1966 Hood Spear



Exterior Mirrors

M1035

1964-65 Round Head w/ "Bow-tie"



M1032

1966-68 Round Head w/ "Bow-tie"



M1032A

1966-67 Round Head w/o "Bow-tie"



3921816

1968 Remote Mirror, LH



M1030A

1968-69 Mirror Mounting Kit



M1030

1968-69 Standard Rectangular Head, RH

M1031

1968-69 Standard Rectangular Head, LH



M1034

1970-72 Standard Rectangular Head



Windshield Moldings

M1422

1964-65 Windshield Moldings, 5 Pcs.



M1423

1966-67 Windshield Moldings, 5 Pcs.



M1424

1968-72 Windshield Moldings, 3 Pcs.



Windshield Moldings continued on next page

Windshield Moldings

M1424A
1968-72 Lower Windshield Molding



Drip Rail Molding

M1429B
1964-67 Drip Rail Molding, RH

M1429C
1964-67 Drip Rail Molding, LH



M1429B

M1357
1964-67 Drip Rail Molding, 2 Pcs.



M1356
1968-72 Drip Rail Molding, 6 Pcs.



Wheel Opening Moldings

M1300
1964 Wheel Opening Molding, Front, RH

M1301
1964 Wheel Opening Molding, Front, LH



M1301

M1304
1964 Wheel Opening Molding, Rear, RH

M1305
1964 Wheel Opening Molding, Rear, LH



M1304

M1306
1965 Wheel Opening Molding, Front, RH

M1307
1965 Wheel Opening Molding, Front, LH



M1306

M1310
1965 Wheel Opening Molding, Rear, RH

M1311
1965 Wheel Opening Molding, Rear, LH



M1311

M1312
1966 Wheel Opening Molding, Front, RH

M1313
1966 Wheel Opening Molding, Front, LH



M1313

M1316
1966 Wheel Opening Molding, Rear, RH

M1317
1966 Wheel Opening Molding, Rear, LH



M1316

Wheel Opening Moldings

M1318

1967 Wheel Opening Molding, Front, RH

M1319

1967 Wheel Opening Molding, Front, LH



M1334

1970-72 Wheel Opening Molding, Rear, RH

M1335

1970-72 Wheel Opening Molding, Rear, LH



M1322

1967 Wheel Opening Molding, Rear, RH

M1323

1967 Wheel Opening Molding, Rear, LH



M1400

1978-87 Wheel Opening Molding, Front, RH w/o 2 Tone Paint

M1401

1978-87 Wheel Opening Molding, Front, LH w/o 2 Tone Paint

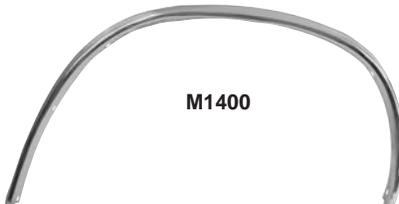

M1324

1968-69 Wheel Opening Molding, Front, RH

M1325

1968-69 Wheel Opening Molding, Front, LH



M1404

1978-87 Wheel Opening Molding, Rear, RH w/o 2 Tone Paint

M1405

1978-87 Wheel Opening Molding, Rear, LH w/o 2 Tone Paint



M1332

1970-72 Wheel Opening Molding, Front, RH

M1333

1970-72 Wheel Opening Molding, Front, LH



M1408

1978-87 Wheel Opening Molding, Rear, RH w/ 2 Tone Paint

M1406

1978-87 Wheel Opening Molding, Rear, LH w/ 2 Tone Paint



M1345

1969-72 Wheel Center Retainer



M1346

1969-70 Wheel Center



Body Side Moldings

M1475

1967 Body Side Moldings, 8 Pcs.



M1476

1968 Body Side Moldings, 8 Pcs.

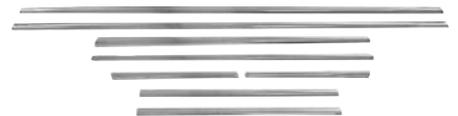

M1477

1969 Body Side Moldings, 8 Pcs.



*Body Side Moldings
continued on next page*

Body Side Moldings

M1470A

1967 Body Side Mldg, Clips, 64 Pcs.

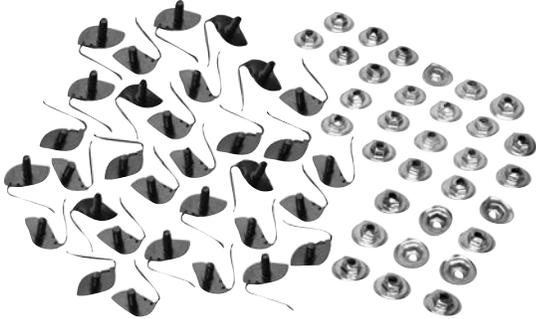

M1470B

1968-72 Body Side Mldg, Clips, 44 Pcs.



Rocker Mldgs.

M1433E

1966 Rocker Panel Extension Molding (Lower Rear), RH

M1433F

1966 Rocker Panel Extension Molding (Lower Rear), LH



M1433E

M1012A

1978-79 Rocker Panel Molding, RH=LH



R.Window Mldg.

M1427

1964-67 Rear Window Molding, 4 Pcs.



M1428

1968-72 Rear Window Molding, 5 Pcs.



Bed Moldings

M1383E

1964-67 Side Rail Bed Molding, RH=LH



M1383F

1968-72 Side Rail Bed Molding, RH=LH



M1383M

1968-72 Front Bed Molding



Vinyl Top Mldg.

M1464

1968-72 Vinyl Top Moldings



M1383

1964-67 Rear Bed Corner Moldings



Bed Moldings

M1383A

1968-72 Front Bed Corner Molding, RH

M1383B

1968-72 Front Bed Corner Molding, LH



M1383C

1968-72 Rear Bed Corner Molding, RH

M1383D

1968-72 Rear Bed Corner Molding, LH



M1383Q

1968-72 Rear Corner Molding Extensions



M1383N

1968-69 Rear Bed Corners, Upper / Outer



M1383P

1968-69 Rear Bed Corners, Lower / Outer



Tailgate Molding

M1383HCP

1964-67 Tail Gate Top Molding Clips, 4 Pcs.



M1383JCP

1968-72 Tail Gate Top Molding Clips, 4 Pcs.



M1383H

1964-67 Tail Gate Top Molding, Clips sold Separately



M1383J

1968-72 Tail Gate Top Molding w/o Clips



M1383R

1968-69 Tail Gate Molding, Lower w/ Clips



M1383S

1968-69 Tail Gate Molding, Upper w/ Clips



M1383T

1970-72 Tail Gate Molding, Lower w/ Clips



M1383U

1970-72 Tail Gate Molding, Upper w/ Clips



Emblems

EM4012

1964 "Chevrolet" Hood Letters

CHEVROLET

EM4216

1965 "Chevrolet" Hood Letters

CHEVROLET

EM4836

1967 "El Camino" Hood Emblem

ElCamino

EM4850

1968-69 "El Camino" Quarter Panel Emblems

elCamino
elCamino

EM4310

1966 "SS 396" Grille Emblem



EM1302

1969 "SS 396" Grille Emblem



EM4770

1972 "SS" Grille Emblem



EM1300

1967 "SS 396" Grille Emblem



EM1303

1970 "SS" Grille Emblem



EM4501

1968 "SS 396" Rear Panel Emblem



EM4500

1968 "SS 396" Grille Emblem



EM4743

1971 "SS" Grille Emblem



EM4755

1971-72 "SS" Rear Bumper Emblem
(Grey Letters)



Emblems

EM1304

1969-72 "SS" Fender Emblems



EM4620

1969-72 "SS" Fender Emblems
(2 Individual Letters), Chrome / White



EM4621

1969-72 "SS" Fender Emblems
(2 Individual Letters), Chrome / Black



EM4220

1965-67 "396 Turbo-Jet" Crossed Flags
Emblem



M1344

1970-72 "Cowl Induction" Emblem, 4 Pcs.



Exterior Electrical & Components

L64

1964 Parking Lamp Assembly, RH=LH



L65R

1965 Parking Lamp Assembly, RH

L65L

1965 Parking Lamp Assembly, LH



L65R

L66R

1966 Parking Lamp Assembly, RH

L66L

1966 Parking Lamp Assembly, LH



L66L

L67R

1967 Parking Lamp Assembly, RH

L67L

1967 Parking Lamp Assembly, LH



L67R

L68

1968 Parking Lamp Assembly, RH=LH



Back View

L69CR

1969 Parking Lamp Assembly, RH

L69CL

1969 Parking Lamp Assembly, LH



L69CR

L70B

1970 Parking Lamp Assembly, RH=LH



L64N

1964 Parking Lamp Lenses



*Parking Lamp Lenses
continued on next page*

Exterior Electrical & Components

L65N
1965 Parking Lamp Lenses



L66N
1966 Parking Lamp Lenses

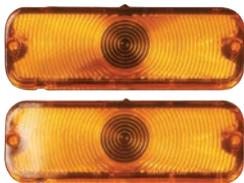

L67N
1967 Parking Lamp Lenses



L68N
1968 Parking Lamp Lenses



L69N
1969 Parking Lamp Lenses, Standard



L70BN
1970 Parking Lamp Lenses



L71BN
1971 Parking Lamp Lenses, Clear Front, Amber Side



L72BN1
1972 Parking Lamp Lenses, Amber



L72BN2
1972 Parking Lamp Lenses, Clear



TL64BN
1964 Tail Lamp Lenses



TL65BN
1965 Tail Lamp Lenses



TL66BN
1966 Tail Lamp Lenses



Exterior Electrical & Components

TL67BN
1967 Tail Lamp Lenses



TL70BN
1970-72 Tail Lamp Lenses



TU68N
1968 Back Up Lamp Lenses



CTL6869LED-R
1968-69 Tail Lamp Lenses, RH, L.E.D.
CTL6869LED-L
1968-69 Tail Lamp Lenses, LH, L.E.D.



CTL6869LED-R

TU64BN
1964 Back Up Lenses



TU69BN
1969-72 Back Up Lamp Lenses

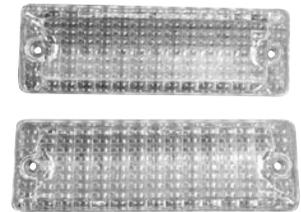

TL68BN
1968-69 Tail Lamp Lenses



TU65N
1965 & 1967 Back Up Lenses

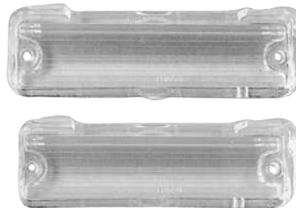

TU65
1965 & 1967 Back Up Lamp Assembly



CTL7072LED-R
1970-72 Tail Lamp Lenses, RH
CTL7072LED-L
1970-72 Tail Lamp Lenses, LH



CTL7072LED-R

TU66BN
1966 Back Up Lenses



TU68
1968 Back Up Lamp Assembly



Exterior Electrical & Components

M1618
1966-69 License Plate Lamp



M1618A NEW
1970-72 License Lamp



TU69RN
1969-72 Bumper Reflectors



TU69R
1969-72 Rear Bumper Reflector Assembly

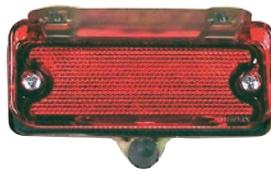

TL70BH
1970-72 Tail Lamp Housing, RH

TL70BK
1970-72 Tail Lamp Housing, LH



Reverse View

TL70BK

L71BZ
1971 Parking Lamp Bezels, Pair



L72BZ
1972 Parking Lamp Bezels, Pair



1702W
1964-66 Telescoping Antenna Mast

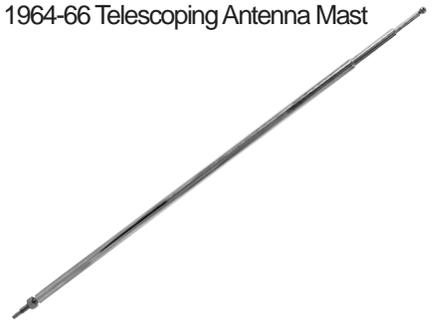

1000C
1967-69 Replacement Antenna Mast

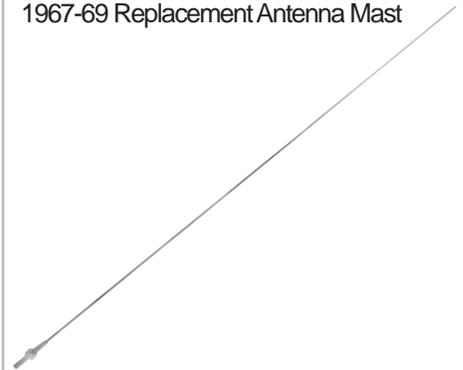

Glass & Weatherstripping

1485ME
1964-67 Rear Window Glass, Clear



Clear Glass

1485MG
1968-72 Rear Window Glass, Clear



Clear Glass

Glass & Weatherstripping

1400P

1968-72 Windshield Glass, Clear



1400PC

1968-72 Windshield Glass, Green Tinted



1485UD

1964-67 Door Window Glass, Clear, RH

1485TD

1964-67 Door Window Glass, Clear, LH



1485TE

1968-72 Door Window Glass, Clear, RH

1485UE

1968-72 Door Window Glass, Clear, LH



1485MC

1968-72 Door Window Assembly, Clear, RH

1485MD

1968-72 Door Window Assembly, Clear, LH



1418J

1964-65 Door Frame Weatherstrip

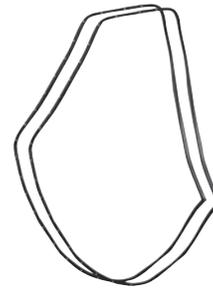

1418K

1966-67 Door Frame Weatherstrip

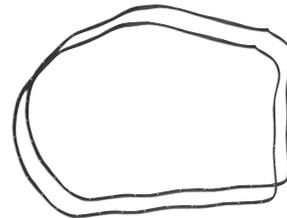

1418L

1968-72 Door Frame Weatherstrip



Heating/Cooling Components

1041W

1964-72 Heater Blower Motor w/o A/C

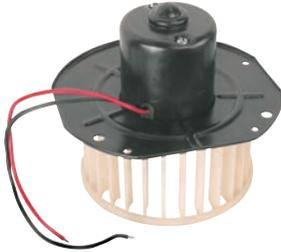

1400D

1969 A/C Heater Box Assembly

(Inside cab compartment)



1471B

1970-72 Air Vent Vacuum Motor Assy. w/ A/C

(Front view)



(Back view)

1041K

1964-72 Heater Box, Small Block w/o A/C

(Inside engine compartment)



1400F

1970-72 A/C Heater Box Assembly

(Inside engine compartment)



1400W NEW

1969-70 A/C Hose



1041L

1968-70 Heater Box, Big Block



1400G

1970-72 A/C Plenum



Heater box NOT included.

1400X NEW

1971-72 A/C Hose



1400

1968-72 Evaporator Box

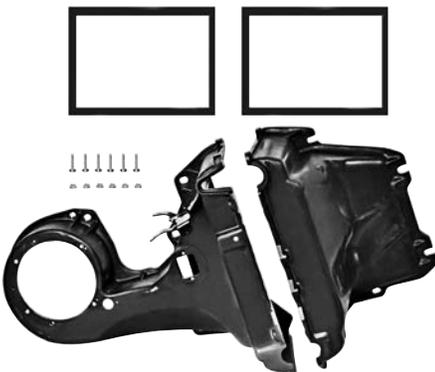

1452B

1970-72 Lap Cooler w/ Air Diverter

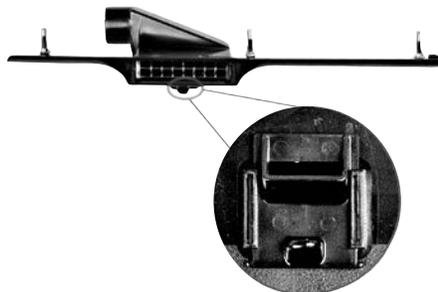

1456

1971-72 A/C & Heater Control

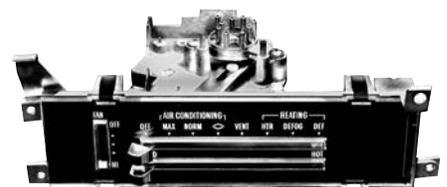

Pedal & Shifter Components

1495B NEW
1964-67 Parking Brake Control

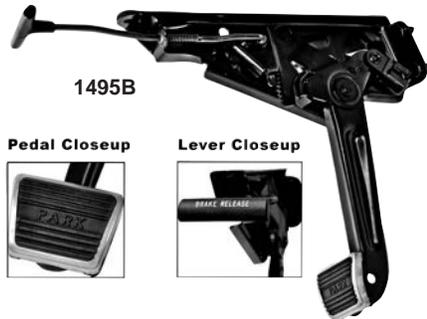

1495
1969 Parking Brake Control



1495A
1970-72 Parking Brake Control



M1339
1964-67 Brake Release Handle



1403A
1970-72 Brake Release Handle



1006PC NEW
1964-77 Brake & Clutch Pedal
Pivot Retainer

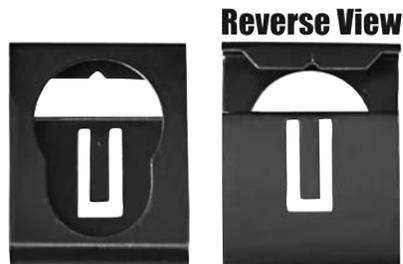

3893181
1964-69 Parking Brake Pad
3893182
1964-69 Parking Brake Pad Trim



M1726G
1964-67 Accelerator Pedal
M1726H
1964-67 Accelerator Pedal Trim



K919
1968-72 Accelerator Pedal
K912
1968-72 Accelerator Pedal Trim

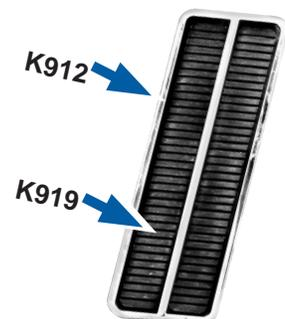

Pedal & Shifter Components

1499G

1968-72 Console Door Top Plate, Auto



M1582

1968-70 Console Trans. Indicator Insert for Automatic, Green Letters
(Also Fits 1970 Monte Carlo)



1498F

1966-67 Shift Base, Automatic 3-speed



1498E

1966-67 Shift Base, Automatic 4-speed



1499

1968-69 Accelerator Pedal Assembly



M1583

1971-72 Console Trans. Indicator Insert for Automatic, White letters
(Also Fits '71-'72 Monte Carlo)



1498J

1966-67 Shift Assembly w/ Handle, Automatic 3-Speed



1499A

1970-72 Accelerator Pedal Assembly



1498G

1964-67 Shifter Lever w/ Button, Automatic Transmission



1498K

1966-67 Shift Assembly w/ Handle, Automatic 4-speed



Pedal & Shifter Components

1497
1968-72 Shifter Assembly, 5 Pcs.

Complete kit with shifter, rods and brackets.



1498B
1968-72 Shift Cable, Automatic w/ Floor Shifter



1498
1968-72 Shift Lever, w/o Console



1498A
1968-72 Shift Lever, w/ Console



1498L
1968-72 Shift Lever, Automatic, (Also '70-'72 Monte Carlo)



1499D
1968-72 Shift Assembly w/ Handle, Automatic, 4-Speed



1403
1966-67 Console Shift Boot Retainer



1495Z
1968-72 Clutch Rod Boot



Center Shroud

3939760
1969-70 Wheel Center Shroud, Black



Steering Wheel Hubs

M1336
1967-68 Steering Wheel Hub, 3 15/16" Diameter x 1 7/8" Tall



M1337
1969-72 Steering Wheel Hub, 4 1/8" Diameter x 1 3/16" Tall



Steering Wheel

9745764

1967 Steering Wheel, DLX SS



9746195

1967-68 Steering Wheel, Walnut



9747536

1968 Steering Wheel, Black



3960722

1969 Steering Wheel, Rosewood



3939731

1969-70 Steering Wheel, Black



SW12

1969-70 Steering Wheel, Three Spoke Comfort Grip

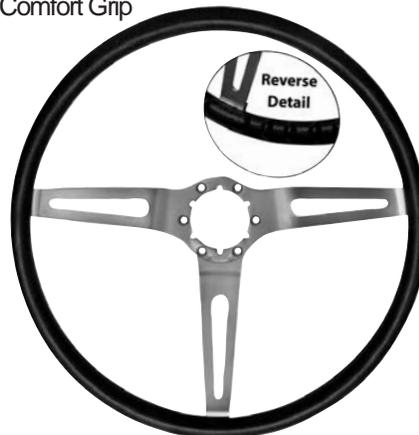

R. View Mirrors, Visor Supports

916177

1964-67 8" Rear View Mirror



911366

1964-67 10" Rear View Mirror



M1035C

1964-67 Standard Rear View Mirror



M1035A

1969-72 12" Rear View Mirror



R. View Mirrors, Visor Supports

M1035E

1964-65 Rear View Mirror Bracket



M1035F

1966 Rear View Mirror Bracket



M1034A

1971-72 Rear View Mirror Bracket Boot



M1338

1964-72 Sun Visor Support Bracket,
(Also 1970-72 Monte Carlo)



Headliner Mldg.

M1460E

1964-67 Front Headliner Molding



M1460K

1964-67 Rear Headliner Moldings, 6 Pcs.



Door Trims & Arm Rests

M1429

1964-67 Door Frame Moldings, 4 Pcs.

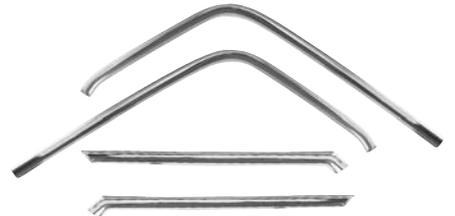

M1429A

1968-72 Door Frame Moldings, 4 Pcs.



M1357A

1966-67 Door Edge Moldings

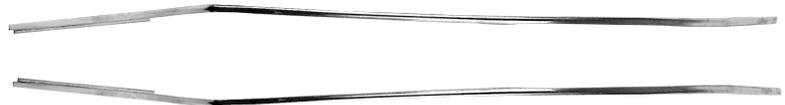

M1358

1968-72 Door Edge Moldings



Door Trims & Arm Rests

M1770

1964-66 Door Lock Knobs, Black, Pair



M1771

1964-66 Door Lock Knobs, Chrome, Pair



M1772

1967 Door Lock Knobs, Black, Pair



M1773

1967 Door Lock Knobs, Chrome, Pair



M1777

1968 Door Lock Knobs, Black, Pair



M1774

1968-69 Door Lock Knobs, Chrome, Pair



M1775

1970-81 Door Lock Knobs, Chrome, Pair



1485G

1968-72 Door Bumpers, 2 Pcs. Set



1485H

1970-72 Door Jamb Vent Grille



M1602

1964-67 Arm Rest Bases, Chrome, Pair



M1040

1968-72 Arm Rest Base, Black, RH

M1040A

1968-72 Arm Rest Base, Black, LH



M1040B

1968-72 Arm Rest Bases, Red



M1040C

1968-72 Arm Rest Bases, Medium Blue



M1040D

1968-72 Arm Rest Bases, Ivy Gold



M1040E

1968-72 Arm Rest Bases, White



M1040F

1968-72 Arm Rest Bases, Dark Blue



M1040G

1968-72 Arm Rest Bases, Dark Green



Door Scuff Plates

M1340

1964-67 Scuff Plate, RH=LH, w/o Ribs



M1340A

1964-67 Scuff Plates, RH=LH, Stainless w/o Ribs



M1341

1964-67 Scuff Plate, RH=LH, w/ Ribs



M1341A

1964-67 Scuff Plates, RH=LH, Stainless w/ Ribs



M1342

1968-72 Scuff Plate, RH

M1343

1968-72 Scuff Plate, LH

M1342



M1342A

1968-72 Scuff Plate, Stainless



Trim Panels

1451E

1967 Floor Trim Panel



1451F

1968-72 Floor Trim Panel

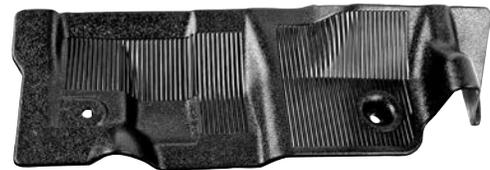

Interior Hooks

GM01

1964-72 Clothes Hanger, 2 Pc. Set



GM02

1964-72 Shoulder Harness Hooks

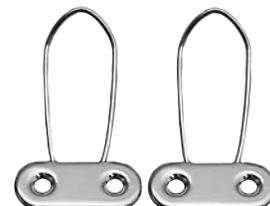

Kick Panels

1438
1967 Kick Panel (No A/C), RH

1439
1967 Kick Panel (No A/C), LH



1440
1968-72 Kick Panel Assembly, Pair



Seats & Components

1401
1966-68 Seat Assembly, RH
DYNACORN EXCLUSIVE!

1402
1966-68 Seat Assembly, LH
DYNACORN EXCLUSIVE!



1401

1402A
1969-72 Seat Assembly, RH=LH,
(Also Fits 1970-72 Monte Carlo)

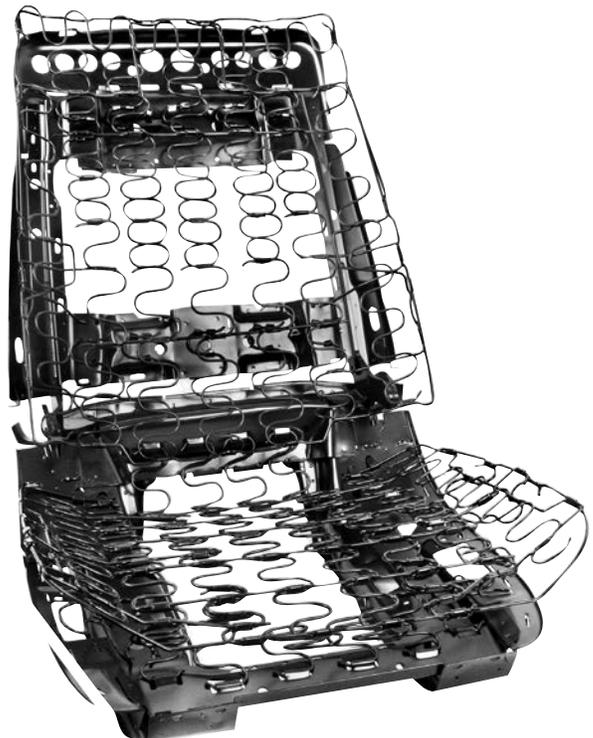

Seats & Components

1402N
1964-65 Seat Back Spring

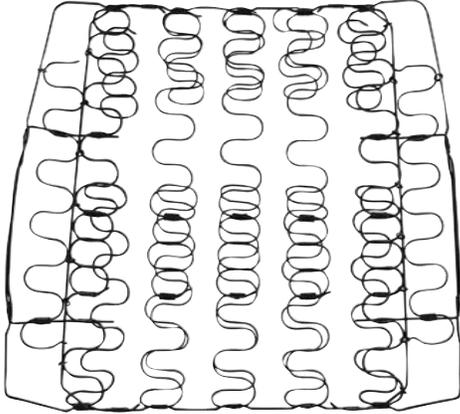

1402M
1964-65 Seat Bottom Spring

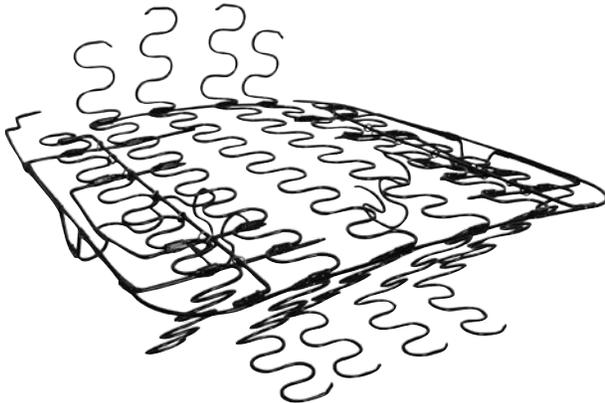

1402L
1966-72 Front Seat Back Spring

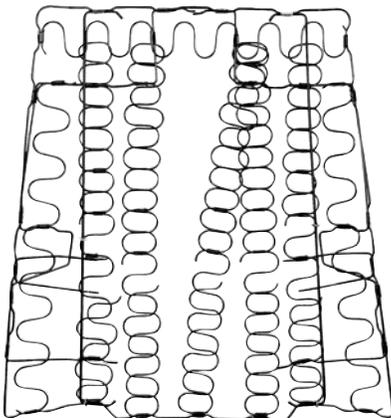

1402P
1966-72 Seat Side Support Spring, 4 Pc+ 8 Clip

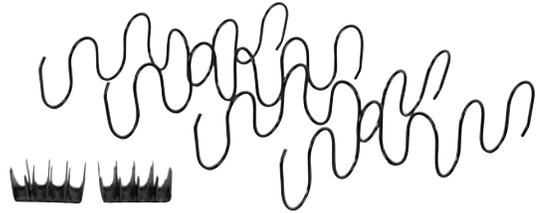

1402K
1966-72 Seat Bottom Spring, RH=LH

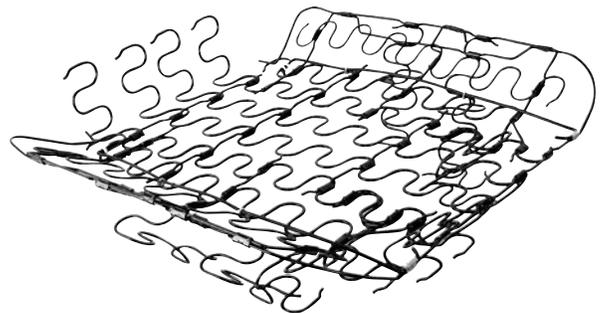

1560
1966-67 Seat Track Assembly, RH

1561
1966-72 Seat Track Assembly, LH

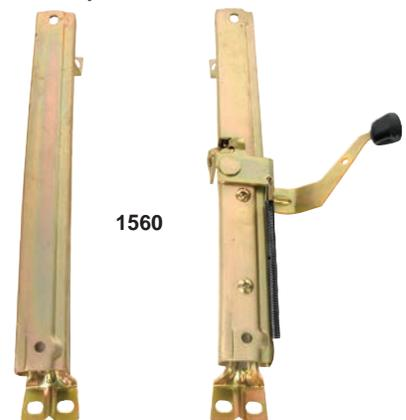

Seats & Components

M1392P

1967-68 Bucket Seat Release Button



K883G

1968-72 Belt Buckle Cover w/ GM Insert



Magnum Alloy Wheels

CAPS or CAPT

Magnum Alloy Wheel Cap w/ Decal, Short Style or Tall Style (Fits FW & GW Series Wheels)



GW157P NEW

Magnum Alloy Wheel 15"x7" New Design w/ Center Cap, 4" Backspace *Improved Tooling & Finish*

GW158P NEW

Magnum Alloy Wheel 15"x8" New Design w/ Cap, 4." Backspace

4.3/4" Bolt Pattern

Tall-Style Wheel Cap included with all 15" Rims



4.3/4" Bolt Pattern

Tall-Style Wheel Cap included with all 15" Rims



Seat Belts



**Seat Belts with Push Button:
6 colors to choose from**



60 Inch Belts

SB-N2PB	Seat Belt with Push Button	Black
SB-N2PG	Seat Belt with Push Button	Grey
SB-N2PT	Seat Belt with Push Button	Tan
SB-N2PN	Seat Belt with Push Button	Navy Blue
SB-N2PR	Seat Belt with Push Button	Red
SB-N2PM	Seat Belt with Push Button	Maroon



Retractable with 12 " Sleeve & 7" Boot



SB-R2PB	Seat Belt with Push Button	Black
SB-R2PG	Seat Belt with Push Button	Grey
SB-R2PT	Seat Belt with Push Button	Tan
SB-R2PN	Seat Belt with Push Button	Navy Blue
SB-R2PR	Seat Belt with Push Button	Red
SB-R2PM	Seat Belt with Push Button	Maroon



SB-90BR

SB-20FLP	20" Webbing Chrome Push Buckle Black. (Chevy Pu Bench Seat)	Black
SB-90BR	90 Degree End Bracket	



**Seat Belts with Lift Latch:
10 colors to choose from**

60 Inch Belts

SB-N2LB	Seat Belt with Lift Latch	Black
SB-N2LG	Seat Belt with Lift Latch	Grey
SB-N2LM	Seat Belt with Lift Latch	Maroon
SB-N2LN	Seat Belt with Lift Latch	Navy Blue
SB-N2LR	Seat Belt with Lift Latch	Red
SB-N2LT	Seat Belt with Lift Latch	Tan



Retractable with 12 " Sleeve & 7" Boot

SB-R2LB	Seat Belt with Lift Latch	Black
SB-R2LG	Seat Belt with Lift Latch	Grey
SB-R2LM	Seat Belt with Lift Latch	Maroon
SB-R2LN	Seat Belt with Lift Latch	Navy Blue
SB-R2LR	Seat Belt with Lift Latch	Red
SB-R2LT	Seat Belt with Lift Latch	Tan

3 Points Retractable Shoulder Belt



SB-R3LB	Retractable 3 Point Seat Belt with Chrome Latch	Black
SB-R3PB	Retractable 3 Point Seat Belt with Push Button	Black
SB-R3PG	Retractable 3 Point Seat Belt with Push Button	Gery
SB-R3PT	Retractable 3 Point Seat Belt with Push Button	Tan
SB-R3PN	Retractable 3 Point Seat Belt with Push Button	Navy Blue
SB-R3PR	Retractable 3 Point Seat Belt with Push Button	Red

Interior Electrical

1010HC **NEW**

1964-72 Horn High + Low Note Chrome Plated
w/ Mounting Bracket and Hardware



1010U

1964-77 Horn Set w/ Universal Brackets, 6 Pcs.



1010H

1964-72 Horn High

1010L

1964-72 Horn, Low



1010H

M1013B

1970 Headlamp Switch



M1013

1964-72 Headlamp Switch



LH01A **NEW**

1973-79 Headlamp Switch

Reverse View

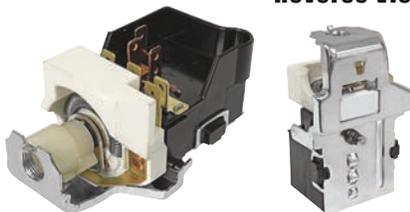

LH01

1964-72 Headlamp Dimmer Switch



PYU79 **NEW**

1978-87 Headlamp Dimmer Switch

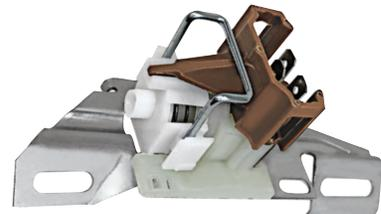

7031884

1967 Cigarette Lighter



Interior Electrical

GF1085 *NEW*

1969-83 Ignition Switch w/o Tilt



GF1086 *NEW*

1969-83 Ignition Switch w/ Tilt

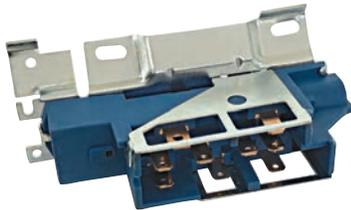

1702Q

1965 Windshield Wiper Switch



LH47

1967 Windshield Wiper Switch, 2-Speed



LH52

1969-71 Windshield Wiper Switch
(w/o Recessed Park)



M1440B

1964-67 Dome Light Lens



M1440C

1968-87 Dome Light Lens



M1440E

1964-67 Dome Light Base



Bushings

M1452

1964-67 Body Bushings, 10 Pcs.



M1450

1965-67 Radiator Support Bushings



M1451

1968-72 Radiator Support Bushings



Sill Decal

FL01

1964-72 "Body by Fisher" Decal



Ignition, Door & Glovebox Locks

CL-382

1964 Ignition, Door, & Glove Box Locks (Keyed Alike)



CL-384

1966-67 Ignition, Door, & Glove Box Locks (Keyed alike)



CL-383

1965 Ignition, Door, & Glove Box Locks (Keyed Alike)



CL-387

1970-76 Ignition, Door, & Glove Box Locks (Keyed Alike)



Ignition, Door & Glovebox Locks

CL-388

1977 Ignition, Door, & Glove Box Locks (Keyed Alike)



158A

1965 Original, Octagon Head Key



Ignition Locks

157

1964 Octagon Head Key



161

1964 Original, Octagon Head Key



158

1965 Octagon Head Key



100

1966-67 Later, Square Head Key



100A

1966-67 Original, Octagon Head Key



101

1968 Later, Square Head Key



Ignition Locks

101A

1968 Original, Octagon Head Key



102

1969-78 Later, Square Head Key



CL-955

1964-72 Key-less



CL-960

1964-72 Key-less, Brushed Stainless



145

1964-65 Later, Round Head Key



Glovebox Locks

145A

1964-65 Original, Pear Head Key



146

1966-67 Later, Round Head Key



146A

1966-67 Original, Pear Head Key



Glovebox Locks

119A
1968 Original, Pear Head Key



119
1968-69 Later, Round Head Key



120
1970-77 Later, Round Head Key

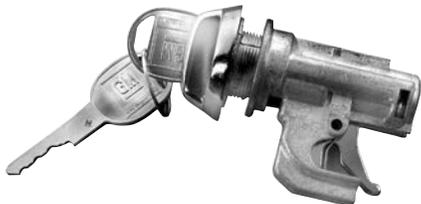

142A
1964 Original, Octagon Head Key



143A
1965 Original

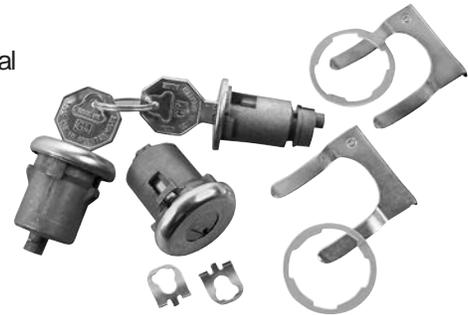

104
1966-67 Later, Square Head Key



Ignition & Door Lock Kits

142
1964 Square Head Key



104A
1966-67 Original, Octagon Head Key



Ignition & Door Lock Kits

105

1968 Later, Square Head Key



105A

1968 Original, Octagon Head Key



106

1969-78 Later, Square Head Key

